

March 2021

Installation and Operation Manual

Blackmagicdesign 

Blackmagic Video Assist



Blackmagic Video Assist



Welcome!

Thank you for purchasing your Blackmagic Video Assist.

In 2015 we launched the original Blackmagic Video Assist to help you shoot better quality video on any type of camera. We are now excited to introduce Blackmagic Video Assist 12G HDR to the video assist family!

We are extremely excited to have designed the Blackmagic Video Assist family of products. We think they are the perfect solution to help you shoot better video on any type of camera. Your video assist combines the best of our monitoring and recording technologies for on set monitoring and professional recording into easy to use very compact products.

Blackmagic Video Assist models can be mounted on your camera, or on a desk for general deck and monitoring use. That's perfect for use as a master recorder for a live production switcher like ATEM Mini.

3G-SDI and 12G-SDI inputs let you monitor HD or Ultra HD on high quality LCD screens including HDR on 12G models. With up to 2,500 nits, the HDR displays can be seen even in bright sunlight.

You can record on fast SD cards including dual card slots on the 7" models for continuous recording. Your video assist is a very versatile monitor and recorder you can use with any camera on any project.

This instruction manual contains all the information you need to start using your Blackmagic Video Assist.

Please check the support page on our website at www.blackmagicdesign.com for the latest version of this manual and for updates to your video assist's software. Keeping your software up to date will ensure you get all the latest features! When downloading software, please register with your information so we can keep you updated when new software is released. We are continually working on new features and improvements, so we would love to hear from you!

A handwritten signature in black ink that reads "Grant Petty". The signature is written in a cursive, flowing style.

Grant Petty

CEO Blackmagic Design

Contents

Getting Started	5	Checking Disk Speed	53
Plugging in Power	5	Using Video Assist as a Webcam	54
Plugging in Video	7	Setting the Webcam Source	55
Plugging in Audio	7	Using Open Broadcaster	55
Inserting SD Cards	7	Blackmagic Video Assist Setup	57
Recording	8	Updating the Internal Software	57
Remote Control via the LANC Connector	9	Using DaVinci Resolve	58
Continuous Recording	9	Project Manager	59
Recording Clean HDMI from DSLR Cameras	10	Editing with the Cut Page	60
Playback	10	Adding Clips to the Timeline	62
Looping playback	11	Editing Clips on the Timeline	64
Changing Settings	11	Adding Titles	64
Using the Touchscreen	11	Working with Blackmagic RAW Files	65
Blackmagic Video Assist Settings and Features	13	Color Correcting your Clips with the Color Page	68
Audio	31	Adding a Power Window	71
Menu Settings	33	Using Plugins	73
Entering Metadata	37	Mixing Your Audio	74
Digital Slate	37	Adding VFX and Compositing on the Fusion Page	79
Recording Blackmagic RAW on Video Assist 12G HDR	42	Mastering Your Edit	87
Connecting your camera to Video Assist 12G HDR	42	Quick Export	87
Blackmagic RAW	44	The Deliver Page	88
Recording to Blackmagic RAW	45	Post Production Workflow	88
Storage Media	47	Working with 3rd Party Software	88
Choosing a Fast SD Card	47	Using Final Cut Pro X	89
Choosing a USB-C Flash Disk	49	Using Avid Media Composer 2018	89
Formatting Storage Media using your Video Assist	50	Using Adobe Premiere Pro CC	90
Formatting Media using a Computer	51	Help	91
Working with Files from SD Cards	53	Regulatory Notices	92
		Safety Information	93
		Warranty	94

Getting Started

This section shows you how to get started including:

- Plugging in Power
- Plugging in Video
- Plugging in Audio
- Inserting SD cards

Plugging in Power

Getting started with your Blackmagic Video Assist is as simple as plugging in power, connecting your video source, plugging in your audio and inserting an SD card.

To supply power, plug in the supplied power adapter to your video assist's power input on the right side panel. On the 12G models, you can secure the connector to the video assist to prevent accidental disconnection.

To power on the unit, press the power button on the right side panel. Press and hold to power off.

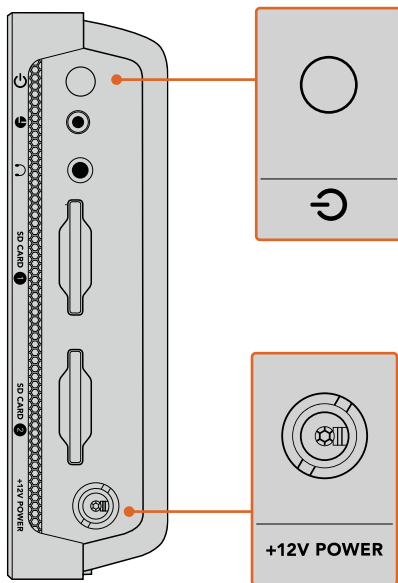

Connect external power to the +12V power input. Press the power button to turn the unit on.

TIP The supplied power cable included with Blackmagic Video Assist 12G HDR features a locking connector to prevent disconnection, but you can also use any 36W 12V power cable to power the video assist.

You can also power your video assist using Sony L-series batteries that are very common and can be purchased in a variety of capacities.

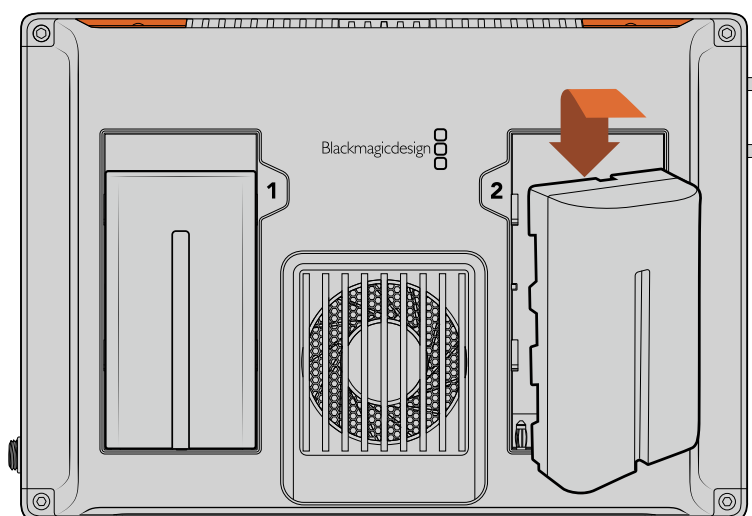

Insert the battery into the slot and slide down until it clicks into place. To remove, press and hold the button above the battery and slide the battery out

Charging your Batteries

L-series batteries are very common and used in a variety of video equipment. This also means there is a wide variety of chargers you can use to recharge your batteries. These include a wall plug style charger with a single battery slot, or dual slot models with an LCD screen that displays the charge status of your batteries. When selecting a battery charger, it's important to make sure it fits into your production workflow. For example, some chargers are powered via USB so are convenient for when you are on the go. Other chargers are mains powered so will suit studio and office locations.

The first time you power up your Blackmagic Video Assist you will be prompted to select your language from the 11 available options. Tap on your selected language and then tap 'update'. You can change your language settings at any time using the 'setup' tab of the dashboard menu.

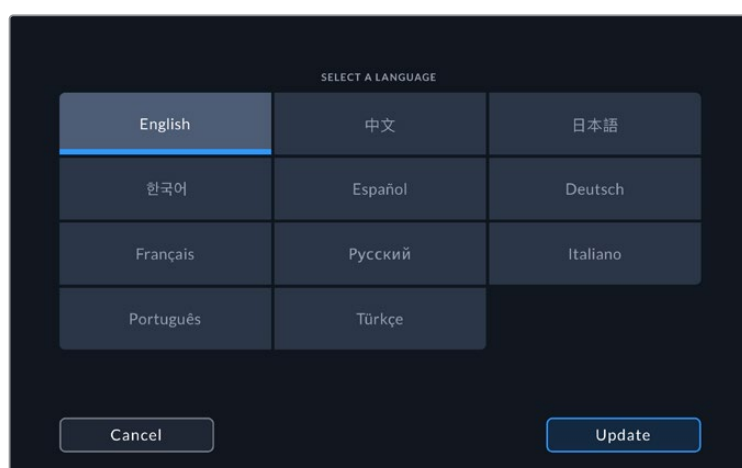

Plugging in Video

The next step is to plug your SDI or HDMI source video into the Mini BNC, BNC or HDMI input. Mini BNC to regular BNC cables can be purchased from your nearest professional video equipment stores.

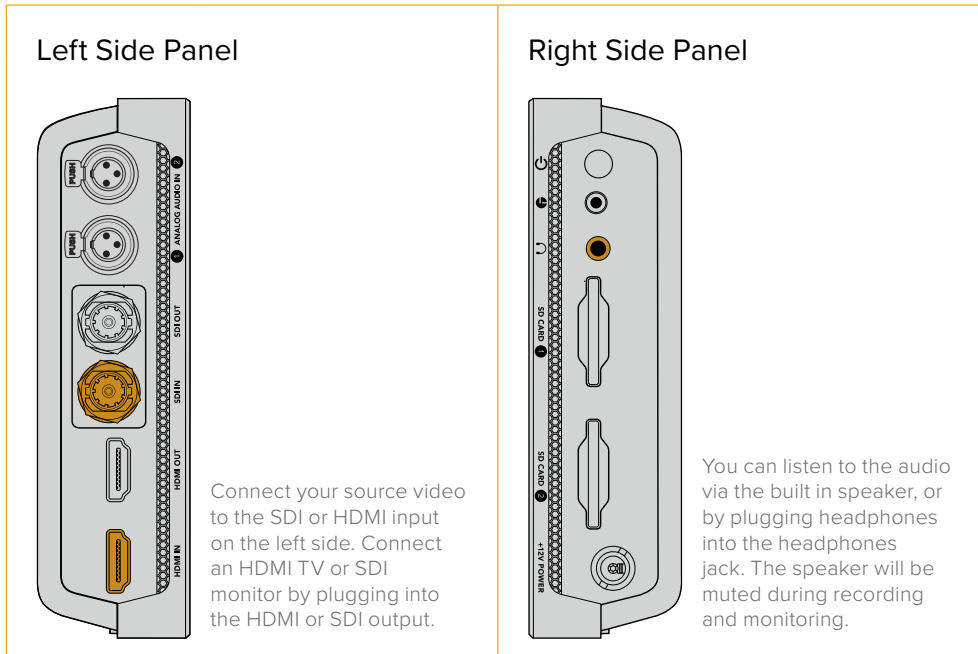

Plugging in Audio

When plugging in your video, audio is also connected as it's embedded in the SDI or HDMI video signal. However, 7" video assist models also have built in mini XLR connectors so you can plug in external balanced analog audio as well.

NOTE On the 7" video assist model, you can set the audio settings to record analog channels 1 and 2, or choose one channel analog audio and one channel SDI or HDMI audio, depending on your source video. For more information about analog audio and adjusting levels refer to the 'audio' section later in this manual.

Inserting SD Cards

To start recording clips, first insert a compatible SD card.

For high quality HD recording, we recommend high speed UHS-I SD cards. However, if you are recording standard definition or lower bit rate, lower quality compression you might be able to use slower cards. Generally, the faster the cards the better.

If you are recording Ultra HD, then we recommend high speed UHS-II type SD cards.

For Blackmagic Video Assist 12G HDR these cards need to be capable of write speeds above 224MB/s for recording up to ProRes HQ Ultra HD 2160p60.

The 7" video assist models also have two SD card slots. You can record to either one, or insert two SD cards for continuous recording or fast media change overs.

Before using your cards, you will need to format them to either HFS+ or exFAT formats. It's easy to format your media via the 'storage' settings. For information on formatting, refer to the 'storage media' section for more later in this manual.

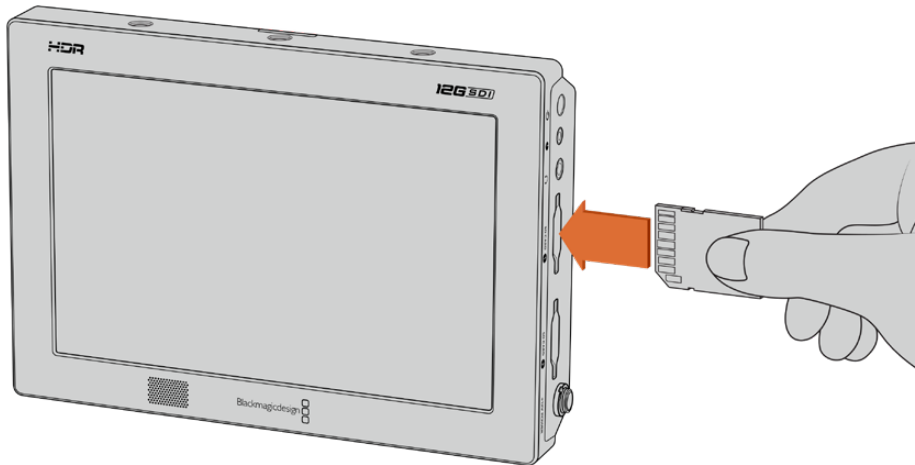

To start recording you'll need to insert an HFS+ or exFAT formatted UHS-I or UHS-II SD card. You can easily format your SD card using the 'storage' settings in the touchscreen menu.

That's all there is to getting started. With power, video and a formatted SD card you can now start recording!

Recording

To start recording straight away, simply tap the circular 'record' icon at the bottom of the LCD. Tap the stop icon to stop recording.

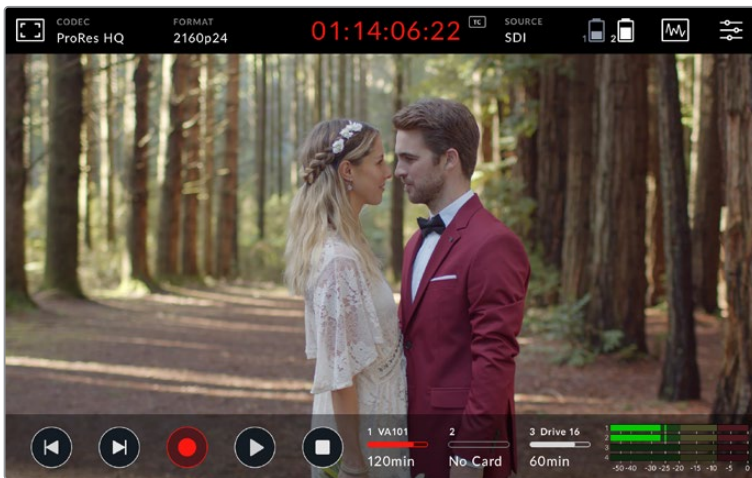

The timecode display in the upper toolbar will illuminate red while recording

Clips can be recorded using Apple ProRes and Avid DNx codecs.

You can also set your video assist to use 'timecode' or 'SDI/HDMI start/stop' trigger recording.

TIP When the upper and lower toolbars are hidden on your 5" video assist, a small record indicator will be displayed at the bottom of the LCD so you can easily confirm you're recording. Swiping the screen up or down brings the toolbars back in view.



On 5" video assist models, swipe the screen up or down to reveal or hide the toolbars.

NOTE When recording from an HDMI or SDI camera, make sure the output is clean with overlays turned off as any overlays that are present in your camera's video output will be recorded with your image. Please refer to the section titled 'recording clean HDMI from DSLR cameras' for more information.

Remote Control via the LANC Connector

On 7" video assist models you can start and stop recording remotely using an external LANC controller. Simply plug the LANC controller into the 2.5mm LANC input on the right side of the unit.

Continuous Recording

7" video assist models support continuous recording when using more than one card, or on an external drive for 12G video assist models via the USB-C port. If you are recording an important event and you don't want to stop recording, simply insert a second SD card or connect an external drive. Once your current card or drive is full, the recording will automatically spill over to the next slot. There will be no frames dropped in the process. For example, if the first segment on card 1 stopped at 00:40:01:00, the recording on the second card will start at 00:40:01:01.

When editing your clips on the timeline, simply place the second clip against the tail of the first and they will play through the recording as if it is one complete clip.

Having an additional card or drive connected also lets you quickly change media. If you want to switch to another card or the active drive, simply hold down the 'record' button. The recording will spill over to the next available slot without missing a frame. Now you can remove the first card or drive and start using the media right away!

TIP For continuous recording or fast slot change overs, make sure your cards are formatted before you start your recording. You can format your SD card or external drive while recording on another slot, simply tap on the storage indicators to reveal the storage settings. See the 'storage media' section later in this manual for further information on formatting.

Recording Clean HDMI from DSLR Cameras

Some DSLR cameras record 8-bit video internally, and some can provide a clean video image via their HDMI output. By plugging the DSLR camera's HDMI output into your video assist, you can bypass the camera's internal compression and record using high quality 10-bit ProRes or Avid DNx codecs. Some DSLR cameras can output 10-bit 4:2:2, which is higher quality video than their internally recorded 8-bit 4:2:0 compression.

Many DSLR cameras are also limited to short recording durations, so an added benefit of recording externally is bypassing these recording limitations. This is particularly helpful when recording live events or interviews for documentaries.

To make the most of this feature, you will need to set your camera to output a clean image with overlays turned off. This is normally done by changing your DSLR camera's HDMI output settings so it does not show any status information in the video signal. This is important because if there are any overlays visible in your image via the HDMI output they will be recorded in your video, which you probably don't want.







To check the DSLR camera overlays are not visible:

- 1 Swipe the touchscreen up or down to hide the on screen meters so you can monitor only your DSLR camera's image. On 7" video assist models the upper toolbar at the top of the LCD is independent and separate from the image. This means you can monitor the entire image cleanly and still have the upper toolbar visible.
- 2 With the on screen meters hidden, carefully check the DSLR camera's output video does not show any information other than your clean video image. If you can see camera overlays on your video assist's LCD, change the HDMI output or display menu settings on your camera so HDMI overlays are turned off.

With a clean HDMI output from your camera you can now record better quality video!

Playback

The transport controls can be found on the lower toolbar. If your lower toolbar is hidden from view, simply swipe the screen up or down to reveal it.

Play		To play your clips, tap the 'play' icon.
Stop		During playback, tap the 'stop or 'pause' icon to momentarily 'freeze' playback on a frame of video.
Skip	 	You can skip backwards or forwards through your clips by repeatedly tapping the forward or reverse skip icons. Tapping reverse skip once will restart the current clip.
Shuttle	 	Hold down one of the skip buttons to change into shuttle mode. Now you can fast forward or rewind by tapping either shuttle button through speeds from x1/2 to x50. Press the stop or play button to revert the buttons back to skip mode.

TIP Scrub clips forwards or backwards by dragging the scrubbing slider left or right, or by swiping the screen to jog through the video.



Jog forwards or backwards by swiping the video left or right.

You can choose to display skip buttons or the histogram in the lower toolbar. When the ‘display histogram’ option in the setup tab of the dashboard menu is switched ‘on’, only the ‘record’, ‘play’ and ‘stop’ buttons will be visible.

Looping playback

Loop		Once your clip is playing, press the ‘play’ button again to set your video assist to play the current clip on a continuous loop.
Loop all		Tap ‘play’ again to play all your recorded clips on a continuous loop.
Play		Tap again to return to real time playback.

When in loop mode, the timeline will zoom in to the active clip. Now you have greater control to scrub through the clip using the playhead.

Changing Settings

Using the Touchscreen

All video assist models come with a great range of features and user adjustable settings. The main display features upper and lower toolbars. The upper toolbar provides access to monitor overlays, codec, format, source settings, scopes and the dashboard menu, as well as a timecode display and battery status indicators.

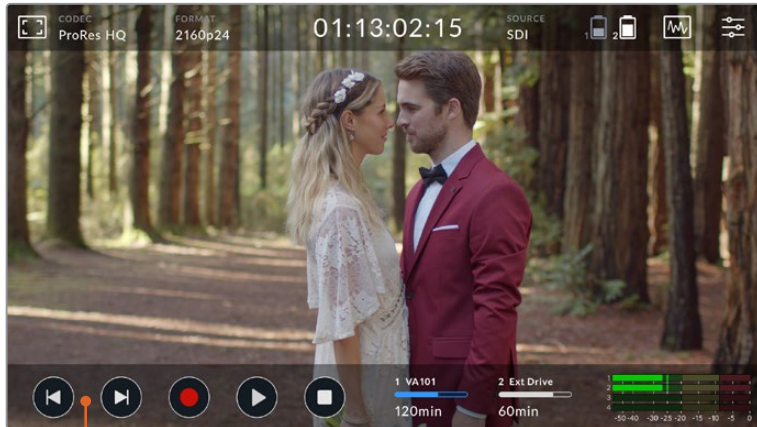

The lower toolbar includes transport controls, storage indicators and audio meters. A display histogram can also be turned on via the menu to appear over the skip buttons on the lower left of the toolbar.

TIP Both toolbars on the 5” video assist models can be removed from view by swiping the screen up or down. On the 7” models, the upper toolbar will remain in view at all times.

The tabbed dashboard menu is accessed via the settings icon on the upper toolbar and features record, monitor, setup, and LUTs tabs. The 7” models also include an audio tab so you can access the additional XLR channel input settings.

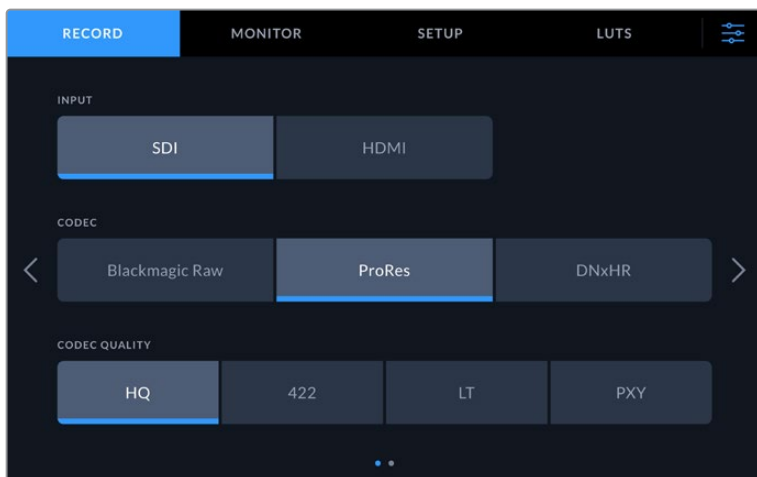

Navigate between the pages by swiping from left to right or tapping the arrows on either side

Each menu tab features two or more pages of options you can navigate by swiping the screen left or right, or by tapping the arrows on either side. When selecting the codec or source icons in the upper toolbar, you will open up the record tab of the menu.

Blackmagic Video Assist Settings and Features

Your video assist displays overlays on the LCD to help with exposure, focus, composition and framing when connected to a camera.

These settings can be accessed via the 'monitor overlay' icon in the top left corner of your video assist. You can also use the 'monitor' tab of the dashboard menu to toggle these settings on or off individually, or disable them all by selecting 'clean feed'.

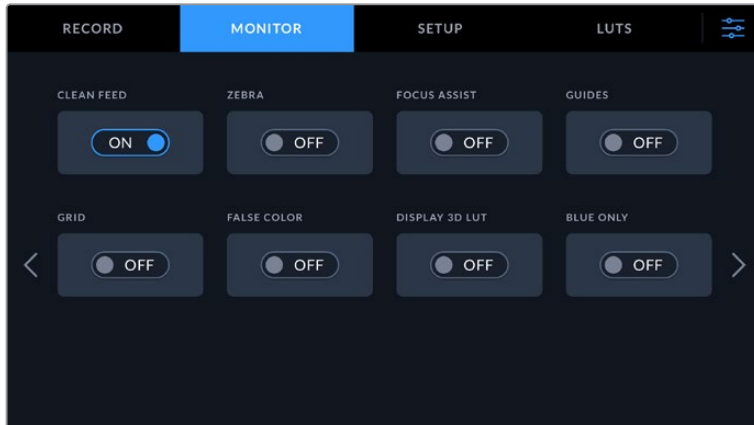

Disable all overlays by selecting clean feed

Zebra

The zebra feature helps you achieve optimum exposure by displaying diagonal lines over areas of the video that exceed your set zebra level. For example, if you set the zebra level to 100%, you'll know that any area of the image displaying the zebra pattern will be clipped. If you set the zebra to 90%, you can feel confident that you have some extra exposure headroom to protect the highlights in your shot.



Zebra controls on Blackmagic Video Assist

TIP You can also set the zebra to highlight areas of your image that represent specific video levels on a waveform, for example setting the zebra for 50% means you can visually identify which regions of your image will appear at approximately 50% on a waveform scope.

Focus Peaking and Focus Assist

Focus peaking and focus assist settings give you powerful tools to help focus your images fast. Focus peaking displays edge lines on the sharpest areas of the image. Sensitivity settings let you change how strong the lines are.

Change the sensitivity settings by tapping the left and right arrows or drag the slider left or right. Sensitivity levels include 'low', 'medium' or 'high'. In images with lots of detail and high contrast, the lines can be distracting, so in these conditions you can select 'low' or 'medium'. Alternatively, for low contrast shots with less detail, select 'high' so the lines are stronger and easier to see.

Edge lines are extremely effective. They can be so pronounced that you can even monitor the depth of your focal plane, plus watch it move closer or further into your shot as you adjust your camera's focus ring. Changing the color of the edge lines can also make them easier to see in conditions where their color may match the image. If you find lines are too visually intrusive, you can select 'peak' levels instead. You can change the color of the lines, or switch to using peak levels via the 'monitor' tab in the menu.

Guides

The frame guides feature provides aspect ratio overlays for various cinema, television and online standards. With guides selected, tap the left or right arrows, or drag the slider icon left or right to select your frame guide.

The following frame guides are supported:

2.40:1, 2.39:1 and 2.35:1

Displays the broad widescreen aspect ratio compatible with anamorphic or flat widescreen cinema presentation. The three widescreen settings differ slightly based on the changing cinema standards over time. 2.39:1 is one of the most prominent standards in use today.

2:1

Displays a ratio slightly wider than 16:9 but not as wide as 2.35:1.

1.85:1

Displays another common flat widescreen cinema aspect ratio. This ratio is slightly wider than HDTV, but not as wide as 2.39:1.

14:9

Displays a 14:9 aspect ratio used by some television broadcasters as a compromise between 16:9 and 4:3 television sets. Ideally, both 16:9 and 4:3 footage remains legible when center cropped to fit 14:9. You can use this as a compositional guide if you know your project may be broadcast by a television station that uses 14:9 cropping.

4:3

Displays the 4:3 aspect ratio compatible with SD television screens, or to help frame shots when using 2x anamorphic adapters.

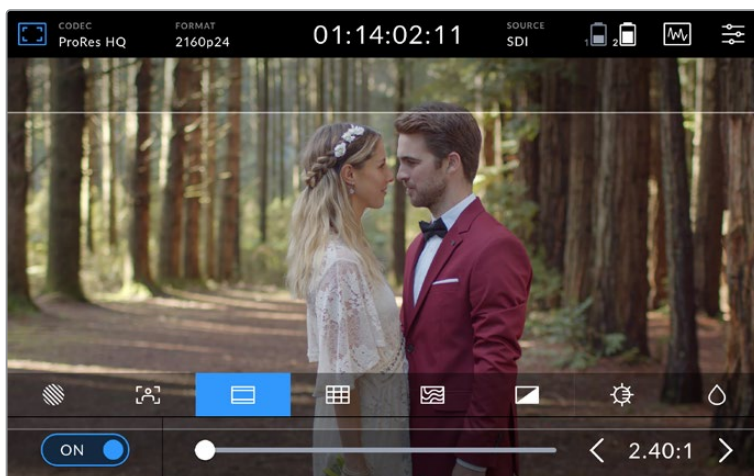

2.40:1 frame guides are useful for framing shots to suit a popular flat widescreen cinema format.

Grids

Your video assist features three types of framing assistance.

Thirds	Thirds are an extremely powerful tool to help compose your shots with two vertical and horizontal lines placed in each third of the image. The human eye typically looks for action near the points where the lines intersect, so it's helpful to frame key points of interest in these zones.
Crosshairs	The 'crosshairs' setting places a crosshair in the center of the frame. Like thirds, the crosshairs is a very useful compositional tool, making it easy to frame the subject of a shot in the very center of a frame.
Center Dot	The 'center dot' setting places a dot in the center of the frame. This works in exactly the same way as the 'crosshair' setting, albeit with a smaller overlay that you may find less intrusive. You can enable a combination of 'thirds' and 'crosshairs' or 'thirds' and 'center dot' by tapping both options in the 'grids' menu. 'Crosshairs' and 'center dot' cannot be selected together.

TIP An actor's eyeline is commonly framed along the top third of the screen, so you can use the top horizontal third to guide your framing. Thirds are also useful to maintain framing consistency between shots.

False Color

The false color feature displays color overlays on your image that represent exposure values. The color values correspond to optimum exposure settings, for example pink for lighter skin tones and green for 38.4% middle grey. False color is also helpful to know when shadows and highlights are near clipping or clipping.

With a range of tonal values on the LCD at once, this gives you a broader overview of your exposure which you can use to refine lighting on set, or make exposure changes to compensate.

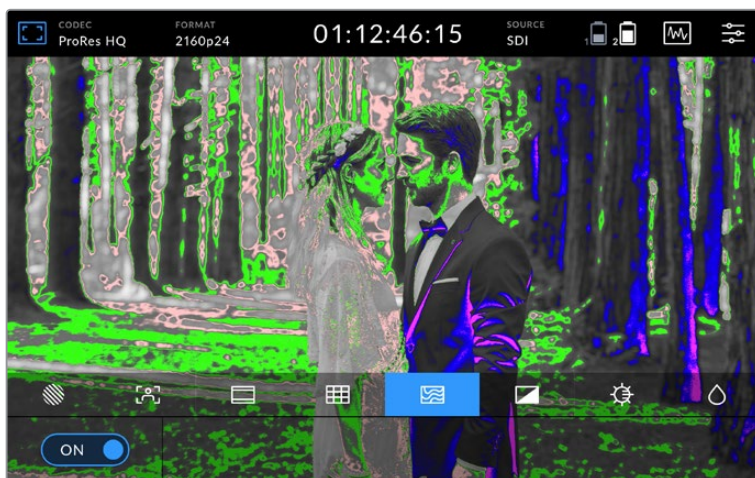

The following chart shows how the colors correspond to specific tonal values.

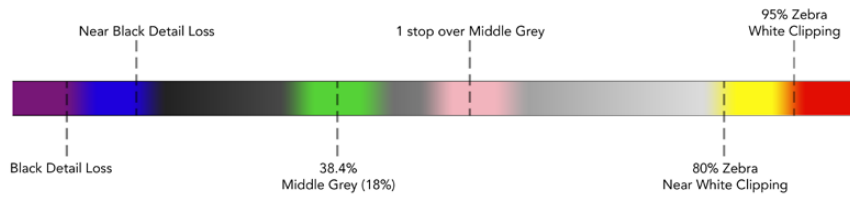

False Color Chart

Your video assist also features controls to adjust the LCD brightness, contrast and saturation. These controls can be accessed via the 'monitor overlay' icon.

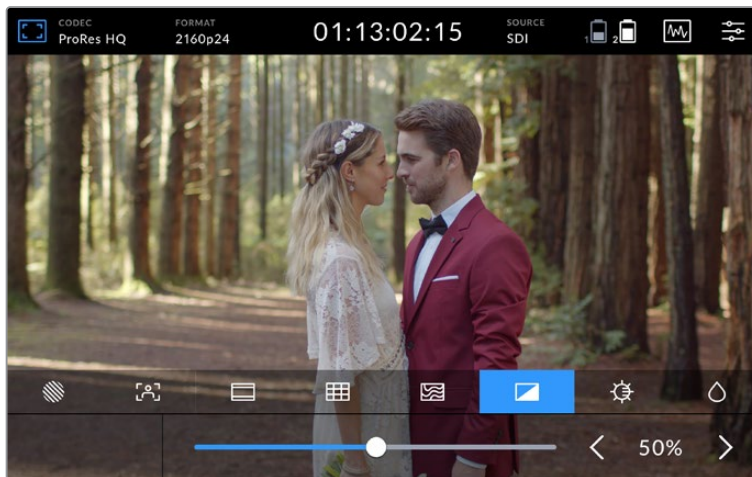

Contrast		Increases or decreases the range between the bright and dark areas of the image. High contrast can reveal detail and depth in the image, and low contrast can make the image appear soft and flat.
Brightness		Adjusts the general brightness of the LCD. For example, if you are outside in bright conditions, increase the LCD brightness to make it easier to view.
Saturation		Move the slider to increase or decrease the amount of color in your displayed image.

All settings will be remembered when the unit is powered off. It's also worth mentioning that any changes to these settings will affect the image displayed on the LCD, but not your recorded video.

Auto Dim

Blackmagic Video Assist 12G HDR can display up to 2,500 nits in brightness. To protect the unit when operating it at high temperatures, the auto dim feature will activate, lowering the brightness of the display. The brightness level will steadily decrease as the video assist operating temperature continues to increase. If the unit temperature decreases, the brightness level will return to the set value.

For example, if your video assist brightness is set to 100% and you are using it in direct sunlight on a hot day, the video assist's temperature will increase.

Once the unit's operating temperature exceeds approximately 46°C, an alert will appear in the upper toolbar's monitor overlay icon.

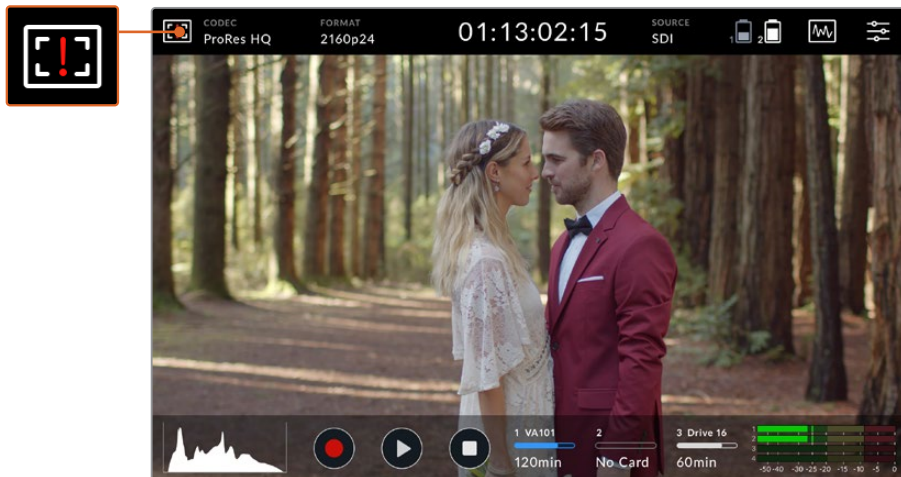

This alert lets you know that you are near the temperature limit for that screen brightness value.

From here you have two options:

Option 1 – Lower the screen brightness manually

Tap on the alert to reveal the brightness slider. The slider control will display the current highest brightness available. Drag the slider to the left to reduce the brightness. The temperature alert will disappear once the unit temperature decreases.



Option 2 – Use the automatic dim feature

Once the temperature reaches the limit, the screen will automatically dim. The auto dim feature will activate to protect your unit from overheating. As the video assist’s temperature increases, the brightness level will steadily decrease. If the unit temperature decreases, the brightness level will increase, eventually returning to the value you set.

Codec

The codec indicator displays the currently selected codec. Tap the codec icon to select which codec and quality you want to use.

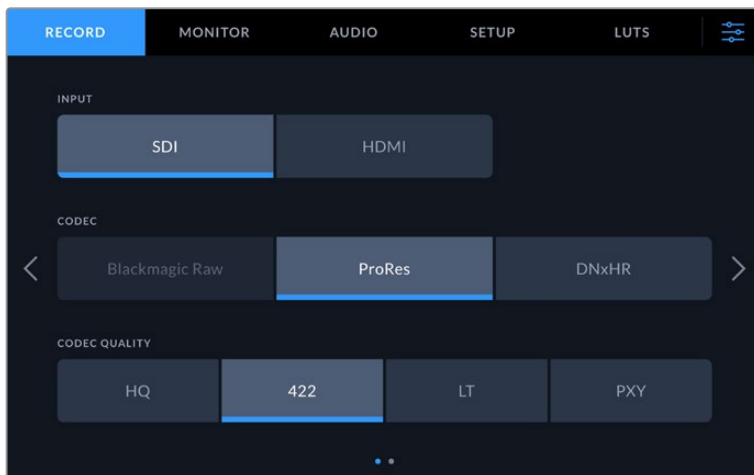

Blackmagic Video Assist 12G HDR codec options

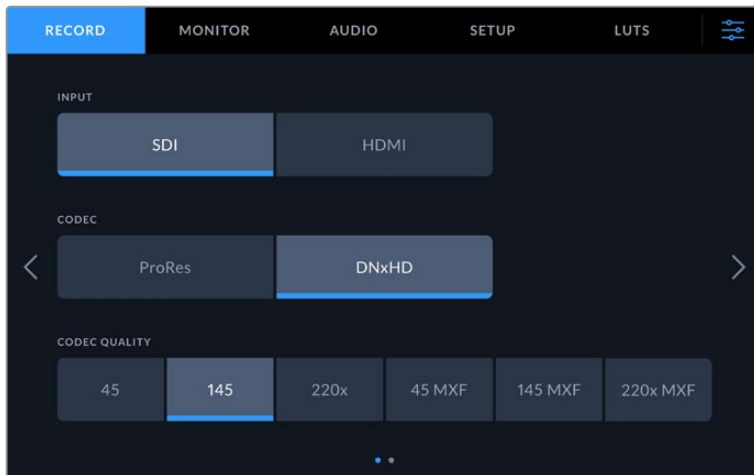

Blackmagic Video Assist 3G codec options

Supported Codecs

ProRes codecs are recorded as QuickTime files. DNxHD and DNxHR files can be recorded as QuickTime or native MXF files where MXF appears in the codec name. Refer to the following table for more details regarding the codec options.

Codecs	Blackmagic Video Assist 3G	Blackmagic Video Assist 12G HDR
	Bit Depth	Bit Depth
ProRes 422 HQ	10	10
ProRes 422	10	10
ProRes 422 LT	10	10
ProRes Proxy	10	10
DNxHD 220x	8	–
DNxHD 145	8	–
DNxHD 45	8	–
DNxHD 220x MXF	8	–
DNxHD 145 MXF	8	–
DNxHD 45 MXF	8	–
DNxHR HQX	–	10
DNxHR SQ	–	8
DNxHR LB	–	8
DNxHR HQX MXF	–	10
DNxHR SQ MXF	–	8
DNxHR LB MXF	–	8
Blackmagic RAW 3:1	–	12
Blackmagic RAW 5:1	–	12

Codecs	Blackmagic Video Assist 3G Bit Depth	Blackmagic Video Assist 12G HDR Bit Depth
Blackmagic RAW 8:1	–	12
Blackmagic RAW 12:1	–	12
Blackmagic RAW Q0	–	12
Blackmagic RAW Q5	–	12

Format

Input video resolution and frame rate is displayed in the ‘format’ section of the upper toolbar. For example, 2160p29.97, 2160p25, 1080p59.94, etc.



The following video input and output formats are supported:

SDI Input and Output	
SD Video Standards	525i59.94 NTSC, 625i50 PAL
HD Video Standards	720p50, 720p59.94, 720p60 1080p23.98, 1080p24, 1080p25, 1080p29.97, 1080p30, 1080p50, 1080p59.94, 1080p60 1080PsF23.98, 1080PsF24, 1080PsF25, 1080PsF29.97, 1080PsF30 1080i50, 1080i59.94, 1080i60
2K Video Standards	Blackmagic Video Assist 12G HDR models: 2Kp23.98 DCI, 2Kp24 DCI, 2Kp25 DCI 2KPsF23.98 DCI, 2KPsF24 DCI, 2KPsF25 DCI
Ultra HD Video Standards	Blackmagic Video Assist 12G HDR models: 2160p23.98, 2160p24, 2160p25, 2160p29.97, 2160p30 2160p50, 2160p59.94, 2160p60
4K Video Standards	Blackmagic Video Assist 12G HDR models: 4Kp23.98 DCI, 4Kp24 DCI, 4Kp25 DCI

HDMI Input and Output	
SD Video Standards	525i59.94 NTSC, 625i50 PAL
HD Video Standards	720p50, 720p59.94, 720p60 1080p23.98, 1080p24, 1080p25, 1080p29.97, 1080p30, 1080p50, 1080p59.94, 1080p60 1080i50, 1080i59.94, 1080i60
Ultra HD Video Standards	Blackmagic Video Assist 12G HDR models: 2160p23.98, 2160p24, 2160p25, 2160p29.97, 2160p30 2160p50, 2160p59.94, 2160p60
4K Video Standards	Blackmagic Video Assist 12G HDR models: 4Kp23.98 DCI, 4Kp24 DCI, 4Kp25 DCI

Timecode

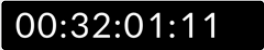
During recording or playback, the timecode view at the top of the display will update to show you the current time of your clip. Select between timeline or clip timecode, or even SMPTE. Simply tap the timecode display to toggle between SMPTE and clip timecode.

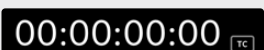
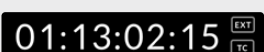
	SMPTE timecode mode is indicated by a 'tc' icon to the right.
	The time counter displays the timeline timecode.
	The timecode display will appear red while the unit is recording in both timecode and time counter modes.
	If your source doesn't have a valid timecode, the timecode for each recording will begin at 00:00:00:00.
	External timecode input is indicated by a 'ext' icon to the right.

Trigger Record

This lets you start and stop recording triggered by information received over the SDI or HDMI connection. Tap on the 'trigger rec' icon on the upper status bar to select your trigger record option. You can turn on trigger recording via the 2nd page of the 'record' tab on the dashboard menu.

None

To disable trigger recording, select 'none' or 'never'.

Video start/stop

This setting will set your video assist to start and stop recording when you press the record start and stop button on your camera.

For SDI/HDMI start/stop trigger recording you will need to use a camera that can trigger the record function via HD-SDI or HDMI.

Cameras which support trigger recording may include menu options such as 'trigger rec', 'HD-SDI remote I/F' or 'SDI remote start/stop trigger'.

Timecode Run

When timecode run is selected, your video assist will start recording as soon as it detects running timecode from your SDI or HDMI source. Recording will stop when the timecode has ceased. This feature is useful when connecting cameras that don't support SDI start/stop trigger recording. You may need to set your camera's timecode setting to 'record run' to make sure timecode only runs while your camera is recording.

If your camera's timecode is set differently, for example time of day timecode, the timecode is always running and will continuously trigger the recording on your video assist.

Blackmagic Video Assist features additional timecode functions via the 'setup' tab of the dashboard menu.

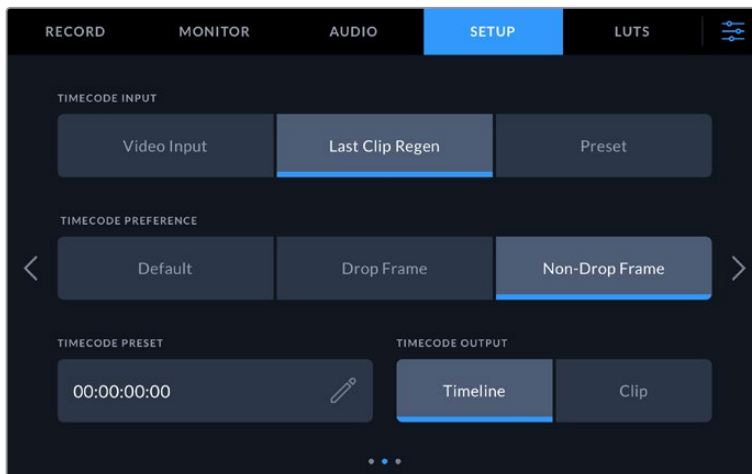

Timecode input options on 5" models

Timecode Input

There are three timecode input options available when recording.

Video Input

Selecting video input will take the embedded timecode from SDI and HDMI sources with embedded SMPTE RP 188 metadata. This will maintain sync between your SDI or HDMI source and the file recorded on your video assist.

External

To use XLR timecode input on 7" video assist models select 'external'.

Last Clip Regen

By selecting 'last clip regen' for your timecode input, each file will start one frame after the last frame of the previous clip. For example, if your first clip ends on 10:28:30:10, the next clip timecode will start at 10:28:30:11.

Preset

Preset uses the timecode entered under the 'timecode preset' option.

Timecode Preference

For NTSC sources at frame rates of 29.97 or 59.94, you can select 'drop frame' or 'non-drop frame' recording. If you are not sure whether your video is drop frame or non-drop frame, tap on default. This will maintain the standard of the input, or default to drop frame if there is no valid timecode.

Timecode Preset

You can set your timecode manually by tapping on the pencil icon and entering the start time code via the touchscreen keypad.

Timecode Output

You can select your timecode output from two options. This also selects your timecode view in the upper toolbar.

Timeline

Tap the timeline option to output your timeline timecode.

Clip

The clip option will output the timecode of your clip.

HDR

Blackmagic Video Assist 12G HDR's ultra bright display is perfect for HDR workflows. The wide color gamut displays 100% of the DCI-P3 color space and brightness controls let you work even outside in bright sunlight.

If you are recording or playing HDR content, 'HDR' will appear to the right of the timecode display. The HDR information will be tagged on the SDI and HDMI output connectors so you can connect an HDR enabled device, such as an HDR television, to view the full gamut on a larger display.

When recording .mov files in Apple ProRes or DNxHR, the HDR information will be included in the metadata of the file.

Source

Displays the selected SDI or HDMI input source. To select your source, tap on the source icon to open the source settings and select SDI or HDMI.

Battery Status

The battery status indicator displays the amount of power remaining in your batteries. Tap the battery icon to open a larger display with more precise information about your battery levels.

TIP When using 12V power instead of batteries, 'AC' will appear in place of the battery icons.



During operation, your video assist will use the battery with the lowest charge first, then swap over to the other when depleted without interruption. The battery icon will turn red once the remaining capacity is lower than 25%.

Video Scopes

Blackmagic Video Assist features a set of four real time video scopes that you can use to monitor the luminance and chroma levels of your video signal. You can choose to display a waveform, parade, vectorscope or histogram. Using these scopes you can monitor your tonal balance and check the levels of your video to avoid crushing your blacks and clipping the highlights, plus monitor any potential color cast in your clips.

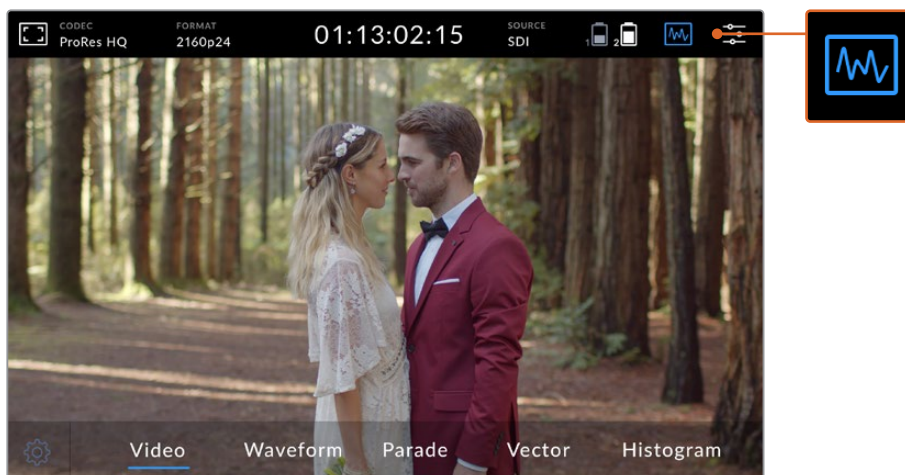

The video scopes menu bar showing the scope display options

Each scope provides an accurate graphical analysis of the various characteristics of the video signal, showing you the relative strength and range of individual video components including luma, chroma, saturation, hue, and the red, green, and blue channels that together, comprise the color and contrast of your video signal.

Enabling the scopes

To access the video scopes, tap the scopes icon or the display histogram, depending on your model. From here, you can choose the scope you want, for example, waveform, parade, vectorscope or histogram. To view the video image without a scope, select 'video'.

Tap the scopes icon to close the menu. You can now access the transport controls and view the audio meters.

Adjusting the scopes

With a scope selected, tap the scope settings icon on the left hand side of the display to open the scope brightness and opacity settings.

Scope Brightness

Adjust the brightness to make fine details in the scope graph more or less defined.

Background Opacity

Adjust the opacity to set the amount of transparency for the scope background.

Making adjustments to both settings lets you find the perfect combination so you can monitor the video and scopes at the same time.

Tapping the 'preview icon' displays the scopes full screen, while displaying the video image in the top right corner. This provides another option to view both scopes and the video image at the same time, but lets you study the scopes in greater detail. You can also move the preview to a different area by dragging it to a new location.



Tapping the preview icon will display the scopes full screen with the video image in the top right corner of the screen

Waveform

The waveform display provides a digitally encoded waveform similar to traditional luminance waveform monitors, which is used to monitor the luma or brightness levels of your video signal.

The bottom of the graph indicates the black level, or shadows, of the image, while the top of the graph indicates the white level, or highlights. The range between the top and bottom of the graph indicates the overall contrast ratio of the image you're evaluating. Depending on your footage, your waveform will look different. If you are monitoring video which is high contrast, you might not see any values in the mid grays.

For perfect video levels without clipping, you will want to make sure the blacks in your waveform do not drop below 0% and the whites do not exceed 100%. If the levels exceed these boundaries, the video image will be clipping and you will see the results as lost detail in the shadows and highlights of your image.

The waveform monitor is a graphical representation of the image, showing luma values corresponding to the same horizontal position within the video image. For example, if filming an outdoor scene where the left side of your sky is overexposed, you will see the left side of the waveform graph above 100%.

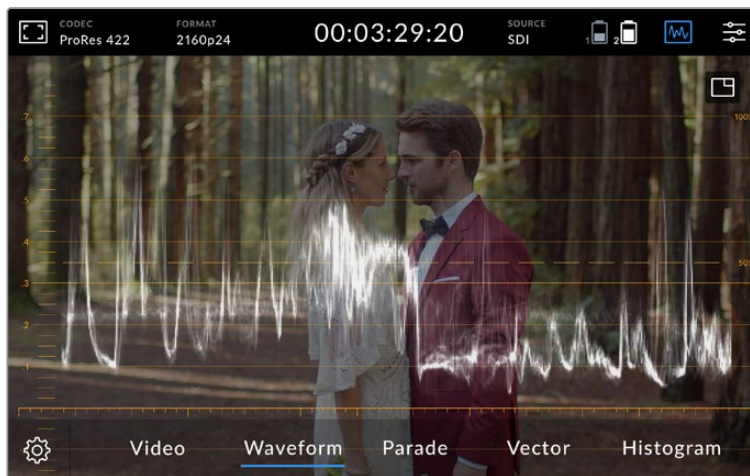

The waveform display showing luminance values

RGB Parade

The RGB parade shows separate waveforms displaying the luminance of each red, green and blue color channel. By showing a comparison of each channel, the parade scope makes it possible to monitor the levels of each channel, plus spot color casts by comparing the highlights, midtones and shadows between each channel. For example, if the shadows are higher in the blue channel, your blacks will have a shade of blue to them.

Having the ability to see how the differences between all the tonal ranges compare within each channel gives you an extremely detailed overview of color in your image. You can immediately spot white balance issues and color casts, and because the parade scope shows a waveform for each channel, you can also see if one specific color channel is clipping, which you may not see if you are looking at a single combined waveform.

The three separate RGB waveforms follow the same principles displayed in the waveform scope, with the top, middle and bottom positions representing the highlights, mid tones and shadows along the horizontal axis of the video image.



The RGB parade displays separate waveforms displaying the luminance of the red, green and blue channels

Vectorscope

The vectorscope measures the overall range of color hue and saturation within an image. Blackmagic Video Assist has a traditional vectorscope, emulating a trace drawn graph, with 100 percent color bar saturation targets positioned at the graticule markers surrounding the graph.

Heavily saturated colors in the frame stretch those parts of the graph closer to the edge, while less saturated colors remain closer to the center of the vectorscope, which represents 0 saturation. By judging how many parts of the vectorscope graph branch out at different angles, you can see how many hues there are in the image, with the specific angle of each part of the graph showing you which hues they are.

Additionally, by judging how well centered the middle of the vectorscope graph is relative to the center of the vectorscope, you can get an idea of whether there is a color imbalance in the image. For example, if the vectorscope graph is off centered, the direction in which it leans lets you know that there is a color cast or tint in your image.

While color balance can be monitored on both the RGB parade display and vectorscope display, color balance issues will often be easier to see in the vectorscope display.

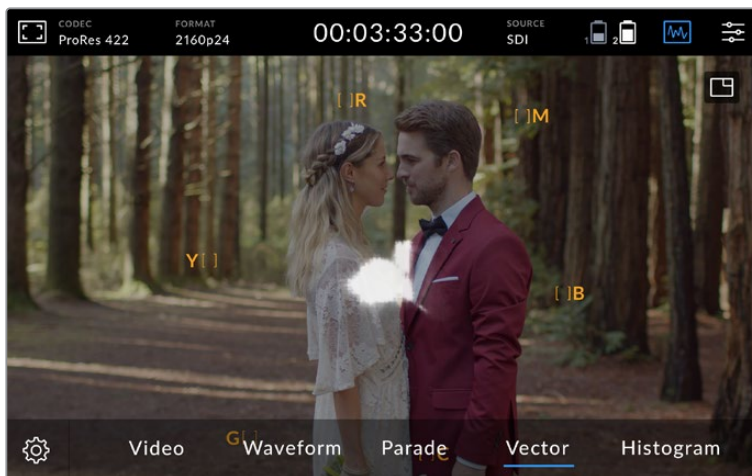

The vectorscope displays the overall range of color hue and saturation within the image

TIP When monitoring a video signal that contains skin tone, you will want to keep your warm color saturation along a line at approximately 10 o'clock on the vectorscope. This is known as the “fleshtone line” and is based on the color of blood beneath the skin’s surface. The fleshtone line is therefore applicable to all skin pigmentations and is the best way to ensure the skin tones look natural.

Zooming into the Vectorscope Graph

The ‘zoom’ feature on the vectorscope display lets you magnify the graph so you can get a closer look at the color information in your image. This is helpful when monitoring images that are desaturated, as they can typically appear as a small cluster of data around the center of the chart.

To zoom into the vectorscope display:

- 1 Double tap the display for 2x magnification.
- 2 Double tap again for 4x magnification.
- 3 Double tap a third time to return to standard viewing size.

Histogram

The histogram shows the distribution of the luminance or the black to white information along a horizontal scale, and lets you monitor how close the detail is to being clipped in the blacks or whites of the video. The histogram also lets you see the effects of gamma changes in the video.

The left edge of the histogram displays shadows, or blacks, and the far right displays highlights, or whites. If monitoring the image from a camera, when you close or open the lens aperture you will notice the information in the histogram moves to the left or right accordingly. You can use this to check ‘clipping’ in your image shadows and highlights, and also for a quick overview of the amount of detail visible in the tonal ranges. For example, a tall and broad range of information around the middle section of the histogram corresponds to good exposure for details in the midtones of your image.

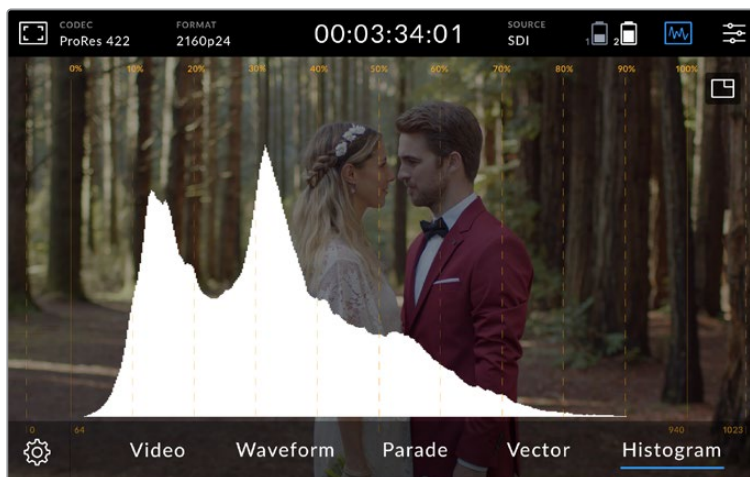

The histogram shows the distribution of the luminance, or the black to white information along a horizontal scale

Your video is likely being clipped if the information bunches to a hard edge at 0% or above 100% along the horizontal scale. Video clipping is undesirable when you are shooting, as detail in the blacks and whites must be preserved if you subsequently want to perform color correction in a controlled environment. When shooting, try to maintain your exposure so information falls off gradually at the edges of the histogram with most forming around the middle. This will give you more freedom later to adjust colors without whites and blacks appearing flat and lacking in detail.

Zoom

The zoom feature lets you zoom into your image so you can carefully check your focus when connected to a camera, or study fine details in your video image. The zoom feature can be used when framing a shot before and during recording and playback.

Simply double tap the screen to zoom in. The zoom window will appear in the upper left hand corner of the display. Touch and drag the screen to view different areas of the image. To return to the normal display, double tap the screen again.

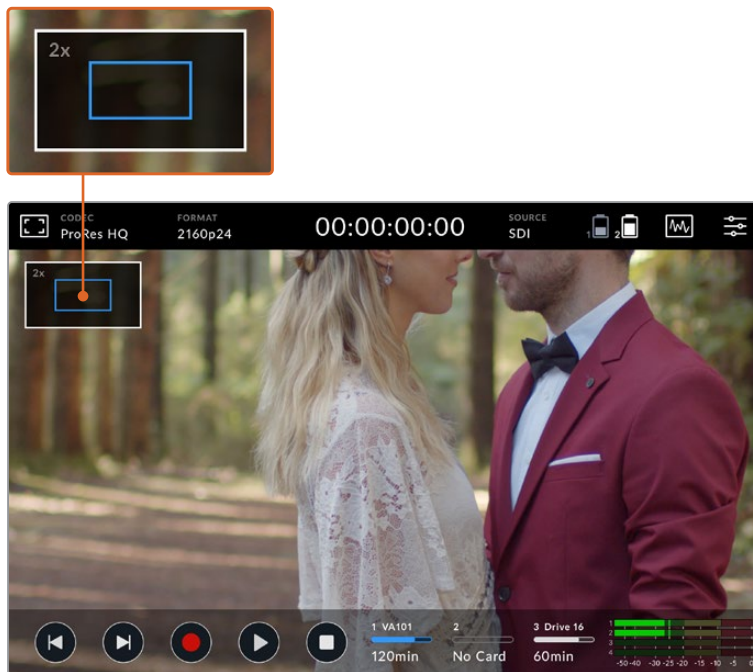

Zoom status indicator on Blackmagic Video Assist

Display Histogram

The left side of the on screen meters displays a histogram showing the distribution of the luminance in your video. Pure black is on the far left side of the display and pure white is on the far right of the display. When the video signal sharpens to a point at the bottom edges within these limits you'll know your shadows and highlights are not clipping, which means details in the tonal ranges of your video are preserved.

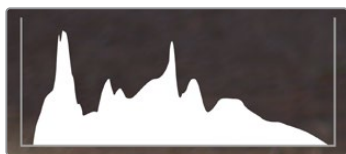

You can toggle the display histogram on or off via the setup tab of the dashboard menu

Storage Indicators

Displays the status of the storage media. Blackmagic Video Assist supports up to 2 SD card slots. 12G models also include an external drive.

To select a card to record to:

- 1 Tap the 'card' status icon to open the storage settings.
- 2 In the storage settings select the card you wish to record to.
- 3 Press 'exit' or the arrow to leave the storage settings page.

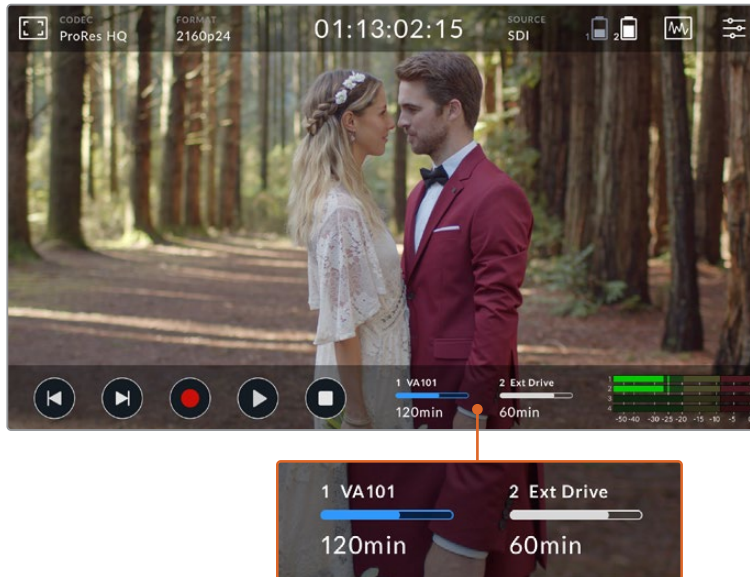

Storage indicator icons on Blackmagic Video Assist 5" 12G HDR display the status of the SD card slot and external drive

Blackmagic Video Assist 12G HDR features a USB-C connection so you can connect a single drive or a Blackmagic MultiDock 10G with up to 4 SSD's.

To select your active drive on Blackmagic Video Assist 12G HDR:

- 1 Tap the 'drive' icon to open the storage settings.
- 2 Tap on 'drive list'.
- 3 Tap the drive you want to select, it will highlight blue. Tap 'use drive'. The active drive is identified by the blue vertical line to the left of the drive icon.
- 4 Tap 'exit' to return to the previous storage settings screen.
- 5 Tap 'exit' again to leave the storage settings screen.

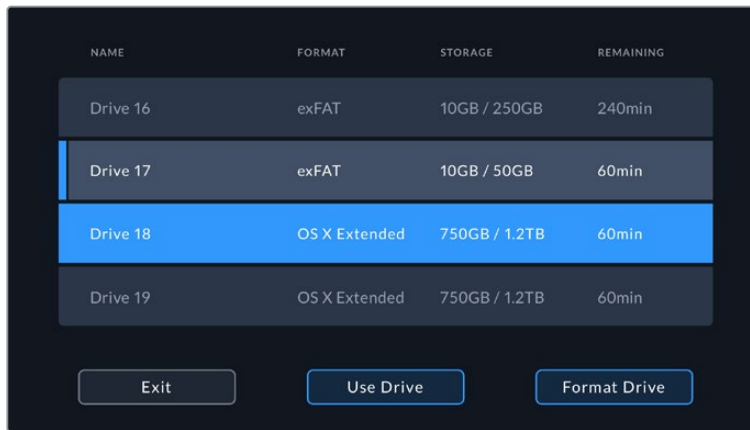

Drive list view on 12G video assist models

It's worth noting that the 'use drive' button will be disabled when the selected drive is already active, or there is only one drive available.

You can also format your storage via the storage settings menu. Refer to the 'formatting storage media using your video assist' section later in this manual for more information.

Storage indicator icons slightly vary between video assist models, and can display the number, name, progress bar and status of the media slots, or just the number and status.

Number



The number indicates the storage slot. For example, Blackmagic Video Assist 12G HDR slot '1' and '2' are the two SD card slots and slot '3' is for the external drive. Slot '2' on the 5" 12G video assist is for any external drive connected via USB-C. You can add the media name in the formatting process.

Name

The name of your storage will display to the right of the slot number so you can make sure you are recording to the right card or drive at all times.

Progress Bar

The bar icon will be either blue, white or red depending on its current status. The intensity of the color will also display the used space on the card.

-  A blue bar indicates the active drive. If you press play, playback will start from this card or drive. If you want to record video, it will be to this card or drive.
-  A white bar indicates there is an SD card or external drive connected, but not active. A solid white icon indicates the drive is full.
-  The bar will be red during recording.

Status

Media status will show either the capacity remaining on the media or the slot status.

Capacity remaining

When your SD card or drive has space remaining, the duration available will be displayed in hours:minutes:seconds based on the current source format and your chosen codec and quality settings. If there is less than an hour left, it will display minutes:seconds remaining only.

When recording, the duration will change to red when there is less than 5 minutes available. Once there is less than 3 minutes of space, the duration will flash from red to white.

If your video assist is not connected to a source, the display will show the remaining space on the SD Card or external drive.

Slot status

'No card' or 'no drive' will display if there is no media connected to that drive slot. Once an SD card or active external drive is full, the icon will display 'card full' or 'drive full' so you know it's time to swap out the storage media. If you have another SD card inserted, the recording will automatically spill over and start recording onto it. If you have an external drive connected, the recording will spill over to the active drive once the second SD card is full.

Audio

Audio Meters

The audio meters in the lower toolbar display up to four audio channels. These can be set to either PPM or VU meters via the setup tab in the dashboard menu. You can also change which channels will appear in the lower two meters. This is available in the 'monitor channels' setting in the audio tab of the dashboard menu. When other channels are selected, the channel number will change in the on screen audio meters.

Speaker and Headphone Level

To adjust the volume for the built in speaker or headphones on your video assist, swipe the LCD up or down to reveal the lower toolbar, then tap the audio meters to open the audio level settings. Simply drag the volume slider to increase or decrease the volume for the speaker or headphone.

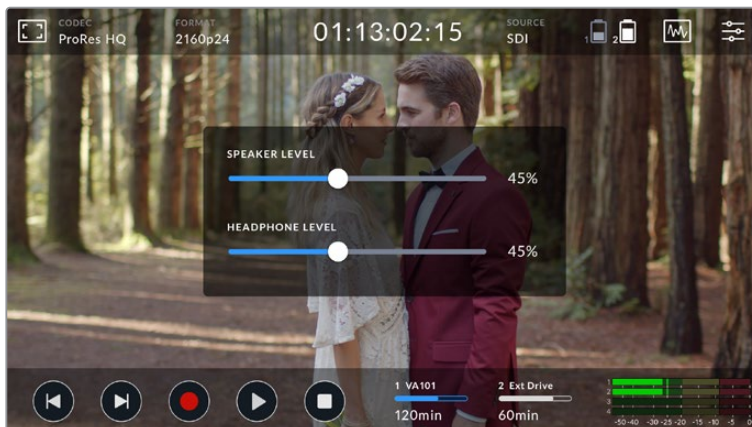

TIP To avoid potential feedback when a microphone is connected, the speaker is enabled during playback, but is disabled while your video assist is recording or monitoring the video input.

In addition to speaker and headphone levels, on 7" video assist models you can also adjust the XLR input levels.

To record optimum audio without clipping, adjust the sliders on each input. Ideally your peak audio levels should fall in the yellow zone. If your peaks enter into the red zone, your audio is in danger of clipping.

To adjust your analog audio levels on 7" video assist models, simply tap the audio meter and then drag the sliders for each channel left or right. You can also adjust your analog audio levels and other audio controls via the 'audio' tab in the dashboard menu.

The 7" video assist models are also powerful audio recorders. Each XLR input has independent settings including:

Recorded Audio Channels

Blackmagic Video Assist can record up to 16 channels of audio at a time. Select how many channels of audio to record from 2 to 16 channels. On some models you can find this setting via the record tab in the dashboard menu.



On 7" video assist models XLR audio levels can be adjusted

Record XLR Inputs To

When you are recording more than two audio channels you can assign which channels will record your XLR inputs. For example, when recording 8 channels of audio, you can record your XLR inputs to channels 7-8 by tapping the arrows. If you are not using XLR audio, simply select the none option.

Audio meters display up to 16 channels of audio. The channels will be enabled or disabled based on how many recorded audio channels are selected.

XLR Line or Mic

When connecting professional audio equipment other than microphones to the analog XLR inputs, make sure you set the recording level to 'XLR line'. Most professional audio equipment outputs 'line' level audio which is a stronger signal compared to 'mic' level. Alternatively, when connecting microphones to the XLR inputs, set the respective input to 'XLR mic' level. This is because microphones typically output a signal that is slightly weaker in strength compared to equipment with line level output, so the signal is boosted slightly by your 7" video assist to

optimize the recording level. To bypass the XLR analog inputs and maintain the embedded SDI or HDMI channels 1 and 2 from your source video, on 12G video assist models you can set to record your xlr inputs to none. On 3G video assist models, select video.

NOTE Your video assist remembers your settings even after power cycling. Make sure you reset your audio settings when changing your connections.

Pad XLR

If you are shooting in a noisy environment or near unpredictably loud sounds, you can set the XLR padding feature to 'on'. This will drop your audio levels down by a small amount and give you slightly more range in levels which may help you prevent clipping. If you are shooting in normal audio conditions, set this feature to 'off'.

Phantom Power

When connecting microphones that are not self powered, you can power them using phantom power via the XLR connector. Simply turn the setting to 'on'.

NOTE Make sure you have phantom power turned 'OFF' when using microphones that are battery powered as some battery powered microphones can be damaged when phantom power is supplied.

Menu Settings

Your video assist also features additional settings available via the tabbed menus.

Record

If Card Drops Frame

Sometimes you may encounter dropped frames when using slower media, such as UHS-I SD cards, to record higher rate formats. Depending on your workflow, you may want recording to stop when dropped frames are encountered. You can do this by selecting 'stop recording'. If you want to continue recording but be alerted if your storage drops a frame, select 'alert'. An exclamation mark will appear in the lower right hand corner of the display.

Apply LUT in File

If you are shooting with the Blackmagic RAW codec and applying a LUT on Video Assist 12G HDR, the selected LUT will be embedded into the Blackmagic RAW file you are recording. This means that the LUT will be saved in the header of the file and can easily be applied to the clip in post production without needing to handle a separate file. When the 'apply LUT in file' switch is set to 'on' in the record menu, this clip will open in Blackmagic RAW Player and DaVinci Resolve with the chosen LUT already applied to it. The LUT can then be easily toggled 'on' or 'off' but will always travel with the Blackmagic RAW file as it is written into the clip itself.

DaVinci Resolve also has an 'Apply LUT' switch in the RAW settings palette for enabling or disabling the 3D LUT in the Blackmagic RAW file. The 'Apply LUT' setting in DaVinci Resolve is the same setting as in the camera. This means that when shooting you can direct the colorist to use the LUT by setting it in the camera, but they can switch it off easily in DaVinci Resolve by setting 'Apply LUT' to 'off'.

Monitor

Display 3D LUT

Tap the settings toggle switch to turn your selected display 3D LUT on or off. The display 3D LUT option will be disabled when no display LUT is selected. For information on how to load a LUT, see the 'LUTs' tab in the dashboard menu later in this manual.

Blue Only

Your video assist features a 'blue only' mode that displays only the blue channel, represented as a black and white image. If there is noise in a digital video signal, it is most visible within the blue channel, so you can easily check for noise by using this feature. The black and white image can also be used for assistance when checking camera focus. To enable 'blue only' mode, select 'on'.

LCD Screen Rotation

If you want to disable the automatic display rotation, simply set this setting to 'none'. Now the display will stay locked to the current position even if you turn it upside down. You can also set the display to flip 180°. This will keep it locked to that position and is helpful when the unit is mounted to a camera rig in an upside down position. To enable the automatic screen rotation, select 'auto'.

Anamorphic De-squeeze

Blackmagic Video Assist features an 'anamorphic de-squeeze' setting. This allows you to correctly display horizontally 'squeezed' images from a camera using an anamorphic lens. The de-squeeze amount required to correct your image will vary, as each anamorphic lens has a different squeeze factor. You can select the de-squeeze amount of '1.33x', '1.66x', '2x' to correspond with the level of squeeze on different anamorphic lenses. Select 'off' to disable the setting.

Setup

The following options are included in the setup tab of the dashboard menu.

Video Assist/Device Name

You can change the name of your video assist by clicking on the pencil icon to the right of the name. This makes it easier to identify in situations where there may be more than one video assist in use.

Date and Time

When these settings are maintained and accurate, useful information is recorded in your clip files to inform you of the date and time each clip was recorded.

To adjust the date and time settings:

- 1 Tap the 'pen' icon to edit the settings.
- 2 Tap the day, month, year or time edit arrows to change a setting.
- 3 Tap 'save' to confirm the change.

Language

Blackmagic Video Assist supports many languages including Chinese, Japanese, German, French, Russian, Italian, Portuguese and Turkish.

To select your language:

- 1 Tap on the 'language' and select your language from the list.
- 2 Select 'update' to return to the setup menu.

Software Version

Displays the current software version.

Tally Light LED

A tally light on the top that illuminates red when your video assist is recording. This is a particularly useful feature when recording with a DSLR that does not provide an option to display a tally light during recording. Toggle the option to turn tally on or off.

LED Brightness

To set the brightness of the tally light LED, tap 'low,' 'medium,' or 'high.'

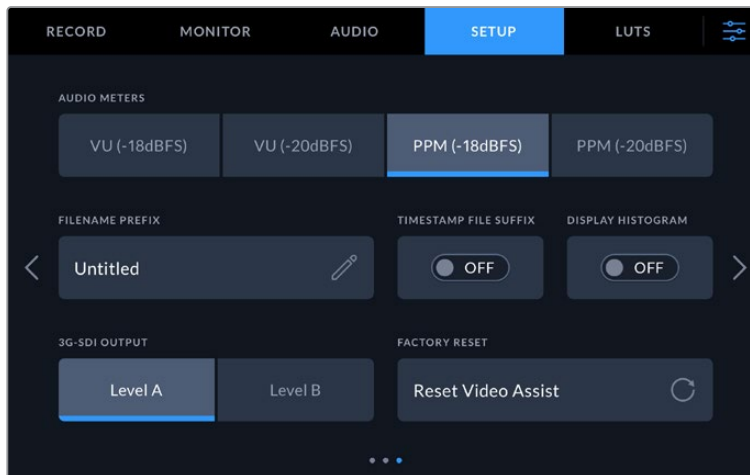

Audio Meters

Blackmagic Video Assist features two different audio meter display types.

VU

The VU meter, or 'volume units' meter, averages out short peaks and troughs in your audio signal. If you are using VU metering, adjust the input levels on the video assist so that the meter peaks at the 0db indicator on the audio meter. This maximizes the signal to noise ratio and ensures your audio is at the highest quality. If your audio peaks beyond the 0dB indicator there is a high risk of sound distortion.

PPM

PPM meters, or 'peak program meters' displays a 'peak hold' feature that momentarily holds the signal peaks and a slow fall back so you can easily see where your audio is peaking.

Both VU and PPM meters are available at reference levels of -18dB or -20dB so you can monitor your audio to suit different international broadcasting standards. To adjust your input levels via the touchscreen, tap on the audio meter in the bottom right corner.

Filename Prefix

Edit the filename of your recorded files by tapping the 'edit' pencil icon. A touchscreen keyboard will appear letting you type in a new name.

Timestamp File Suffix

The timestamp added to the filename is turned off by default. If you would like the date and time recorded in your filename, toggle the 'timestamp file suffix' option to on.

Display Histogram

The histogram display on the lower toolbar will be off by default. If you want to turn the histogram display on, toggle the 'display histogram' switch to on.

3G-SDI Output

Some broadcast equipment can only receive level A or level B 3G-SDI video. To maintain compatibility, tap either 'level A' or 'level B'.

Factory Reset

To reset the video assist to its default factory settings, tap the 'reset' button. After you approve this action on the confirmation page, your video assist erases any stored LUTs and presets, plus resets all settings.

LUTs

Your video assist can display the input video with 3D LUTs applied to the image. A 3D LUT is only used on the display and not actually recorded into the video itself, so you don't need to worry that your recorded image will have the look permanently applied. However, if you want to apply the same LUT to your image in DaVinci Resolve, you can simply import the exact same LUT .cube file used in your video assist into DaVinci Resolve and apply it to your grade.

This gives you powerful options such as matching a look in post that you monitored on set, or conforming to a specific color profile. Refer to the DaVinci Resolve instruction manual for more information on how to use 3D LUTs in your color correction, including exporting LUTs as .cube files so you can import them into your video assist.

To import a 3D LUT:

- 1 Click on the LUTs menu tab.
- 2 Tap the double arrow icon at the bottom of the LUT display.
- 3 From the 'manage lut' option, select 'import LUT'.
- 4 Select the location of your LUT and tap the 'import' icon.
- 5 Select the LUT you wish to import from the list and tap on 'import'. A progress screen will let you know the LUT is importing. Once done, the LUT will appear in the list.

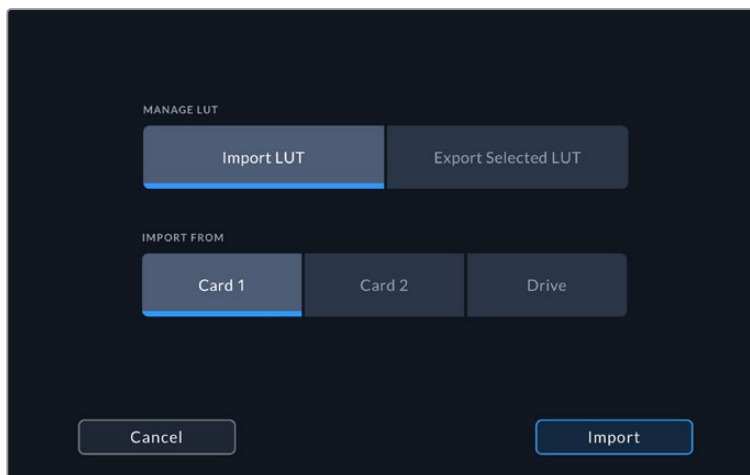

To select your display LUT:

- 1 Tap the 'LUTS' tab on your video assist dashboard menu.
- 2 Select the LUT you wish to use by tapping on it to highlight it blue.

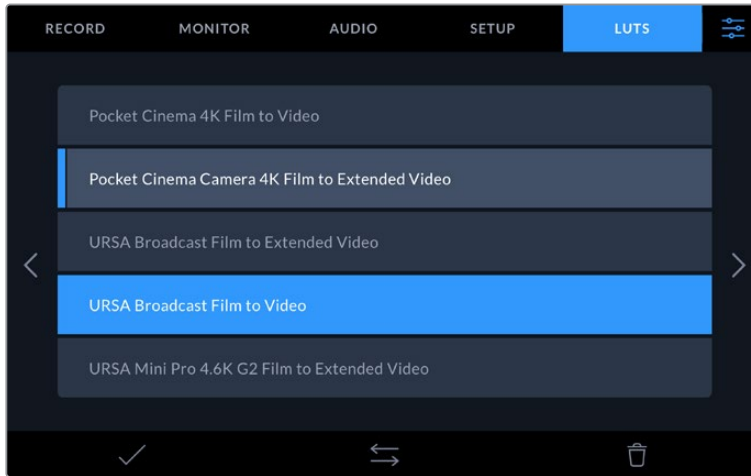

- 3 Tap the tick icon to select the LUT. A blue vertical line will appear on the left of the LUT icon to indicate it is selected.

Entering Metadata

Metadata is information saved inside your clip, such as take numbers, lens information and other identifying details. This is extremely useful when sorting and processing footage in post production. For example, take, shot and scene numbers are essential organizational tools, while lens information can be used to automatically remove distortion or better match VFX assets to plates.

Blackmagic Video Assist automatically saves some metadata to each clip, such as timecode, date and time. You can use the digital slate to add many additional details.

Digital Slate

Swipe from the far left edge on the video assist to reveal the slate. The slate is divided into 'clips', 'project' and 'lens data' tabs. The 'clips' tab contains information that may vary clip by clip, while 'project' is where you enter details common between clips, such as the project name, director, and camera and operator ID. The 'lens data' tab is where you can enter information about the lens in use.

Clips

Making changes to clip metadata works differently in standby mode to playback mode. In standby mode, when your video assist is ready to record, clip metadata gets saved to the next clip recorded, except the 'good take last clip' button applies a 'good take' tag to the most recently recorded clip. In 'playback' mode, when you are reviewing footage already shot, the 'good take' button is shown and clip metadata is always attached to the current clip being viewed.

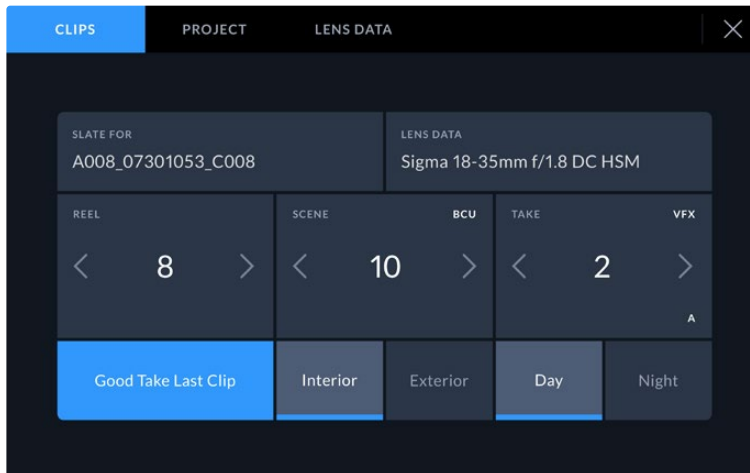

When the video assist is in playback mode, 'slate for' displays the clip the slate applies to and shows the 'good take' button. In standby mode, the slate is for 'next clip' and shows the 'good take last clip' button.

Slate for

This setting shows the clip which the metadata currently displayed in the 'clip' applies to. In 'playback' mode it applies to the current clip. In 'standby' mode it refers to the next clip you record.

Lens Data

The lens data field displays the lens type information. To manually add lens data information, including lens model, focal length and filter, tap on the 'lens data' tab at the top. For information on entering lens data, see the lens data section later in this manual.

Reel

Displays the current reel. Adjust the reel number manually by tapping the arrow right. When you are moving to a new project and want to start from reel '1' again, tap the arrow on the left until you reach '1'.

Scene

The 'scene' indicator shows the current scene number, and can also show the current shot number and type. The number on this indicator always refers to the current scene. You can adjust it with the left and right arrows on either side of the scene number, or tap the scene number to enter the scene number editor.

Scene numbers range from 1 to 999.

By adding a letter to the scene number in the scene number editor, you can also indicate the current shot. For example 23A indicates scene twenty three, shot one. If you have a shot letter added to your scene number, your camera suggests the next scene number and shot letter whenever you enter the scene number editor. For example, if your current scene number is 7B, the camera suggests '8' and '7C'.

The scene number indicator can also show information about the current shot type in the top right corner. You can select these in the scene number editor at the right hand side of the shot keyboard.

The shot types available are:

WS	wide shot
MS	medium shot
MCU	medium close up
CU	close up
BCU	big close up
ECU	extreme close up

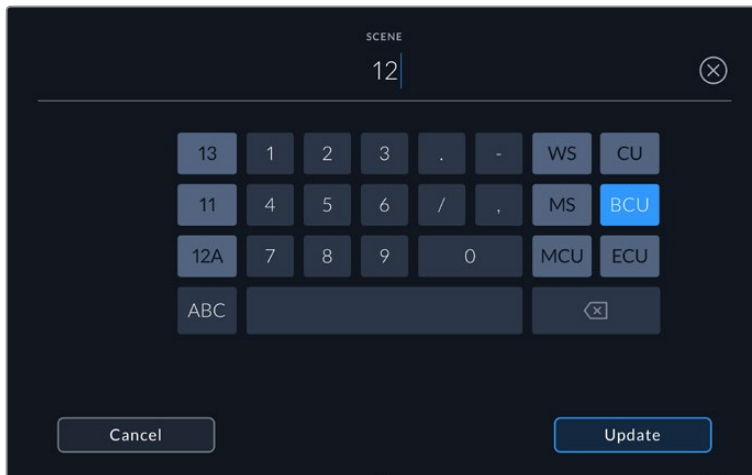

When entering 'scene' metadata, the video assist prompts you with scene number suggestions to the left of the touch keyboard, and shot types to the right

Take

The 'take' indicator shows the take number for the current shot. You can adjust it by tapping the left or right arrows on either side of the take number, or tapping the indicator to enter the take number editor.

TIP When the shot number or scene letter advance the take number reverts to '1.'

You can add descriptions in the take number editor. These are on the right of the take number keyboard and correspond to the following scenarios:

PU	'Pick up.' This refers to a reshoot of a previous take to add additional material after principal photography has wrapped.
VFX	'Visual effects.' This refers to a take or shot for visual effect use.
SER	'Series.' This refers to a situation in which multiple takes are shot while the camera is kept running.

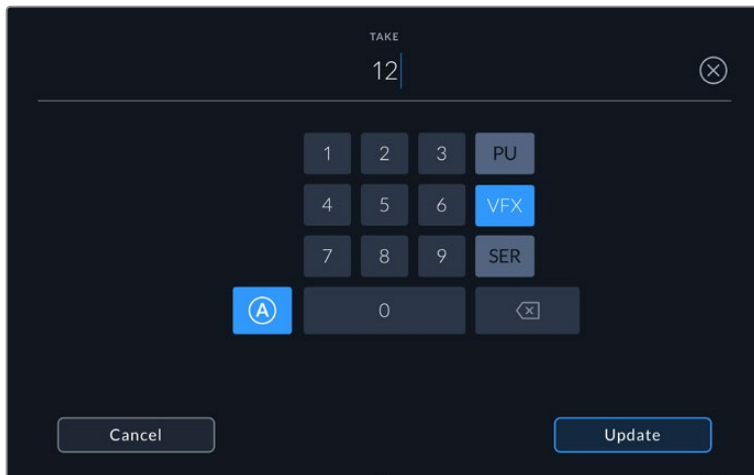

Tap 'A' to enable 'auto take increment' when in 'standby' mode. This will automatically advance the take number for each clip recorded. A small 'A' appears next to the take number on the slate when enabled. When entering 'take' metadata, prompts for additional shot types will appear to the right of the touch keyboard

Good take

Tap the 'good take' indicator to tag good takes for easy recall in post production. This button applies the 'good take' tag to the clip currently being viewed in 'playback' mode. If the camera is in 'standby' mode and ready to record, the 'good take last clip' button applies a 'good take' tag to the last clip recorded.

Interior / Exterior

Tap 'interior' or 'exterior' to add a tag to the next clip in standby mode, or the current clip in playback mode.

Day / Night

Tap the 'day' or 'night' icons to add a 'day' or 'night' tag to the next clip in standby mode, or the current clip in playback mode.

Project

Project metadata behaves the same way whether you are in 'standby' or 'playback' mode. This metadata always refers to your project as a whole and is independent of clip numbers.

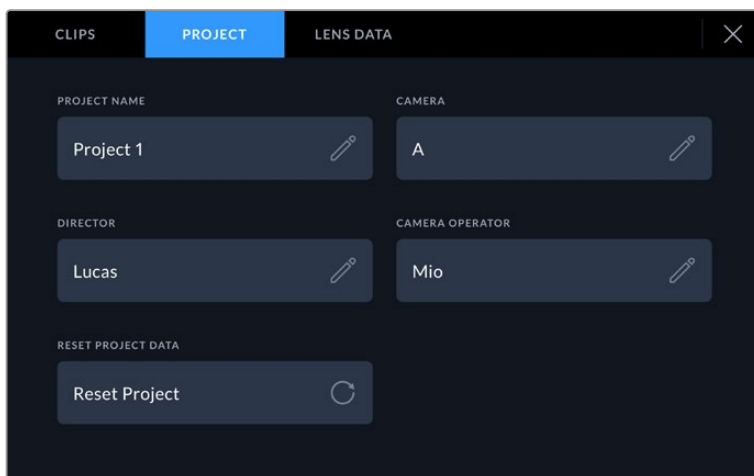

Enter project details using your camera's 'project' slate tab

Project name

Displays your current project name. Tap the pencil icon to change the project name.

Director

Displays the director's name for the current project. Tap the pencil icon to change the director name.

Camera

Displays a single letter camera index. Tap the pencil icon to change the camera index.

Camera Operator

Displays the camera operator. Tap the pencil icon to change the camera operator name.

Lens Data

The 'lens data' menu contains the following information:

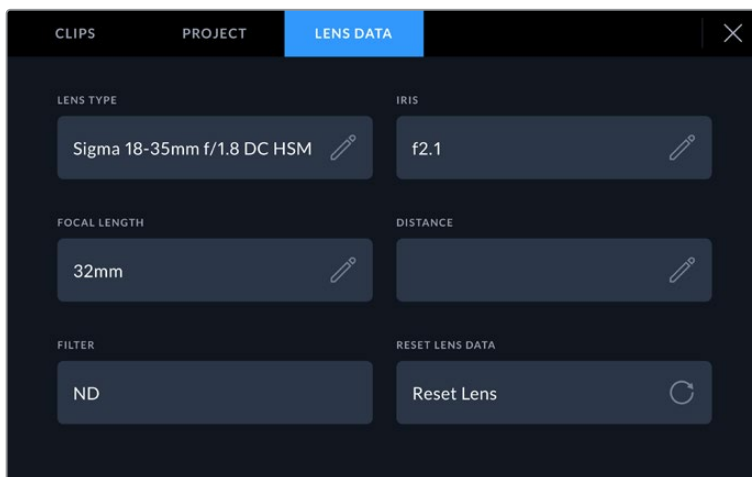

The 'lens data' menu showing information that has been manually entered

Lens Type

Shows the lens model. Tap this setting to enter the data manually. The video assist has an internal database stored for many commonly used lenses, so it will suggest names automatically as you type. This makes entering data much faster.

Iris

Shows the iris aperture setting at the start of your clip. This information can be displayed in f- or T-stops depending on the lens used. Tap this setting to enter data.

Focal length

Shows the focal length setting of the lens at the start of the recorded clip and is shown in millimeters. Tap this setting to enter the focal length manually.

Distance

Shows the focus distance settings of the lens for the recorded clip in millimeters. Tap to enter this data manually.

Filter

Shows the current lens filters used. Tap this setting to enter data manually. You can make multiple entries separated by commas.

NOTE You can clear lens data at any time by tapping the 'reset lens data' icon in the 'lens data' menu. If you have manually entered any information into these fields, you will need to reset the lens data the next time you mount a lens, otherwise the manually entered value will remain.

Recording Blackmagic RAW on Video Assist 12G HDR

With 12G video assist models you can record Blackmagic RAW from Canon C300 II, Panasonic EVA1, Panasonic S1H, SIGMA fp, Nikon Z6, Nikon Z6 II, Nikon Z7 and Nikon Z7 II directly to your video assist. All you need to do is output a RAW signal via your camera's SDI or HDMI out connection.

Connecting your camera to Video Assist 12G HDR

- 1 Connect your camera's SDI or HDMI out to the SDI or HDMI in on your 12G video assist. On Canon C300 Mark II, you can use either the 'rec out' SDI or 'mon' SDI ports. On Panasonic EVA1, use the 'SDI out' port and on Panasonic S1H, SIGMA fp and Nikon cameras use HDMI out.
- 2 On the video assist, set the codec to Blackmagic RAW and select the quality option you want to record. For detailed information on the Blackmagic RAW codec options available, see 'Recording to Blackmagic RAW' later in this manual. Now you can set your camera to output a RAW signal via the SDI or HDMI output.

It's worth noting that Panasonic EVA1 requires the use of a 6G-SDI compatible cable. For Canon C300 Mark II, a 3G-SDI cable is fine.

Canon C300 Mark II

- 1 Click on the 'menu' button on the monitor unit to open the menu on the monitor.
- 2 Using the joystick or touchscreen menu if available, navigate to the 'recording/media setup' submenu and select the 'rec out 4K RAW mode' option.
- 3 Select the '4K RAW' option, this is the only RAW output over SDI option on the Canon C300 Mark II.
- 4 Wait for the display to reboot and return to the menu.
- 5 Now select your color space by using the joystick or touchscreen to select '4K RAW color space'.
- 6 Select either 'BT. 2020 gamut' or 'cinema gamut'. It's worth noting that these are 'baked in' to the raw output, so selecting 'cinema gamut' will offer more latitude in post production.
- 7 Press the 'menu' twice to return to the monitor view.

TIP To make sure the RAW output is compatible with Blackmagic RAW, the gamma must be set to Canon Log 2. For more information on setting your gamut and gamma settings, refer to the Canon C300 Mark II instruction manual available on the Canon website.

Panasonic EVA1

- 1 Press the 'menu' button on the side of the camera to reveal the menu in the viewfinder.
- 2 Using the touchscreen or menu jog/dial wheel, select 'system settings' followed by 'system mode'.
- 3 From the 'SDI RAW' option, select either S35 5.7K for native resolution, crop 4K or crop and mix 2K.
- 4 Press the 'menu' button to return to the previous menu.

When an 'SDI RAW' option is selected, the option to record internally is disabled. It's worth noting that the SDI out option will be disabled when incompatible frame rates are selected, such as 50i and 59.94i. For more information on frame rates and which SDI RAW option is best for you, refer to the operating instructions available from the Panasonic website.

Panasonic S1H

- 1 With the mode dial on the top of the camera set to creative video mode, press the 'menu' button on the side of the camera monitor to reveal the menu.
- 2 Using the joystick or control dial, select 'image format' followed by 'HDMI RAW data output' and select 'on'.
- 3 An alert window will appear to let you know you know no internal recording will take place while the camera is outputting RAW via HDMI. Select 'yes' to proceed.
- 4 In the image format menu, select the 'time code' option and then set 'HDMI time code output' to 'on'. Now time code will pass through to the Blackmagic Video Assist 12G HDR.
- 5 Press the 'back' button and select 'record quality' to select your resolution.

SIGMA fp

- 1 Make sure the camera is in cine mode by selecting the 'cine' switch on top of the camera.
- 2 Press the 'menu' button on the rear to open the menu.
- 3 Using the front dial, navigate to the 'system' sub menu and from the 'HDMI output' option, select 'recorded image output'.
- 4 In the 'output format' sub menu, select 'RAW'.

With RAW selected you can now choose your resolution and frame rate from the options. If you plan on editing Blackmagic RAW together with files recorded internally, make sure you turn the color mode setting off. This can be found in the shoot menu under 'color mode' or by pressing the 'color' button on the rear. Automatically disabled when using the HDMI output for external recorders, turning this off will prevent any color effects such as saturation or tonal changes being embedded in your SIGMA fp files or displaying on the camera's LCD. Now both files will look similar when brought into DaVinci Resolve. For more information on available frame rates, resolutions and color mode, refer to the manual available from the SIGMA website.

TIP If you cannot see a video signal on your video assist when a Blackmagic RAW codec is selected, switch the codec on the video assist to ProRes. If the video signal now appears, it means your camera is not outputting a RAW signal correctly, or the color gamut is incorrect.

Nikon Z6, Nikon Z6 II, Nikon Z7 and Nikon Z7 II

- 1 Press the 'menu' button on the back of the camera.
- 2 Using the multi selector go to the 'Setup Menu', then navigate to 'HDMI' and choose 'Advanced'.
- 3 In the 'Advanced' menu go to 'RAW output options', select 'RAW output' and set to 'Enable (no recording to card)'. When the 'RAW output' option is enabled, the camera will no longer record to its internal media.
- 4 Navigate to 'RAW output mode' and choose a resolution from the list of options.
- 5 Go to 'RAW output type' and set to 'Type B'.
- 6 Press the 'menu' button repeatedly to return to the main screen.

For more information on your camera's RAW output, including supported frame rates and color gamuts, refer to your camera's user manual available via the Canon, Panasonic, SIGMA or Nikon support sites.

Blackmagic RAW

Blackmagic Video Assist 12G HDR supports Blackmagic RAW recording from cameras such as Canon C300 Mark II, Panasonic EVA1, SIGMA fp and Nikon Z7. Preserving the quality of sensor data from the cameras, this format offers superior image quality, wide dynamic range and a broad selection of compression ratios. Blackmagic RAW features all the user benefits of RAW recording, but the files are very fast because much of the processing is performed in the video assist.

Blackmagic RAW also includes powerful metadata support so the software reading the files knows your camera settings. If you like shooting in video gamma because you need to turn around edits quickly and you don't have time for color correction, then this metadata feature means you can select video gamma, shoot in video gamma, and the file will display with video gamma applied when you open it in software. However underneath, the file is actually film gamma and the metadata in the file is what's telling the software to apply the video gamma.

So what all this means is if you want to color grade your images at some point, then you have all that film dynamic range preserved in the file. You don't have your images hard clipped in the whites or the blacks, so you retain detail and you can color grade to make all your images look cinematic. However, if you don't have time for color grading, that's fine because your images will have the video gamma applied and look like normal video camera images. You are not locked in on the shoot and you can change your mind later during post production.

Blackmagic RAW files are extremely fast and the codec is optimized for your computer's CPU and GPU. This means it has fast smooth playback and eliminates the need for hardware decoder boards, which is important for laptop use. Software that reads Blackmagic RAW also gets the advantage of processing via Apple Metal, Nvidia CUDA and OpenCL.

This means that Blackmagic RAW plays back at normal speed like a video file on most computers, without needing to cache it first or lower the resolution.

It's also worth mentioning that lens information is recorded in the metadata on a frame by frame basis. For example, when using compatible lenses, any zoom or focus changes performed over the length of a clip will be saved, frame by frame, to the metadata in the Blackmagic RAW file.

Recording to Blackmagic RAW

Blackmagic RAW works in 2 different ways. You have a choice to use either the constant bitrate codec, or the constant quality codec.

The constant bitrate codec works in a similar way to most codecs. It tries to keep the data rate at a consistent level and won't let the data rate go too high. This means even if you are shooting a complex image that might need a bit more data to store the image, a constant bitrate codec will just compress the image harder to make sure the images fit within the space allocated.

This can be fine for video codecs, however when shooting Blackmagic RAW you really want to ensure the quality is predictable. What would happen if the images you were shooting needed more data, but the codec just compresses harder to make a specified data rate? It's possible you could lose quality, but not be sure it's happening until you return from a shoot.

To solve this problem, Blackmagic RAW also has an alternative codec choice called constant quality. This codec is technically called a variable bitrate codec, but what it's really doing is allowing the size of the file to grow if your images need extra data. There is no upper limit on the file size if you need to encode an image but maintain quality.

So Blackmagic RAW set to the constant quality setting will just let the file grow as big as it needs to be to encode your images. It also means the files could be larger or smaller depending on what you are shooting. I guess if you leave your lens cap on the lens, you won't waste space on your media!

It is also worth noting that the quality settings for Blackmagic RAW are not obscure names, but are more meaningful as they are derived from what's happening technically. So for example when you have selected the constant bitrate codec, you will see quality settings of 3:1, 5:1, 8:1 and 12:1. These are the ratios of the uncompressed RAW file size vs the file sizes you should expect when shooting in Blackmagic RAW. 3:1 is better quality as the file is larger, while 12:1 is the smallest file size with the lowest quality. Many users of Blackmagic RAW find that 12:1 has been perfectly ok and they have not seen any quality limitations. However it's best to experiment and try various settings for yourself.

When using Blackmagic RAW in constant quality you will see the settings are Q0 and Q5. These are the compression parameters passed to the codec and they are setting how much compression is applied in a more technical way. This setting is different because the codec operates differently between constant bitrate vs constant quality. In this constant quality setting, you really cannot tell what the file size ratio will become as it varies a lot based on what you are shooting. So in this case the setting is different and the file will become the size needed to store your media.

Constant Bitrate Settings

The names for 3:1, 5:1, 8:1 and 12:1 represent the compression ratio. For example, 12:1 compression produces a file size roughly 12 times smaller than uncompressed RAW.

Constant Quality Settings

Q0 and Q5 refer to different levels of quantization. Q5 has a greater level of quantization but offers a greatly improved data rate. As mentioned above, the constant quality setting can result in files that grow and shrink quite a lot, depending on what you are shooting. This also means it's possible to shoot something and see the file size increase to beyond what your media card can keep up with. It could result in dropped frames. However the benefit is that you can instantly see if this happens on a shoot and then investigate your settings vs quality.

Blackmagic RAW Player

The Blackmagic RAW player included in your Blackmagic camera's software installer is a streamlined application for reviewing clips. Simply double click on a Blackmagic RAW file to open it, and you can quickly play and scroll through the file with its full resolution and bit depth.

When decoding frames, the CPU acceleration in the SDK library supports all main architectures, and also supports GPU acceleration via Apple Metal, Nvidia CUDA and OpenCL. It also works with the Blackmagic eGPU for extra performance. Blackmagic RAW player is available for Mac, Windows and Linux.

Sidecar Files

Blackmagic RAW sidecar files let you override metadata in a file without overwriting embedded metadata in the original file. This metadata includes the Blackmagic RAW settings as well as information on iris, focus, focal length, white balance, tint, color space, project name, take number and more. Metadata is encoded frame by frame over the duration of the clip, which is important for lens data if the lens is adjusted during a shot. You can add or edit metadata in sidecar files with DaVinci Resolve or even a text editor because it's a human readable format.

Sidecar files can be used to automatically add new Blackmagic RAW settings to a playback simply by moving the sidecar file into the same folder as the corresponding Blackmagic RAW file. If you move the sidecar file out of the folder and reopen the Blackmagic RAW file, the changed settings are not applied and you see the file as it was originally shot. Any software that uses the Blackmagic RAW SDK can access these settings. Changes made are saved in the sidecar file and can then be seen by Blackmagic RAW Player or any other software capable of reading Blackmagic RAW files.

When shooting video gamma, the file stays in film gamma, and the metadata tells the Blackmagic RAW processing to display using video gamma. Video gamma is great when you don't want to grade the image and want to deliver content quickly, however if you want to pull up the black parts of the image, or pull down the white areas, all the detail is retained. You never clip the video and all the detail is still there if you want to access it at any time.

Blackmagic RAW in DaVinci Resolve

Settings can be adjusted for each Blackmagic RAW file, and then saved as a new sidecar file from the 'Camera RAW' tab in DaVinci Resolve for creative effect or optimized viewing. This also means you can copy your media for another DaVinci Resolve artist and they will have access to your modified gamma settings automatically on import.

For more information on how to use Blackmagic RAW in DaVinci Resolve, see the 'Using DaVinci Resolve' chapter in this manual.

Blackmagic RAW Software Development Kit

The Blackmagic RAW Software Development Kit is an API developed by Blackmagic Design. You can use the Blackmagic RAW SDK to write your own applications to use the Blackmagic RAW format. This SDK library can be used by any developer to add support for reading, editing, and saving Blackmagic RAW files. The Blackmagic RAW SDK includes all the generation 4 color science so you can achieve organic cinematic images across any app that supports it. The Blackmagic RAW SDK supports Mac, Windows and Linux, and is available as a free download from the developer page of the Blackmagic website at www.blackmagicdesign.com/developer

The following diagram illustrates the components of the Blackmagic RAW API:

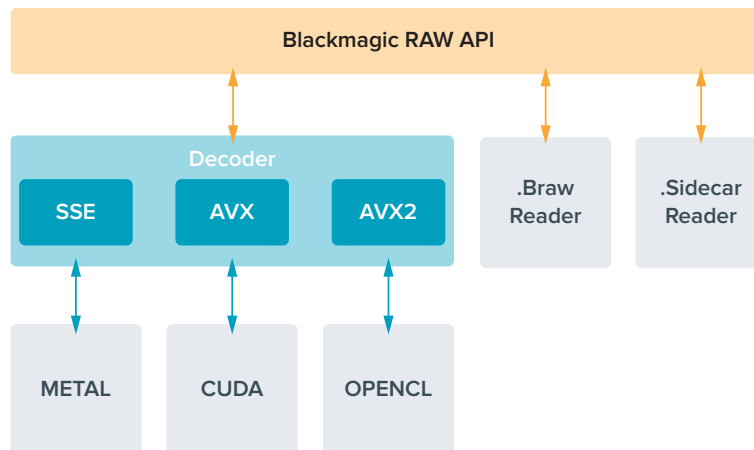

Storage Media

Choosing a Fast SD Card

Generally, we recommend using UHS-II cards for recording UltraHD, and UHS-I for recording HD.

For Ultra HD recording on Blackmagic Video Assist 12G HDR, you will need to use the fastest UHS-II cards available.

Most UHS-I and UHS-II SD cards should be fast enough to record compressed HD video up to 60 frames per second, however it's worth testing your card's record speed to be sure. You can do this using Blackmagic Disk Speed Test software which can be downloaded from the Blackmagic Design support center. For information on using Disk Speed Test, refer to the 'checking disk speed' section of the manual.

We have included a table below that shows the latest compatible SD cards for recording Ultra HD, HD and SD video. It's worth regularly checking the latest version of this manual for more up to date information and can always be downloaded from the Blackmagic Design website at www.blackmagicdesign.com/support

Which SD cards should I use with Blackmagic Video Assist 12G?

The following SD cards are recommended for Ultra HD using Apple ProRes and Avid DNx codecs up to 60 frames per second:

Brand	Card Name	Storage
Angelbird	AV PRO SD V90	64GB
Angelbird	AV PRO SD V90	128GB
Angelbird	AV PRO SD V90	256GB
Delkin Devices	Power UHS-II SDXC	64GB
Delkin Devices	Power UHS-II SDXC	128GB
ProGrade Digital	SDXC UHS-II V90 300R	64GB

Brand	Card Name	Storage
ProGrade Digital	SDXC UHS-II V90 300R	128GB
ProGrade Digital	SDXC UHS-II V90 300R	256GB
ProGrade Digital	V60 UHS-II 200MB/s SDXC	64GB
ProGrade Digital	V90 UHS-II 250MB/s SDXC	128GB
Sony	Tough SF-G128T	128GB
Wise	SD2-64U3 UHS-II SDXC	64GB
Wise	SD2-128U3 UHS-II SDXC	128GB

The following SD cards are recommended for HD using Apple ProRes and Avid DNx codecs up to 60 frames per second:

Brand	Card Name	Storage
Angelbird	AV PRO SD V60	64GB
Angelbird	AV PRO SD V60	128GB
Angelbird	AV PRO SD V60	256GB
Delkin Devices	Black Rugged UHS-I SDXC	128GB
Delkin Devices	Black Rugged UHS-I SDXC	256GB
Kingston	Canvas Go! Plus UHS-I SDXC	64GB
Kingston	Canvas Go! Plus UHS-I SDXC	128GB
Kingston	Canvas Go! Plus UHS-I SDXC	256GB
Kingston	Canvas Go! Plus UHS-I SDXC	512GB
Lexar	Professional 1000x UHS-II 150MB/s SDXC	128GB
ProGrade Digital	SDXC UHS-II V60 250R	64GB
ProGrade Digital	SDXC UHS-II V60 250R	128GB
ProGrade Digital	SDXC UHS-II V60 250R	256GB
SanDisk	Extreme PRO UHS-I 95MB/s SDXC	64GB
SanDisk	Extreme PRO UHS-I 170MB/s SDXC	1TB
SanDisk	Ultra UHS-I 100MB/s SDXC	256GB

The following SD cards are recommended for HD ProRes HQ up to 60 frames per second:

Brand	Card Name	Storage
Lexar	SDHC UHS-II 1000x 150MB/s	32GB
Lexar	SDXC UHS-II 1000x 150MB/s	64GB
Lexar	SDXC UHS-II 1000x 150MB/s	128GB
Lexar	SDXC UHS-II 1000x 150MB/s	256GB

The following SD cards are recommended for HD using Apple ProRes and Avid DNx codecs up to 30 frames per second:

Brand	Card Name	Storage
Lexar	SDHC UHS-I 633x 95MB/s	32GB
Lexar	SDXC UHS-I 633x 95MB/s	64GB

Choosing a USB-C Flash Disk

Blackmagic Video Assist 12G HDR features a high speed USB-C expansion port, which allows you to record video directly to USB-C flash disks or SSD's via Blackmagic MultiDock 10G and also to perform software updates. USB-C flash disks are fast, high capacity drives allow you to record video for long periods, which can be important when filming events or interviews.

Once you have finished recording you can connect the same drive directly to your computer for editing and post production, without having to copy media across.

To connect to a USB-C flash disk:

- 1 Connect one end of a USB type-C cable to your USB-C flash disk.
- 2 Connect the other end of the cable to the USB-C port on the base of your 12G video assist.

Which disk should I use with Blackmagic Video Assist 12G?

The following USB-C drives are recommended for Ultra HD using Apple ProRes and Avid DNx codecs up to 60 frames per second:

Brand	Card Name	Storage
Angelbird	SSD2GO PKT	1TB
Samsung	Portable SSD T5	1TB
SanDisk	Extreme Portable SSD	1TB
Wise	PTS-256 Portable SSD	256GB
Wise	PTS-512 Portable SSD	512GB
Wise	PTS-1024 Portable SSD	1TB
Wise	PTS-2048 Portable SSD	2TB

The following USB-C drives are recommended for HD using Apple ProRes and Avid DNx codecs up to 60 frames per second:

Brand	Card Name	Storage
Angelbird	SSD2GO PKT	1TB
Delkin Devices	DJUGBM1TB	1TB
Samsung	Portable SSD T5	1TB
SanDisk	Extreme Portable SSD	1TB
Wise	PTS-256 Portable SSD	256GB
Wise	PTS-512 Portable SSD	512GB
Wise	PTS-1024 Portable SSD	1TB
Wise	PTS-2048 Portable SSD	2TB

Formatting Storage Media using your Video Assist

It's very easy to format your storage media using the storage settings. You can format your card or drive using HFS+ or exFAT formats.

HFS+ is also known as Mac OS Extended. It is the recommended format as it supports "journaling". Data on journaled media is more recoverable and less likely to be corrupted. HFS+ is natively supported by Mac.

ExFAT is supported natively by Mac and Windows computers without needing to purchase any additional software. However, exFAT does not support journaling which means data is less protected against the rare event your media card is corrupted.

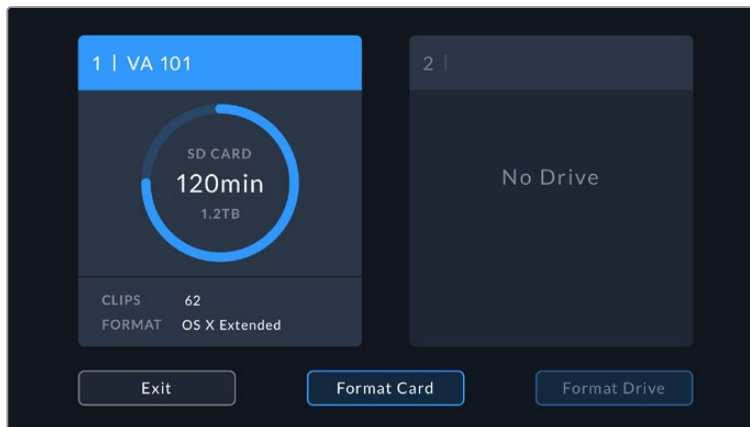

Your video assist can format your media in HFS+ or exFAT. Tap on the storage media icon to access settings.

To format your storage media:

- 1 Tap the storage status icons to open the storage settings.
- 2 Select the card or drive you want to format. This could be an SD card or external USB-C flash disk. To format a drive on 12G video assist models, tap 'drive list' and then select the drive you want to format to highlight it. Tap 'format drive'.

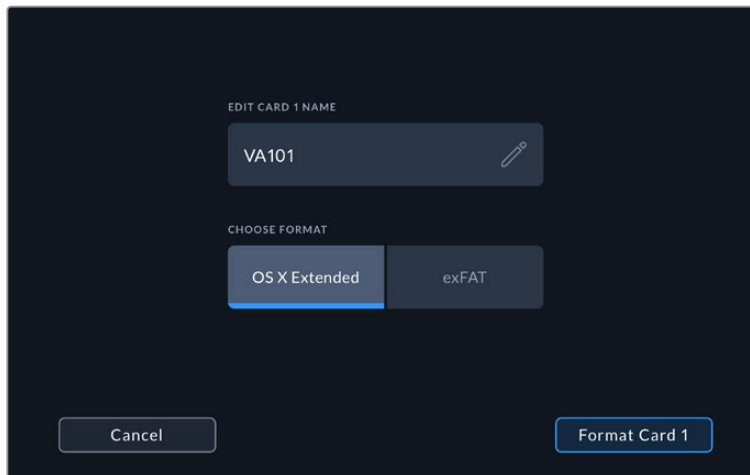

When formatting you can also add the name for your card or drive using the edit box

- 3 Select your desired HFS+ or exFAT format type, then tap the 'format card' icon again.
- 4 A warning will appear asking you to confirm the format. If your storage media contains data already recorded, make sure you back it up before formatting as this action cannot be undone. Hold down the 'format' icon for three seconds until the tick appears continue, or 'cancel' to cancel the format.
- 5 A progress bar shows you the progress of the format. 'Formatting complete' will appear when the formatting has finished.
- 6 Tap the 'ok' icon to return to the storage settings.

TIP You can also format storage while recording on another storage slot, for example, on the 7" video assist models you can format card 2 while recording to card 1.

Formatting Media using a Computer

SD cards and USB-C flash disks can also be formatted using a Mac or Windows computer.

Preparing SD Cards on a Mac computer

Use the 'disk utility' application included with Mac to format your media in the HFS+ or exFAT formats. If your storage media already has files recorded on them, remember to back up your media as all data will be lost when it is formatted.

- 1 Plug the SD card into your computer's SD card slot or via an SD card reader. For external drives, connect the drive to your computer via a USB-C cable.
- 2 Go to 'applications/utilities' and launch 'disk utility'.
- 3 Click on the disk icon of your SD card or drive and then click the 'erase' tab.
- 4 Set the format to 'Mac OS Extended (journaled)' or "exFAT".
- 5 Type a 'name' for the new volume and then click 'erase'. Your SD card or drive will quickly be formatted and made ready for use.

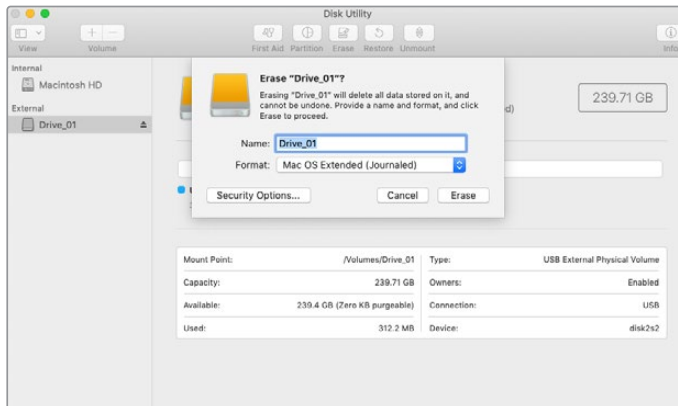

Use 'disk utility' on Mac to erase your USB-C flash disk in the Mac OS Extended (journaled) or exFAT format.

Preparing Storage Media on a Windows computer

The 'format' dialog box can format an SD card in the exFAT format on a Windows PC. Remember to back up anything important from your media as all data will be lost when it is formatted.

- 1 Plug an SD card into your computer's SD card slot or via an SD card reader. For external drives, connect the drive to your computer via a USB-C cable.
- 2 Open the 'start menu' or 'start screen' and choose 'computer'. Right-click on your SD card.
- 3 From the contextual menu, choose 'format'.
- 4 Set the file system to 'exFAT' and the allocation unit size to 128 kilobytes.
- 5 Type a volume label, select 'quick format' and click 'start'.
- 6 Your SD card or external disk will quickly be formatted and made ready for use.

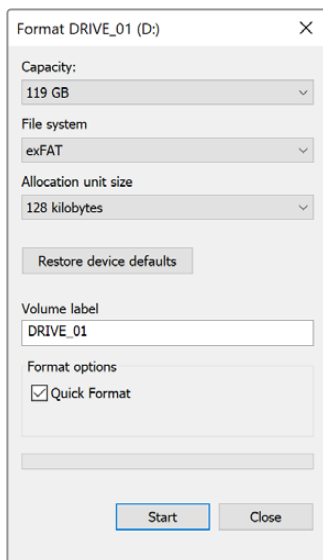

Use the 'format' dialog box feature in Windows to format your storage media in the exFAT format

Working with Files from SD Cards

You can access your ProRes or DNx files straight from your SD cards with any Mac or Windows computer that features an SD card slot or by using an SD card reader.

- 1 Remove the SD card from your video assist and insert it into the SD card slot of your computer, or SD card reader. The SD card can be accessed the same way as you would an external hard drive, USB drive or any other media storage device attached to your computer.
- 2 Double click on the SD card to open it and you should see a list of QuickTime or MXF movie files.
- 3 Now you can simply drag the files you want from the card onto your desktop or another hard drive, or you can access the files straight from the card using your NLE software.
- 4 Before you physically remove the SD card from the SD card slot, it's always a good idea to eject the card safely using either Mac or Windows first.

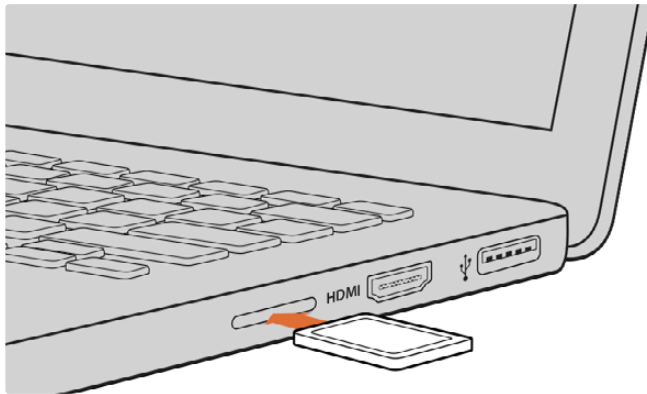

Insert your SD card into any computer with an SD card slot to access your clips immediately.

Checking Disk Speed

Blackmagic Disk Speed Test is a fun application that measures the read and write performance of storage media, then displays the results using video formats.

If you have ever wondered whether your storage media is suitable for recording (“write”) or playback (“read”) of a particular video format, you can use Disk Speed Test to find out. Test the performance of your media drives with a single click of the ‘start’ button! Disk Speed Test will even show you how many streams of video your storage is capable of handling.

Blackmagic Disk Speed Test software is available to download from the App Store. Windows and Mac installers are also included in Blackmagic Desktop Video, which you can download from the Blackmagic Design support center at www.blackmagicdesign.com/support.



Use Blackmagic Disk Speed Test to find out the performance of your SD card.

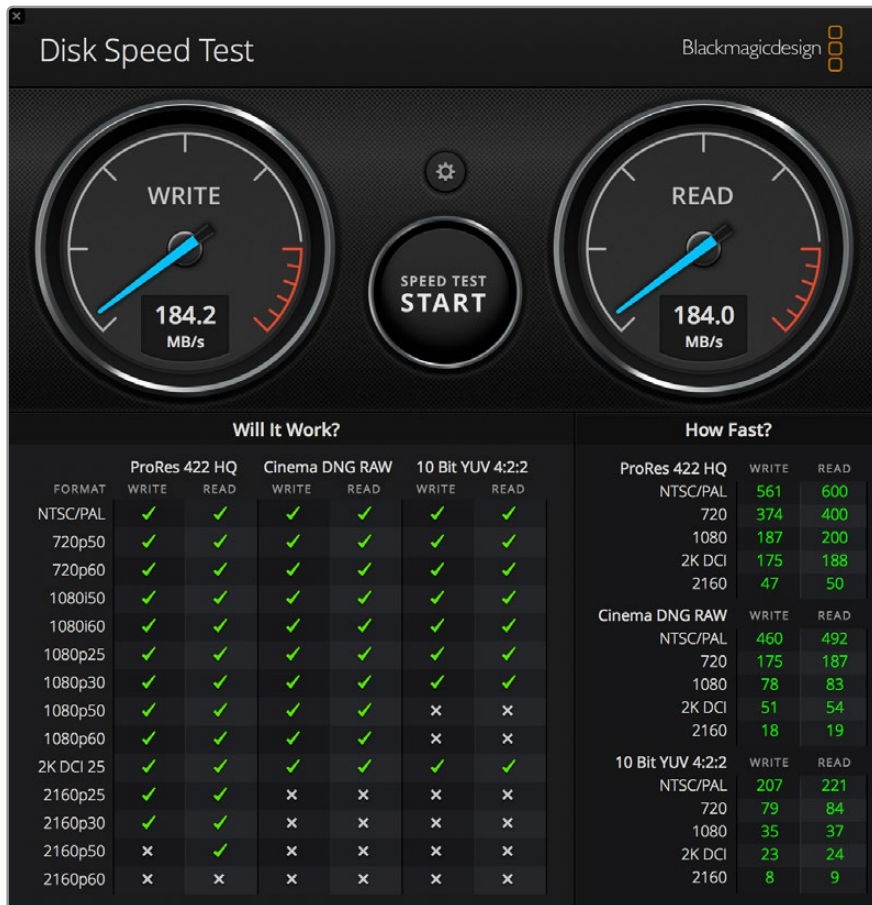

Blackmagic Disk Speed Test interface

Using Video Assist as a Webcam

When connected to a computer via USB, your Blackmagic Video Assist will be detected as a webcam. This means you can broadcast the playback or recording from your video assist using streaming software such as Open Broadcaster.

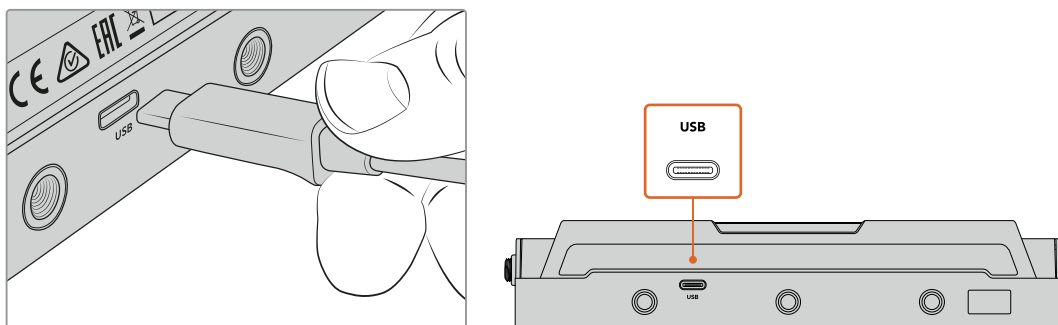

Connect your Video Assist to a computer using a USB-C cable

Setting the Webcam Source

In most cases, your streaming software will automatically set Video Assist as the webcam, so when you launch your streaming software you will see the picture from your Video Assist straight away. If your software doesn't select Video Assist, simply set the software to use Video Assist as the webcam and microphone.

Below is an example of how to set the webcam settings on Skype.

- 1 In Skype's menu bar, open the 'audio and video settings'.
- 2 Click on the 'Camera' drop down menu and select your Video Assist from the list. You will see the video from Video Assist appear in the preview window.
- 3 Now go to the 'microphone' drop down menu and select your Video Assist as the audio source.

With your Skype settings set correctly, perhaps try out a Skype call with a friend as a quick test to check your webcam setup is working.

That's all you need to do and Video Assist is now ready to broadcast your video to the world live!

Using Open Broadcaster

Open Broadcaster is an open source application that works as a streaming platform between your Video Assist and your favorite streaming software like YouTube, Twitch, Facebook Live, Vimeo Live and others. Open Broadcaster compresses your video to a bit rate that is easily managed by your streaming app.

Below is a demonstration of how to set up Open Broadcaster to stream the webcam output from your Video Assist using YouTube as the streaming application.

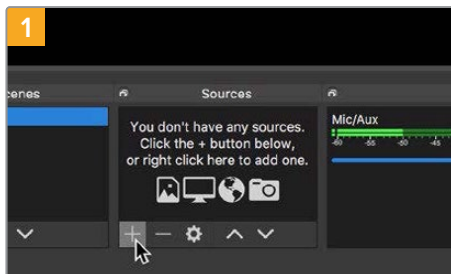

Launch Open Broadcaster and click on the plus symbol in the 'sources' box.

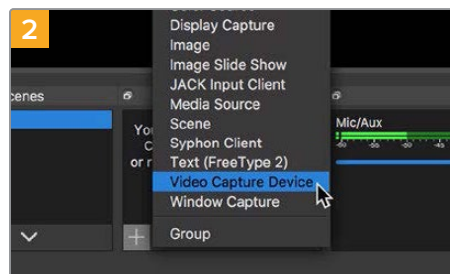

Select 'Video Capture Device'.

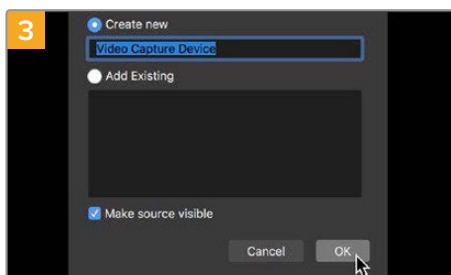

Name the new source and click 'OK'.

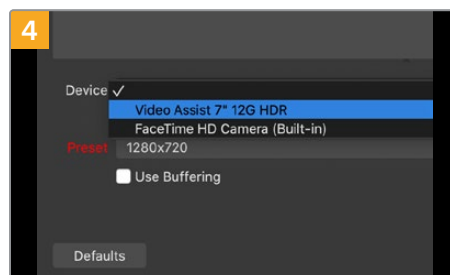

In the device drop down menu, select 'Video Assist' and click 'OK'.

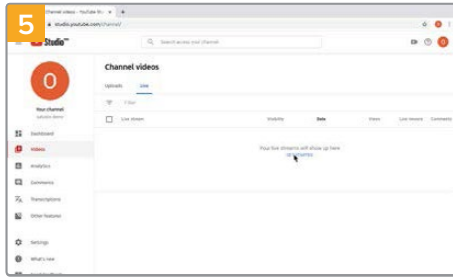

Now go to your YouTube account. Navigate to the 'video/live' option and click 'get started'.

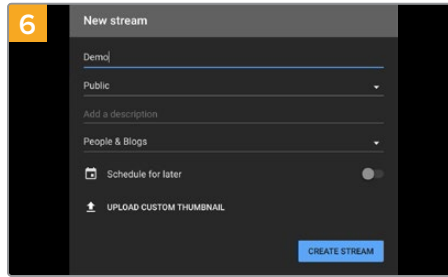

In the YouTube 'stream' options, enter your broadcast details and click 'create stream'.

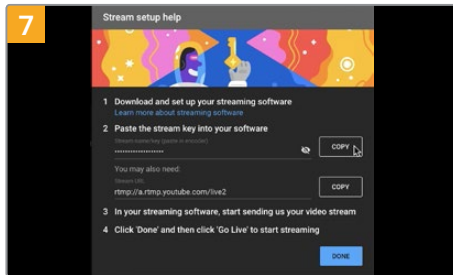

YouTube will now generate a stream name/key that will direct Open Broadcaster to your YouTube account. Click the 'copy' button next to the stream key. Copy the stream key that you will now paste into Open Broadcaster.

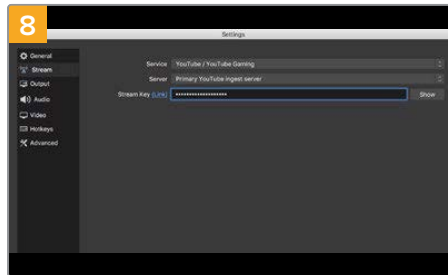

Return to Open Broadcaster and open the preferences by clicking on 'OBS preferences' in the menu bar. Select 'stream'. Now paste in the stream key you copied from YouTube and click 'OK'. You will now see the video from your Video Assist in the Open Broadcaster streaming preview window.

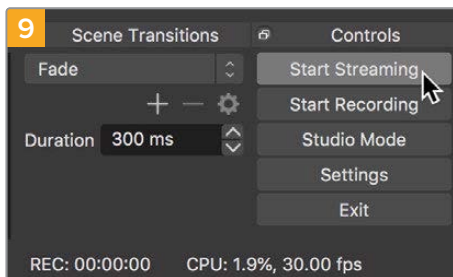

To connect Open Broadcaster's broadcast link to YouTube, click 'start streaming' in the bottom right corner of the screen. This establishes the link to YouTube from Open Broadcaster and from here everything will now be set using YouTube Live.

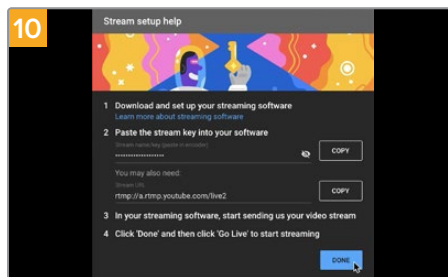

Go back to YouTube Live and you will see the webcam program output from your Video Assist in the background. Click 'done'.

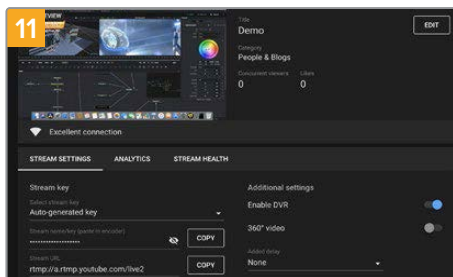

With Open Broadcaster now communicating with YouTube Live, you are ready to begin your broadcast. Now it's time to perform your final checks and make sure everything is good.

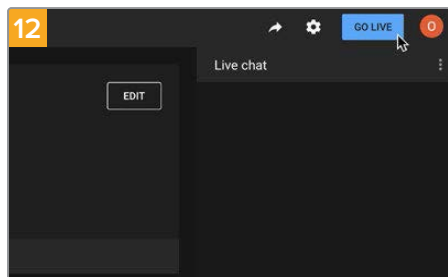

If you are all set, you can now begin your broadcast by clicking 'go live'.

You are now broadcasting live on YouTube with Open Broadcaster. When your broadcast is finished, you can end the stream by clicking 'end stream'.

NOTE Due to the nature of internet streaming there can often be a delay, so it's important to watch the stream on YouTube and confirm your program has finished before clicking 'end stream' to make sure you don't accidentally cut the end of your broadcast short.

Blackmagic Video Assist Setup

Updating the Internal Software

Updates for your video assist's internal software will be available on the Blackmagic Design website. We recommend downloading the software and updating your video assist so you can benefit from new features and improvements.

To update the internal software using Mac:

- 1 Download and unzip Blackmagic Video Assist Setup.
- 2 Open the resulting disk image and launch the Blackmagic Video Assist Setup Installer. Follow the onscreen instructions.
- 3 After installing the latest Blackmagic Video Assist Setup, connect a USB type C cable from your Video Assist to your computer.
- 4 Launch Blackmagic Video Assist Setup and follow any onscreen prompt to update the internal software. If no prompt appears, the internal software is up to date and there is nothing further you need to do.

To update the internal software using Windows:

- 1 Download and unzip Blackmagic Video Assist Setup.
- 2 You should see a Blackmagic Video Assist Setup folder containing this manual and the Blackmagic Video Assist Setup installer. Double-click the installer and follow the onscreen prompts to complete the installation.
- 3 After installing the latest Blackmagic Video Assist Setup, connect a USB type C cable from your video assist to your computer.
- 4 Launch Blackmagic Video Assist Setup and follow any onscreen prompt to update the internal software. If no prompt appears, the internal software is up to date and there is nothing further you need to do.

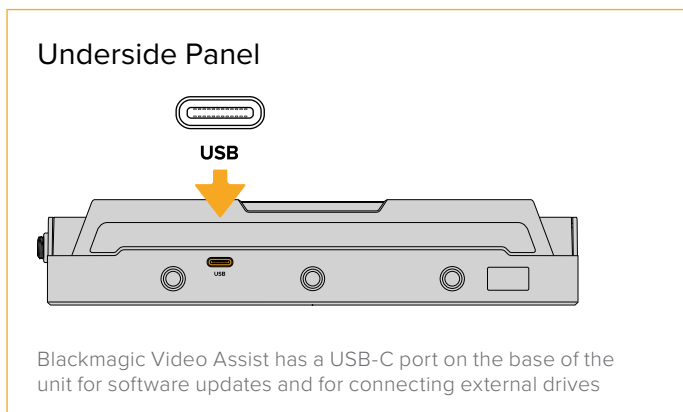

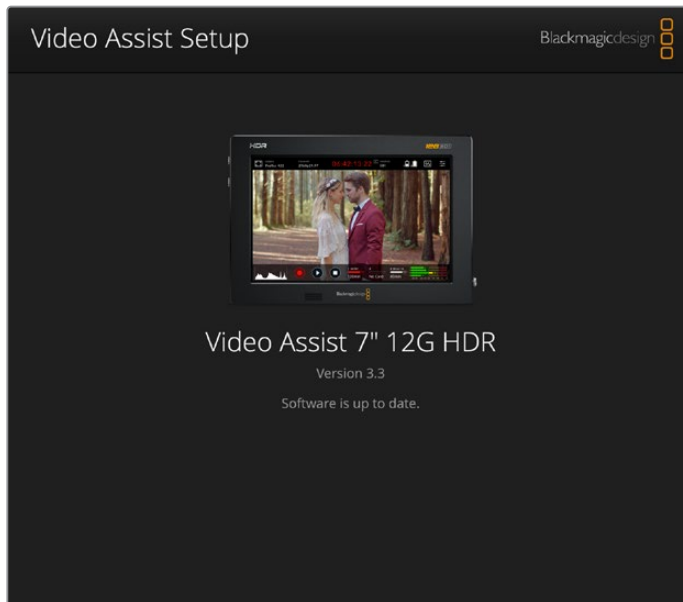

To update the internal software on your video assist, plug into your computer via the USB port, then download and launch the latest Blackmagic Video Assist Setup. Follow any on screen prompts. If no prompt appears, your internal software is already up to date.

Using DaVinci Resolve

Recording clips with your video assist is only part of the process of creating film and television content, and just as important is the process of media backup and management as well as editing, color correction and encoding final master files. DaVinci Resolve for Mac and Windows is included with your video assist so you have a complete solution for recording and post production!

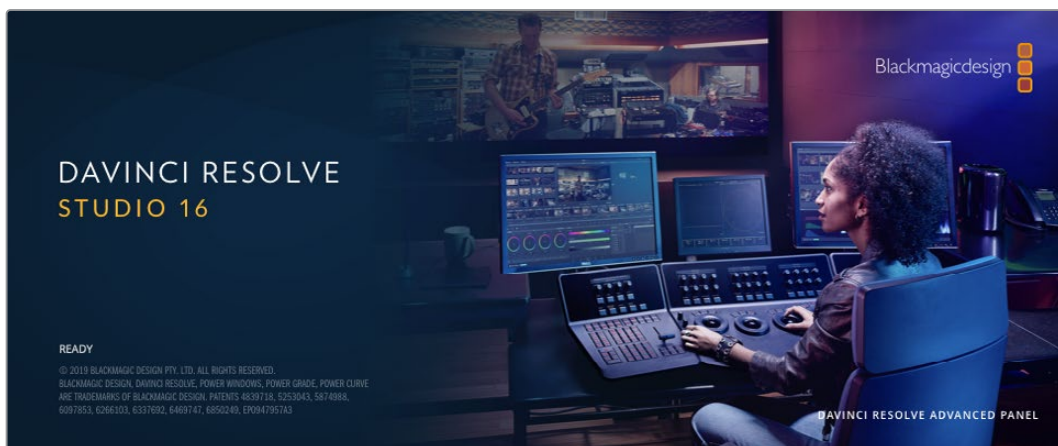

NOTE We recommend using the latest version of DaVinci Resolve for accurate color treatment of clips recorded with your Blackmagic Video Assist. For example, version 16 or later will ensure accurate color.

After connecting your SD card to your computer, you can use DaVinci Resolve's 'clone' tool, in the 'media' page, to create running backups as you shoot. This is recommended as any type of media is susceptible to becoming damaged or developing a fault so creating backups means your shots will be immune to loss. Once you have used DaVinci Resolve to back up your media, you can then add your clips to the DaVinci media pool, then edit, color correct, and finish your production without ever having to leave DaVinci Resolve.

DaVinci Resolve is the same tool used on most major blockbuster movies, so it's much more than a simple NLE software tool, as it has extremely advanced technology built in for high end digital film. You get the advantage of this technology when you use DaVinci Resolve to edit and color correct your work.

Included here is information on how to get started using DaVinci Resolve with your recorded clips. Of course, DaVinci Resolve is extremely advanced and includes a lot more features than you immediately see when first looking at its user interface. To learn more about how to use DaVinci Resolve, please check for the DaVinci Resolve instruction manual on the Blackmagic website, where you can also find many training courses and tutorial videos.

Project Manager

Before you import your clips and start editing, you will need to set up your project using the project manager.

The project manager is the first screen you will see when launching DaVinci Resolve, but you can open the manager at any time by clicking on the 'home' icon at the bottom right of the user interface. This is helpful when you want to open previous projects and create new ones.

To create a new project, click on 'new project' at the bottom of the window and give your project a name. Click 'create'.

Using the 'cut' page, you can start working on your edit immediately.

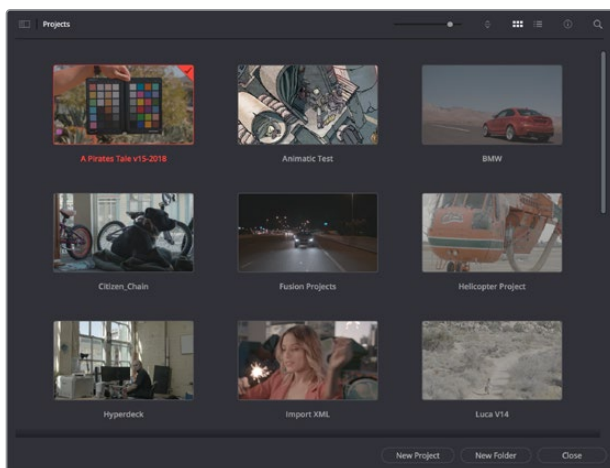

The project manager shows all projects belonging to the current user

For more information about the Project Manager, refer to the DaVinci Resolve manual which is available to download on the Blackmagic Design website support page.

Editing with the Cut Page

The 'cut' page gives you a fast, dynamic editing workflow that lets you quickly assemble, trim and edit clips efficiently.

Two active timelines let you work with your entire edit plus a detailed area simultaneously. This means you can drop clips anywhere on a large timeline, then refine your edit in a detailed timeline within the same workspace. Using this workflow, you can edit on a laptop without needing to zoom in and out and scroll as you work, which can be an enormous time saver.

The Cut Page Layout

When you open the cut page, you will see the media pool, viewer window and timeline. These three primary windows give you complete control over your edit.



The 'cut' page default workspace, with the media pool in icon view

For more information on the Cut page, see the 'Using the Cut Page' chapter in the DaVinci Resolve manual.

Media Tabs

At the top left corner of the user interface you will see five tabs.

Click on these tabs to open the media toolsets you will use when creating your edit. For example, the first tab is the media pool and you can see it is already selected. The other tabs are for the sync bin, media transitions, titles and effects.

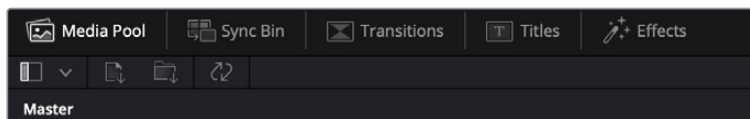

- **Media Pool:** The media pool contains all your clips, folders and files you imported using the media page. You can also import files directly from the cut page, so you don't have to go back to the media page if you want to import a new clip.
- **Sync Bin:** This powerful feature automatically syncs all your clips via timecode, date and time so you can choose angles from all cameras on a multi camera project.

- **Transitions:** If you click on the neighboring transitions tab, you will see all the video and audio transitions you can use in your edit. These include common transitions such as cross dissolves and motion wipes.
- **Titles:** Next to transitions is the ‘titles’ tab. Here you can select the title type you want to use. For example a scroll, standard text or lower thirds title. There are also a list of Fusion templates you can use for more animated dynamic titles which can be customized in DaVinci Resolve’s ‘Fusion’ page.
- **Effects:** The fifth tab is the ‘effects’ tab. This provides all the different filters and effects you can use to bring more life to your edit, for example customizable blurs, glows and lens effects. There are many powerful effects to choose from and you can find them quickly using the search tool.

TIP Use the search tool near the media tab icons to find the exact items you are looking for. For example, if you have the transitions tab selected, type “dissolve” in the search tool and only dissolve transition types will be shown in the viewer, making it quicker for you to find the dissolve transition you want.



Viewer Tabs

In the top left corner of the viewer window you will see the viewer mode buttons.



The viewer mode buttons

These buttons control which viewer is currently being used, including ‘source clip’, ‘source tape’, and ‘timeline’. These viewer modes give you an enormous amount of control when selecting clips for your edit and it’s worth spending a moment to look at how they work.



	Source Clip	The source clip viewer displays a single clip from the media pool and you can set in and out points along the entire length of the viewer timeline. This gives you greater control. Select a source clip to view by double clicking on a clip in the media pool, or dragging it into the viewer.
	Source Tape	Source tape lets you view all the source clips in the media pool. This powerful feature is helpful if you want to quickly search through all your clips to find a specific event. As you scrub the playhead over the clips, you will see their thumbnails selected in the media pool. This means once you have found the clip you want to edit, you can click on the source clip tab and its corresponding source clip will appear in the viewer automatically. The source tape viewer really lets you take advantage of non-linear editing, giving you the freedom to work on your edit, find shots quickly, try new ideas and stay in the moment.
	Timeline	The timeline viewer lets you view the edit timeline so you can play back your project and refine your edits.

Importing Clips to the Media Pool

Now you can start importing media into your project. You can do this in the media pool window of the cut page using the import tools at the top.



Select one of the import options to add media to your project

	Import Media	The import media option will import individual media files selected from your storage location.
	Import Media Folder	To import a folder from your media storage, select the import folder option. When importing a folder, DaVinci Resolve will keep the file structure, treating each folder as a separate bin so you can navigate between bins to find your videos and other media files.

To import media:

- 1 Click on the import file or import media icon.
- 2 Navigate to your media storage for the media you want to import.
- 3 Select the file or folder and click 'open'.

Once you've added media to your project, it is a good time to save your changes. DaVinci Resolve features a fast, on the go autosave called 'live save'. Once you save your project once, 'live save' will save further changes as you make them, removing the risk of losing your work.

For more information on 'live save' and other auto save functions, refer to the DaVinci Resolve Manual.

Adding Clips to the Timeline

Now that you are familiar with the media tabs and viewer mode buttons, you can open the media pool and quickly start adding clips to your timeline.



The timeline of the cut page, comprising the upper timeline and the zoomed in timeline below

The timeline is where you will build your edit and is like a board with tracks you can attach clips to, move them around and trim their edits. Tracks let you layer clips over others which gives you more flexibility to try different edits and build transitions and effects. For example, you can try an edit with a clip on one track without affecting other clips on tracks below it.

There are different ways to add clips to the timeline, such as smart insert, append, place on top and more.

Appending Clips

When selecting takes and assembling an edit, you will likely want to add these shots to your timeline one after the other. The append tool is perfect for this task and will get you editing very fast.

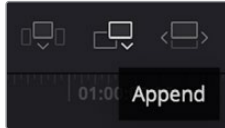

Click on the append icon to quickly add clips to the end of the last clip

To append a clip:

- 1 Double click on a clip in the media pool to open it in the viewer.
- 2 Using the scratch trim tool, drag the in and out points to select the precise duration of your shot. You can also press the 'i' and 'o' keyboard shortcuts to set in and out points.



- 3 Now click the 'append' icon underneath the media pool.



Your first clip will be placed at the head of the timeline.

Repeat steps 1 to 3 to keep adding more clips and they will automatically append, ensuring there are no gaps in the timeline.

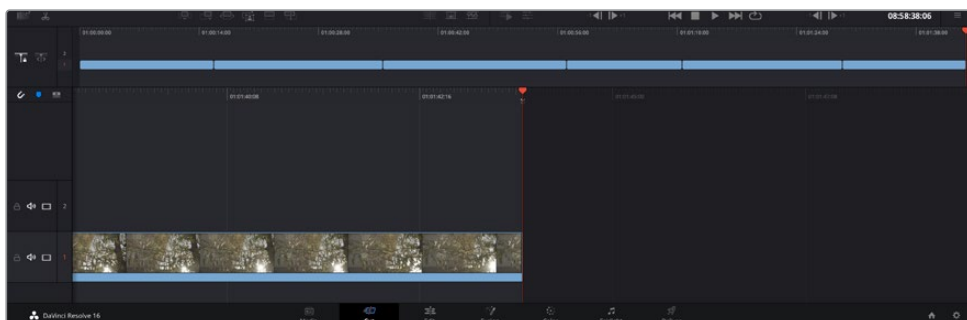

Appending clips ensures there are no gaps between them on the timeline

TIP You can speed up the process further by assigning a keyboard shortcut to the 'append' icon. For example, if you assign the 'P' key, you can set your in and out points using 'I' and 'O' then press 'P' to append the clip. Refer to the DaVinci Resolve manual for information on how to assign shortcut keys.

Editing Clips on the Timeline

With clips added to the timeline, you have complete control to move them around and trim edits.

To trim an edit, hover the mouse over the start or end of a clip, then click and drag it left or right. For example, drag the end of the clip left or right to decrease or increase its duration. You might notice that all clips after that edit will shift on the timeline to accommodate the new adjustment. This is one way the 'cut' page helps to save you time.

You can even pick the clip up and drop it on a new video track in the large timeline without having to zoom in or out. This speeds up the edit process because it minimizes time navigating a long timeline.

After you have finished editing clips using the 'cut' page, you might want to add a title. The next section will show you how.

Adding Titles

Placing a title on your timeline is easy and you have many options.

To see the different types of titles you can use, click on the 'titles' media tab at the top left corner of the user interface. In the selection window you will see all the different title generators you can use, from lower thirds, scrolls, to a standard text title. You can even add any of the Fusion titles which are animated titles that you can customize.

A good example is to add a standard title.

To do this:

- 1 Click on the 'text' title and drag it onto the timeline. It doesn't matter which timeline, but for greater accuracy we recommend using the detailed timeline. The title will automatically create a new video track for the title and will snap to the playhead.
- 2 Release the mouse and the title will appear on the new track. You can now move it or change its duration like you would another video clip.
- 3 To edit the title, click on the new title clip and a 'tools' icon will appear underneath the clip viewer. Click on the tools icon.

You will now see a row of tools you can use to modify the title clip. For example transform, crop, dynamic zoom and more. For this example, click on the 'title' tool.
- 4 Now click 'open inspector'.

This will open the inspector window where you can type in the title you want and edit the text settings, for example tracking, line spacing, font type, color and more.

You have a lot of options to customize the title exactly how you want it. We recommend playing with all the different settings to see how they can change the appearance and shape of your title.

Working with Blackmagic RAW Files

Blackmagic RAW clips give you maximum flexibility in post production. This lets you make adjustments to clips, such as white balance and ISO settings, as if you were changing the original camera settings. Working with Blackmagic RAW also retains more tonal information within shadows and highlights, which is useful for recovering details, for example in blown out skies and dark areas of the picture.

It's worth shooting in Blackmagic RAW if you are after the highest possible quality, or for shots where there is an extreme variance between highlights and shadows and you may need to push and pull those regions as much as possible in the grade.

The speed and small file size of Blackmagic RAW means you don't need to make proxy files and playback is just like a standard video clip. This section of the manual describes the features of Blackmagic RAW and how to use Blackmagic RAW files in your DaVinci Resolve workflow.

TIP It is a good practice to adjust the Blackmagic RAW settings for your clips on the 'color' page before you start color grading.

Clip Settings for Blackmagic RAW

When you first import Blackmagic RAW files, DaVinci Resolve will decode the camera data contained in the files using the ISO, white balance and tint settings used at the time of shooting. If you're happy with the look of these settings, you can start editing right away.

The great thing about shooting Blackmagic RAW is that you're not tied to these settings at all! The breadth of available post processing options when working with Blackmagic RAW files mean that you'll develop your own workflow over time. Experimenting with the 'clip' settings for each clip in the 'camera raw' tab will show you just how powerful and flexible working with Blackmagic RAW can be.

For Blackmagic RAW files from 12G video assist models, you have the flexibility to use the camera's original gamut and gamma, or treat them as you would other .braw files using the Blackmagic Design color space and a Blackmagic gamma, such as Blackmagic Design Film.

Using the default camera settings

With your clip selected on the 'color' page, go to the 'camera raw' tab in the lower left corner. You will notice on the left hand side that the color space and gamma settings match your camera settings. You can change the exposure for any file by dragging the slider control. You can also adjust the white balance for files shot using Panasonic EVA1 using the color temp and tint sliders.

Using Blackmagic RAW settings

To use the Blackmagic color space, simply select Blackmagic Design from the drop down 'color space' menu and then select a Blackmagic Design gamma. Now you have all the gamma controls of .braw files recorded on Blackmagic Design cameras. It's worth noting that highlight recovery and ISO controls are disabled for Blackmagic RAW clips recorded on Video Assist 12G HDR.

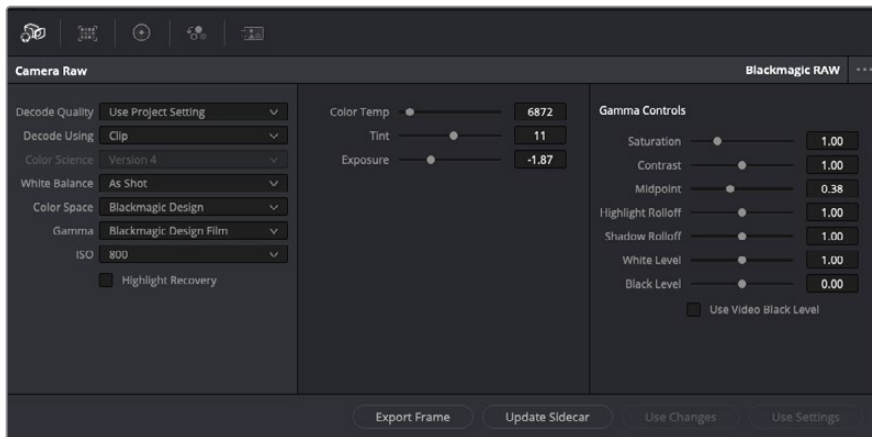

In the 'camera raw' tab, select 'clip' from the 'decode using' drop down menu to make adjustments to your clip's Blackmagic RAW settings

Once you have set DaVinci Resolve to enable clip settings for Blackmagic RAW, the clip settings and gamma controls are now adjustable. Adjusting these settings to optimize your clips can bring them close to a full primaries grade. This is especially powerful when using DaVinci Resolve's scopes which can help you neutralize and balance the clips ready for applying a look.

The following information contains descriptions for the clip and gamma controls.

ISO

The ISO value can be changed by increasing or decreasing this setting. This setting is helpful if you need to set the clip to a brighter or darker starting point for optimization.

Highlight Recovery

Check the box to reconstruct highlight information in clipped channels using information from non-clipped channels.

Color Temp

Adjust the color temperature to warm or cool the image. This can be used to help neutralize the color balance in each image.

Tint

Adjusting this setting will add green or magenta into the image to help balance the color.

Exposure

Use this setting to refine the overall brightness of the image.

Saturation

Saturation controls default at 1 and range from -1 for the minimum saturation to +4 for maximum saturation.

Contrast

Defaulting at 1.0, drag the slider to the left for the least amount of contrast at 0 or to the right to increase the contrast up to 2.

Midpoint

In Blackmagic Design Film, your middle gray value defaults to 0.38, or 38.4%. Drag the slider to the left to lower your midpoint or to the right to raise it to 100. When contrast is adjusted away from the default setting, you can modify your highlight and shadow rolloff.

Highlight Rolloff

Adjust the highlights by dragging the slider to the left to lower the value to 0, or to the right to increase the highlights to 2. The default value is 1.

Shadow Rolloff

Drag the slider to the left to lower your shadows to 0 or to the right to raise your shadows to 2.

White Level

Adjust the white point of the gamma curve by dragging the slider from the highest value of 2 to the lowest value of 0. The default value is 1.

Black Level

Raise the black point of the custom gamma curve by dragging the slider to the right from the lowest value of -1 to a maximum of 1. The default value is 0.

Use Video Black Level

Check the box to set your black levels to video.

Export Frame

Clicking the 'export frame' button lets you export a single frame from your Blackmagic RAW clip.

Update Sidecar

Click this button to update the Blackmagic RAW sidecar file for the current clip.

Any changes you have made to your Blackmagic RAW clips will be identified by the gamma setting changing to Blackmagic Design Custom.

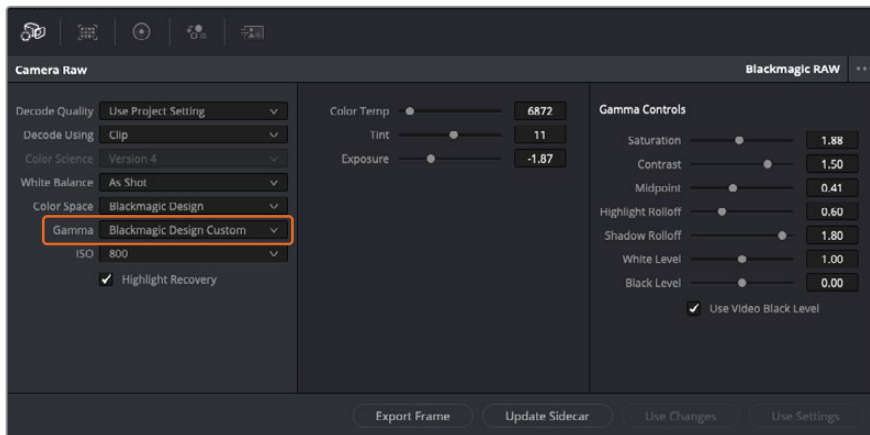

If you want to revert your clip to one of the default gamma options available, simply select it from the gamma dropdown menu.

TIP Gamma controls are disabled for footage shot with the 'video' dynamic range, but you have not lost your Blackmagic RAW data. Simply select Blackmagic Design Film or Blackmagic Design Extended Video from the dropdown gamma menu and make your adjustments.

Saving your Blackmagic RAW changes

- 1 Adjust the gamma controls for your Blackmagic RAW clip.
- 2 Click the 'update sidecar' button.

A 'sidecar' file will now be created in the same folder as your .braw file. When another user imports the Blackmagic RAW files, the sidecar files will automatically be read by DaVinci Resolve. If you make additional adjustments, press 'update sidecar' again.

TIP To remove your sidecar file, you can simply delete it from its location on your media drive.

Project Settings for Blackmagic RAW

If you need to make a setting change that is common to all the clips, for example a global change to the white balance or ISO setting, you can set the clips to use the project 'camera raw' settings and make global changes from there.

To set project settings for Blackmagic RAW:

- 1 Enter the project settings menu by clicking 'file,' and selecting 'project settings.'
- 2 In the 'Camera RAW' tab, you'll see a dropdown menu next to RAW profile. Click on the arrow to select Blackmagic RAW from the list.
- 3 Select 'project' in the 'Decode Using' dropdown menu.
- 4 Set the white balance setting to 'custom'.
- 5 Select 'Blackmagic Design Custom' from the dropdown gamma menu. Set the color space to 'Blackmagic Design'. This will also set the gamma setting to 'Blackmagic Design Film'.
- 6 Choose your resolution from the 'Decode Quality' menu. A lower resolution will give you better playback on limited systems. You also have the flexibility to change to full resolution later on before delivery for the highest quality output.

Now you can adjust the camera settings for your clips such as saturation, contrast and midpoint. This will affect all clips in your project that are set to decode using 'project'.

Color Correcting your Clips with the Color Page

Now with your clips on the timeline and titles added, you can start color correcting using the 'color' page. The color page is extremely powerful and will define the overall look of your film, but for this example a good place to start is to neutralize all your clips so they are consistent. You can also return to the 'cut' or 'edit' page at any time if you want to make changes to your edit.

The color page lets you adjust the look of your edit and in many ways color correction is an art form in itself. You are really adding emotion to your work when you add color correction. It's an incredibly creative part of the workflow and very satisfying when you learn these skills and can see your work come alive! This is usually the first step and is referred to as primary color correction, or adjusting the primaries. After primary color correction is done, you can then make secondary color correction adjustments which is where you can make extremely precise color adjustments of specific objects in your images. That is a lot of fun, but is normally done after primaries because it helps make the process more efficient and you will get a better result!

First click on the 'color' tab to open the color page.

You'll see the camera raw settings, color wheels, curves palettes and general color correction tools as well as the preview and nodes window. Don't feel overwhelmed by the vast array of features in front of you, they are all there to help you get the most amazing looking pictures. This getting started section will show the basics, but for more detailed information refer to the

relevant sections in the manual. They will show you exactly what all the tools are for and how to use them in easy to follow steps. You'll learn the same techniques the professionals use in high end color correction facilities.

Generally, the first step for primary color correction is to optimize the levels for shadows, mid tones and highlights in your clips. In other words adjust the 'lift', 'gamma' and 'gain' settings. This will help get your pictures looking their brightest and best with a clean, balanced starting point from where you can begin grading the 'look' of your film. To optimize the levels, it's helpful to use the scopes.

Using Scopes

Most colorists make creative color choices by focusing on the emotion and the look they want their program to have and then simply work using the monitor to achieve that look. You can look at everyday objects and how different types of light interact with them to generate ideas on what you can do with your images and a little practice.

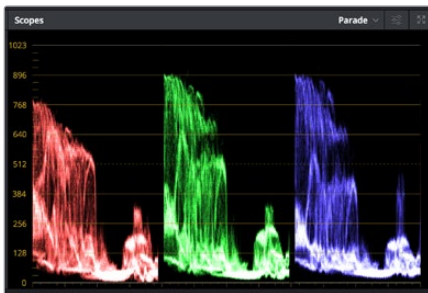

The parade scope helps you optimize highlights, mid tones and shadows

Another way to color grade is to use the built in scopes to help you balance shots. You can open a single video scope by clicking the 'scope' button, which is the second from the right on the palette toolbar. You can choose to display a waveform, parade, vectorscope and histogram. Using these scopes you can monitor your tonal balance, check the levels of your video to avoid crushing your blacks and clipping the highlights, plus monitor any color cast in your clips.

The 'color wheels' palette contains the 'lift', 'gamma' and 'gain' controls which will generally constitute your first adjustment. If you've previously had experience with color correction, these should resemble controls you've seen in other applications for doing color and contrast adjustments.



The 'lift', 'gamma', 'gain' and 'offset' color wheels give you total control over the color and tonal balance of your clips. To make a uniform adjustment to all colors for each tonal region, drag the dial underneath the color wheels back and forth

For more accurate control of each color using a mouse, you can change the color wheels to 'primaries bars' which let you adjust each color and luminance channel for the lift, gamma and gain controls separately. Simply select 'primaries bars' from the dropdown menu near the top right of the color wheels.

- **Adjusting the 'lift':** With your clip selected on the color timeline, click on the 'lift' dial underneath the first color wheel. Slide it back and forth and watch how it affects your image. You'll see the brightness of the dark regions of your picture increase and decrease.
Set it to where you want the dark areas to look their best. If you decrease the lift too much, you'll lose details in the blacks and you can use the parade scope to help avoid this. The optimal position for blacks on the waveform is just above the bottom line of the parade scope.
- **Adjusting the 'gain':** Click on the 'gain' dial and slide it back and forth. This adjusts the highlights which are the brightest areas of your clip. The highlights are shown on the top section of the waveform on the parade scope. For a brightly lit shot, these are best positioned just below the top line of the waveform scope. If the highlights rise above the top line of the waveform scope, they will clip and you will lose details in the brightest regions of your image.
- **Adjusting the 'gamma':** Click on the 'gamma' dial underneath the color wheel and slide it back and forth. As you increase the gamma you'll see the brightness of the image increase. Notice the middle section of the waveform will also move as you adjust the gamma. This represents the mid tones of your clip. The optimal position for mid tones generally falls between 50 to 70% on the waveform scope. However, this can be subjective based on the look you are creating and the lighting conditions in the clip.

You can also use the curves palette to make primary color corrections. Simply click to create control points on the diagonal line inside the curve graph, and drag them up or down to adjust the master RGB contrast at different areas of image tonality. The optimum points to adjust are the bottom third, mid, and top third of the curve line.

There are many more ways of doing primary color correction in DaVinci Resolve.

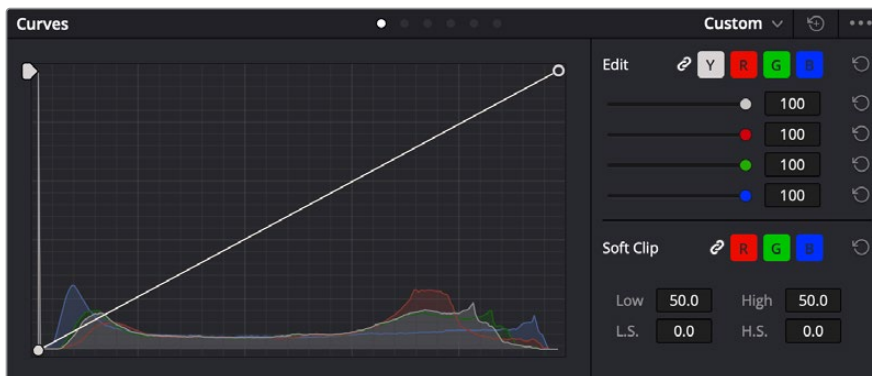

The curves palette is another tool you can use to make primary color corrections, or enhance specific areas of your clip when using a power window

Secondary Color Correction

If you want to adjust a specific part of your image then you need to use secondary corrections. The adjustments you have been doing up until now using the lift, gamma and gain adjustments affect the whole image at the same time and so they are called primary color corrections.

However, if you need to adjust specific parts of your image, say for example you wanted to improve the color in the grass in a scene, or you wanted to deepen the blue in a sky, then you can use secondary corrections. Secondary color corrections are where you select a part of the image and then adjust only that part. With nodes, you can stack multiple secondary corrections so you can keep working parts of your image until everything is just right! You can even use windows and tracking to allow the selections to follow movement in your images.

Qualifying a Color

Often you'll find a specific color in your clip can be enhanced, for example grass by the side of a road, or the blue in a sky, or you may need to adjust color on a specific object to focus the audience's attention on it. You can easily do this by using the HSL qualifier tool.



Using the HSL qualifier to select colors in your image is helpful when you want to make areas of your image 'pop', to add contrast, or to help draw the audience's attention to certain areas of your shot

To qualify a color:

- 1 Add a new serial node.
- 2 Open the 'qualifier' palette and make sure the 'selection range' picker tool is selected.
- 3 Click on the color in your clip you want to affect.
- 4 Usually you'll need to make some adjustments to soften the edges of your selection and limit the region to only the desired color. Click on the 'highlight' button above the viewer to see your selection.
- 5 Adjust the 'width' control in the 'hue' window to broaden or narrow your selection.

Experiment with the high, low and softness controls to see how to refine your selection. Now you can make corrections to your selected color using the color wheels or custom curves.

Sometimes your selection can spill into areas of the shot you don't want to affect. You can easily mask out the unwanted areas using a power window. Simply create a new window and shape it to select only the area of color you want. If your selected color moves in the shot, you can use the tracking feature to track your power window.

Adding a Power Window

Power windows are an extremely effective secondary color correction tool that can be used to isolate specific regions of your clips. These regions don't have to be static, but can be tracked to move with a camera pan, tilt or rotation, plus the movement of the region itself.



Use power windows to mask out areas you don't want to be affected by the HSL qualifier secondary adjustments

For example, you can track a window on a person in order to make color and contrast changes just to that person without affecting his or her surroundings. By making corrections like this you can influence the audience's attention on areas you want them to notice.

To add a power window to your clip:

- 1** Add a new serial node.
- 2** Open the 'window' palette and select a window shape by clicking on a shape icon. Your selected window shape will appear on the node.
- 3** Resize the shape by clicking and dragging the blue points around the shape. The red points adjust the edge softness. You can position the shape by clicking the center point and moving it to the area you want to isolate. Rotate the window using the point connected to the center.

Now you can make color corrections to your image in just the area you want.

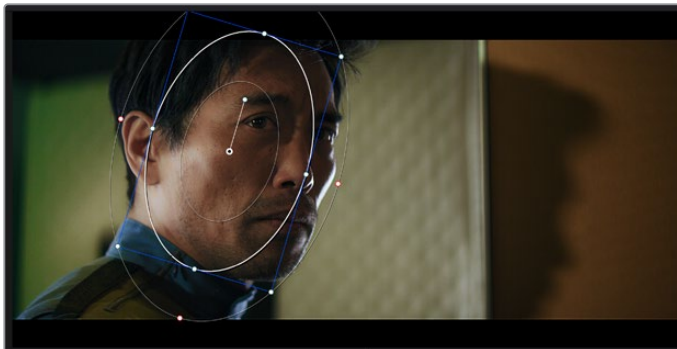

Power windows let you make secondary corrections to specific parts of your image

Tracking a Window

The camera, object or area in your shot may be moving, so to make sure your window stays on your selected object or area, you can use DaVinci Resolve's powerful tracking feature. The tracker analyzes the pan, tilt, zoom and rotation of the camera or object in your clip so you can match your windows to that movement. If this isn't done, your correction can move off the selected target and call attention to itself, which you probably don't want.

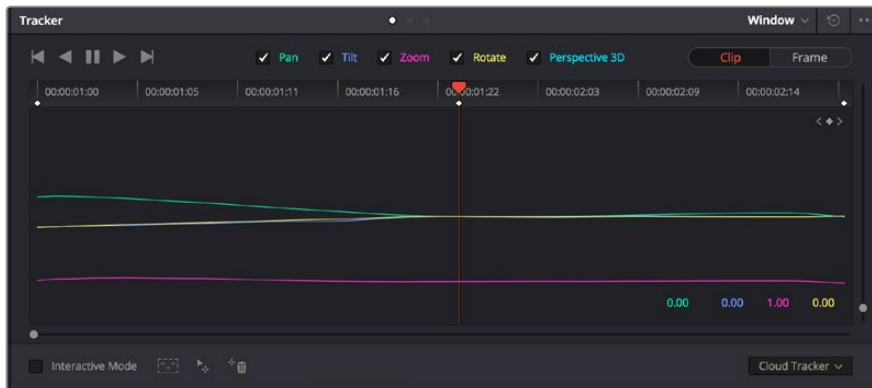

You can track objects or areas in your clip using the tracker feature so power windows can follow the action

To track a window to a moving object:

- 1 Create a new serial node and add a power window.
- 2 Go to the start of your clip and position and size the window to highlight just the object or area you want.
- 3 Open the 'tracker' palette. Select the pan, tilt, zoom, rotate, and perspective 3D settings appropriate for the movement in your clip by checking or unchecking the relevant 'analyze' checkboxes.
- 4 Click on the 'forward' arrow to the left of the checkboxes. DaVinci Resolve will now apply a cluster of tracking points on your clip and then step through the frames to analyze the movement. When the tracking is done, your power window will follow the path of the movement in your clip.

Most of the time automatic tracking is successful, but scenes can be complex and sometimes an object can pass in front of your selected area, interrupting or affecting your track. This can be solved manually using the keyframe editor. Refer to the DaVinci Resolve manual to find out more.

Using Plugins

While making secondary color corrections you can also add ResolveFX or OpenFX plugins to create fast, interesting looks and effects using the 'color' page, or imaginative transitions and effects on your clips on the 'edit' page. ResolveFX are installed with DaVinci Resolve, OFX plugins can be purchased and downloaded from third party suppliers.

After installing a set of OFX plugins, you can access them or ResolveFX plugins on the color page by opening the OpenFX inspector to the right of the 'node editor'. Once you create a new serial node, simply click the 'OpenFX' button to open the FX library and drag and drop a plugin onto the new node. If the plugin has editable settings, you can adjust these in the adjoining 'settings' panel.

In the 'edit' page you can add plugin filters, generators and transitions to clips by opening the 'OpenFX' panel in the 'effects library' and dragging your selected plugin onto the video clip or track above your clip on the timeline depending on the plugin requirements.

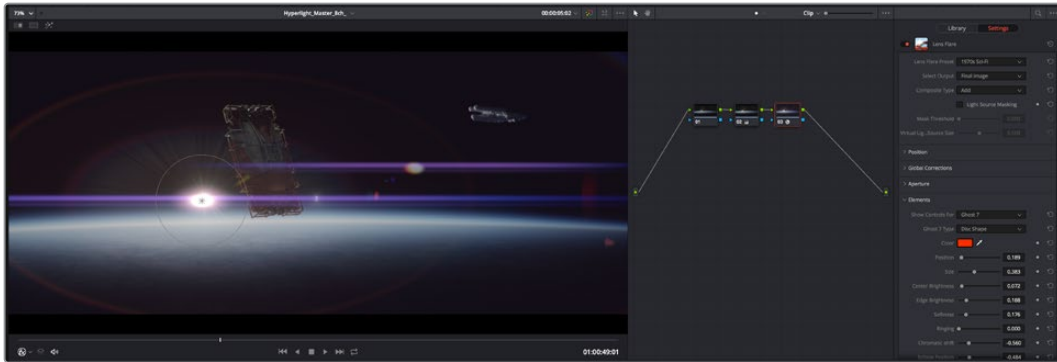

OFX plugins are a quick and easy way to create an imaginative and interesting look

Mixing Your Audio

Mixing Audio in the Edit Page

Once you have edited and color corrected your project, you can begin to mix your audio. DaVinci Resolve has a helpful set of features for editing, mixing and mastering audio for your project directly in the 'edit' page. For projects requiring more advanced audio tools, the Fairlight page provides you with a full audio post production environment. If you are already familiar with the edit page and want to move straight to Fairlight, skip this section and move onto the next.

Adding Audio Tracks

If you are working in the edit page and want to mix a basic sound edit with lots of sound effects and music, you can easily add more audio tracks when you need them. This can be helpful when building your sound, and separating your audio elements into individual tracks, for example, dialogue, sound effects and music.

To Add an Audio Track to the Edit Page

Right click next to the name of any audio track on your timeline and select 'add track' and choose from the options, including 'mono', 'stereo', and '5.1'. This will add the track to the bottom of the track list. Alternatively select 'add tracks' and select the position you would like the new track or multiple tracks placed.

Your new audio track will appear on the timeline.

TIP If you wish to change the type of track after creating it, right click next to the name of the track and select 'change track type to' and select the type of audio track you want, such as stereo, mono or 5.1.

Adjusting Audio Levels in the Timeline

Each clip of audio in the timeline has a volume overlay that lets you set that clip's level by simply dragging it up or down with the pointer. This overlay corresponds to the Volume parameter in the Inspector.

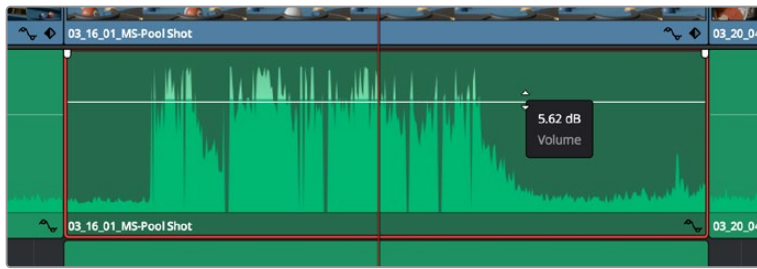

Dragging a volume overlay to adjust the clip level

For projects requiring more advanced audio tools, the Fairlight page provides you with a full audio post production environment.

The Fairlight Page

The 'Fairlight' page in DaVinci Resolve is where you adjust your project audio. In single monitor mode, this page gives you an optimized look at the audio tracks of your project, with an expanded mixer and custom monitoring controls that make it easy to evaluate and adjust levels in order to create a smooth and harmonious mix. Don't feel overwhelmed by the vast array of features in front of you, they are all there to help you deliver the best audio quality for your project.



This guide provides a basic overview of the features on the Fairlight page, but to learn more about all the details for each feature, refer to the DaVinci Resolve manual. The DaVinci Resolve manual provides details on the purpose of each tool and describes how to use them in easy to follow steps.

The Audio Timeline

- **Track Header:** At the left of each track is a header area that displays the track number, track name, track color, audio channels, fader value and audio meters. The track header also contains different controls for locking and unlocking tracks, plus solo and muting controls. These controls can help to keep your tracks organized, and let you preview individual tracks one at a time.
- **Tracks:** Each track on the Fairlight page is divided into lanes, which show each individual channel of clip audio for editing and mixing. The edit page hides these individual audio channels, displaying only a single clip in the timeline to make it easier to edit multi channel sources without needing to manage a huge number of tracks.

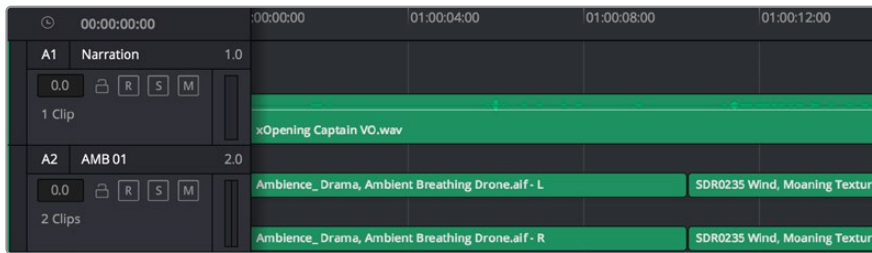

The track header on track A1 indicates a mono track with a single lane for mono audio, and the A2 track header indicates a stereo track with two lanes to accommodate stereo audio

What is a Bus?

A bus is essentially a destination channel to which you can route multiple audio tracks from the timeline, so that they are mixed together into a single signal that can be controlled via a single channel strip.

- **Main Bus:** 'Main busses' are typically the primary output of a program and each new project you create starts out with a single 'main bus', to which all tracks are routed by default. The 'main bus' combines all of the tracks in the timeline into one signal so that you can adjust the overall level of the audio mix once you have adjusted the level of each individual track.
- **Sub Bus:** 'Sub busses' allow you to combine multiple tracks of audio that belong to the same category such as dialogue, music or effects so that everything in that category can be mixed as a single audio signal. For example, if you have five dialogue tracks, you can route the output of all five dialogue tracks to a 'submix bus', and the level of all dialogue can then be mixed with a single set of controls. This submix can be rendered separately or sent to the main bus for render.

The Mixer

Each audio track in your timeline corresponds to an individual channel strip in the Mixer, and by default there's a single strip on the right for the 'main bus' labeled 'M1'. Additional channel strips will appear on the right hand side with a set of controls for each additional 'main' and 'submix bus' you create. A set of graphical controls allows you to assign track channels to output channels, adjust EQ and dynamics, set levels and record automation, pan stereo and surround audio, and mute and solo tracks.

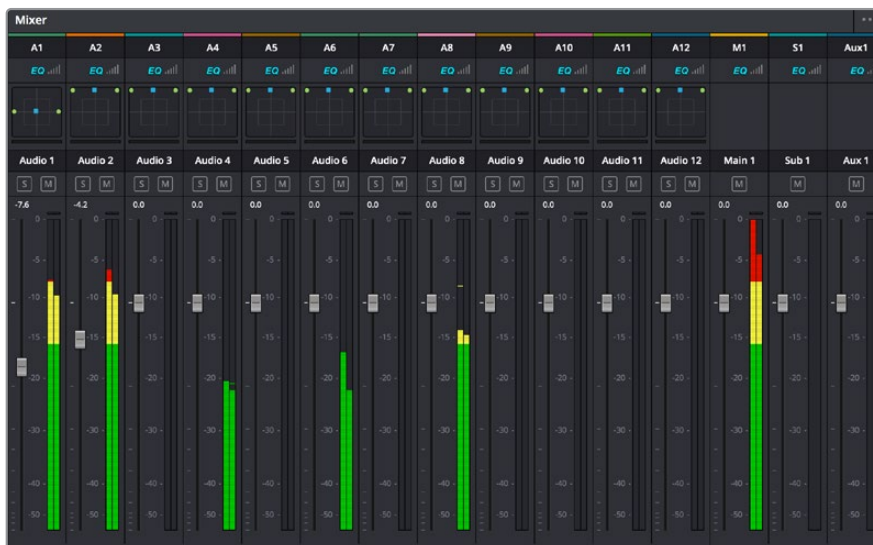

The audio mixer, with channel strips corresponding to the tracks in the timeline

Using the Equalizer to Enhance your Audio

After adjusting the audio levels of your audio clips in your project, you may find that the audio needs further finessing. In some cases you may find that the dialogue, music and sound effects are competing for the same frequency on the audio spectrum, making your audio too busy and unclear. This is where using EQ can help, as it allows you to specify the parts of the audio spectrum that each track occupies. You can also use an equalizer to help remove unwanted elements from your audio by isolating and reducing the level on particular frequencies that contain low rumbles, hums, wind noise and hiss, or simply to improve the overall quality of your sound so it is more pleasing to listen to.

DaVinci Resolve provides EQ filters that can be applied at a clip level to each individual clip or at the track level to affect entire tracks. Each audio clip in the timeline has a four band equalizer in the inspector panel, and each track has a 6 band parametric equalizer in the mixer panel. The graphical and numeric controls for boosting or attenuating different ranges of frequencies, and different filter types allow you to define the shape of the EQ curve.



The four band equalizer can be applied to every clip in the timeline

Outer bands let you make band filter adjustments using hi-shelf, lo-shelf, hi-pass and lo-pass filters. A pass filter affects all the frequencies above or below a particular frequency, by removing those frequencies completely from the signal. For example, a high pass filter will allow the high frequencies to pass through the filter while cutting the low frequencies. Any frequencies outside the cutoff frequency are cut gradually in a downward sloping curve.

A shelf filter is less aggressive, and is useful when you want to shape the overall top end or low end of the signal without completely removing those frequencies. The shelf filter boosts or cuts the target frequency and every frequency either above or below it evenly, depending on whether you use a high shelf or low shelf.

The middle sets of band controls let you make a wide variety of equalization adjustments, and can be switched between lo-shelf, bell, notch, and hi-shelf filtering options.

- **Bell:** Bell filters boost or cut frequencies around a given center point of the bell curve, and as the name suggests the shape of the curve is like a bell.
- **Notch:** Notch filters allow you to specifically target a very narrow range of frequencies. For example, removing a mains hum at 50 or 60Hz.
- **Lo-Shelf:** Low shelf filters boost or cut the target frequency at the low end, and every frequency below it

- **Hi-Shelf:** High shelf filters boost or cut the target frequency at the high end, and every frequency above it

To add EQ to an individual clip:

- 1 Select the clip in the timeline that you want to add the EQ filter to.
- 2 Click on the inspector and then click the 'clip equalizer' enable button.

To add EQ to a track:

- 1 Double click in the EQ section for one of your tracks in the mixer to open the equalizer for that track.
- 2 Select the band filter type from the dropdown menu for the band you want to adjust.



The EQ section in the mixer panel indicating an EQ curve has been applied to track one



The 6 Band parametric equalizer that can be applied to every track

Once you have added EQ to your clip or track, you can adjust the EQ for each band. Note that controls may vary depending on which band filter type is selected.

To adjust the EQ for a band filter:

- 1 Select the band filter type from the dropdown menu for the band you want to adjust.
- 2 Adjust the 'frequency' value to select the center frequency of the EQ adjustment.
- 3 Adjust the 'gain' value to boost or attenuate the frequencies governed by that band.
- 4 Use the 'Q factor' value to adjust the width of affected frequencies.

Use the reset button to reset all controls in the EQ window to their defaults.

Fairlight has many controls you can use to improve the quality of each audio track. You can add more tracks and arrange buses to organize them, plus add effects like delay or reverb, and generally perfect your audio mix.

Adding VFX and Compositing on the Fusion Page

Now that you have completed your edit, you can open the Fusion page to add 2D or 3D visual effects and motion graphics right within DaVinci Resolve. Unlike layer based compositing software, Fusion uses nodes, giving you the freedom to build complex effects while routing image data in any direction. The nodes window clearly shows every tool used along the way. If you have experienced the node workflow in the color page, this will feel familiar to you.

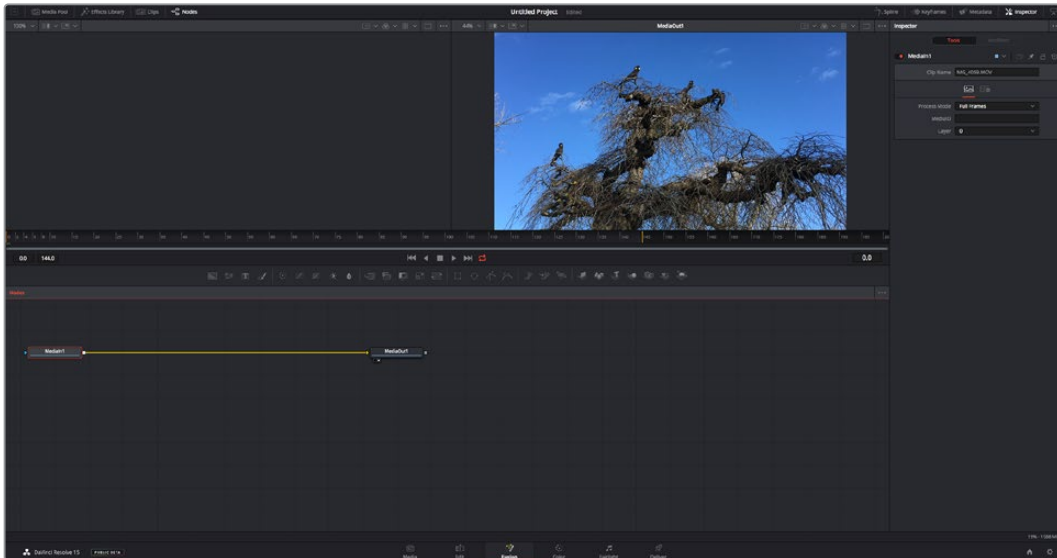

The Fusion Page

The Fusion page features 2 viewer windows across the top with transport controls to view your media, an inspector window to the right to access tool settings, and a nodes window at the bottom where you build your composition. While the viewers and transport controls are always visible, clicking on the icons on the interface toolbar at the very top of the display will let you show or hide the nodes and inspector windows, or reveal or hide additional windows including the effects library and editors for spline and keyframes.

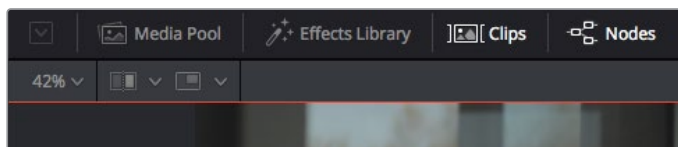

- **Media Pool:** The media pool functions the same way as it appears in the edit page. Simply drag additional media from your bins directly to your composition.
- **Effects Library:** The effects library is where you will find your Fusion tools and templates sorted into categories including particle, tracking, filters and generators. You can either click on the tool or drag it to the nodes area to add it to your composition. The media pool and effects library take up the same screen area, so you can swap between the two to keep your viewers as large as possible.
- **Clips:** Clicking the clips tab will reveal or hide thumbnails representing clips on your timeline. The thumbnails are located underneath the nodes editor, letting you instantly navigate to other clips.

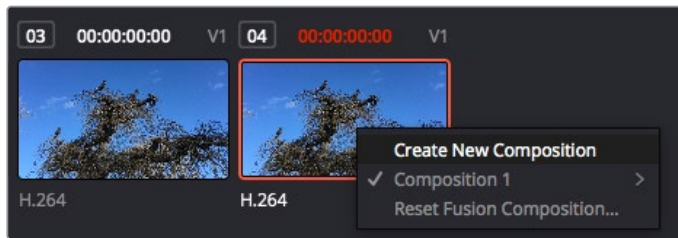

Create a new version of your composition by right clicking on a thumbnail and selecting 'create new composition'.

- **Viewers:** The viewers are always visible and let you see the different views of your composition, for example an overall 3D perspective via the merge 3D node, a camera output, or your final render output. These viewers also let you see how your changes are affecting a specific element.

You can choose which nodes to view by clicking on a node and typing '1' for the left viewer or '2' for the right viewer. White button icons appear beneath the node to let you know which viewer it is assigned to. If you're using external video monitoring, there will be a third button available to route your media to your external video monitor.

TIP You can also assign a node to a viewer by dragging the node into the viewer itself.

The transport controls underneath the viewers let you skip to the start or end of the clip, play forward or reverse, or stop playback. The time ruler displays the entire range of a clip, with yellow marks indicating the in and out points.

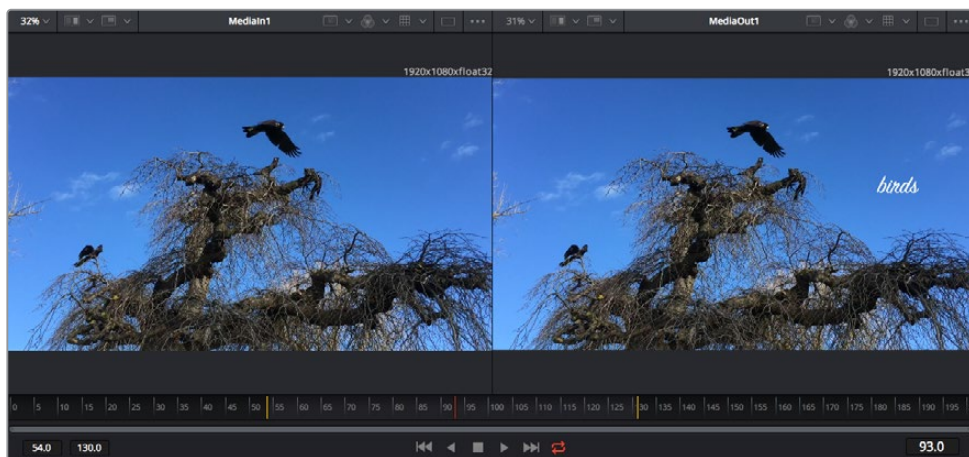

The yellow marks on the time ruler indicate your clip's in and out points on your timeline. If you are using a Fusion clip or compound clip, the time ruler will only show you the duration of the clip as it appears on the timeline, without handles.

- **Nodes:** The nodes window is the heart of the Fusion page where you build your node tree by connecting tools together from one node's output to another node's input. This area will change size depending on which editors are open, for example the spline or keyframes editor. A toolbar at the top of the nodes area features the most commonly used tools for fast access.

- **Spline:** When the spline editor is open, it will appear to the right of the nodes window. This editor lets you make precise adjustments to each node, such as smoothing the animation between two keyframes using bezier curves.
- **Keyframes:** Keyframes for each tool can be added, removed or modified using the keyframes editor. This also appears to the right of the nodes viewer.
- **Metadata:** The metadata window will show you metadata available for the active clip, including the codec, frame rate and timecode.
- **Inspector:** The inspector in the top right corner displays all settings and modifiers available for one or more selected nodes. Additional tab options will appear to provide quick access to other settings for nodes sorted by category.

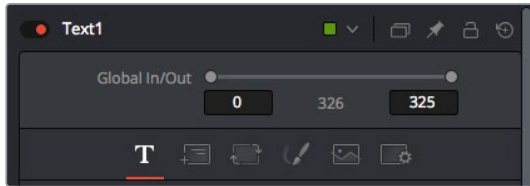

The text inspector contains additional tabs for text, layout, transform, shading, image and settings.

Getting Started with Fusion

To get started with Fusion, simply position your playhead over any clip on your timeline and click on the 'Fusion' tab to open the Fusion page.

On the Fusion page, your clip is immediately available in a media input node labelled 'MediaIn'. Every composition will begin with a 'mediain' and a 'mediaout' node. This mediain node represents the top most clip of your timeline at the playhead, and ignores any clips underneath. Any adjustments you've applied to the clip on the edit page, such as transform tools and cropping changes, are also included.

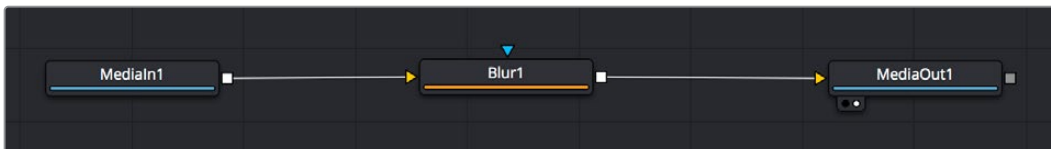

The media output node, named 'MediaOut', is the node that sends the output back to your timeline on DaVinci Resolve's edit page.

TIP ResolveFX or OFX plug-ins applied to clips in the edit page are not applied in the Fusion page. This is because Fusion effects occur prior to color correction and OFX/ResolveFX processing. If you want OFX applied before Fusion effects, right click the clip in the edit page and select 'new fusion clip' before clicking on the Fusion page.

Understanding Nodes

It can be helpful to think of each node as a visual icon representing a single tool or effect. Nodes are connected to other nodes to build the overall composition, much like ingredients in a cake. It's important to understand the inputs and outputs of each node as this will help you navigate the flow of your composition while building detailed visual effects.

Some tools have multiple inputs and outputs you can connect to other nodes. The merge node, for example, lets you attach a foreground input, background input, and a mask input for mattes or keys.

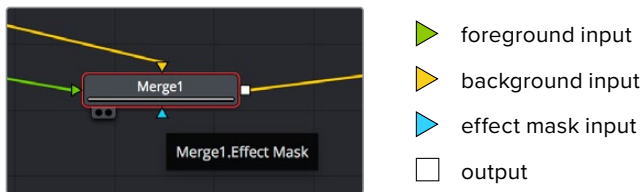

Multiple outputs on nodes means a single node can connect to many different nodes in your composition, so you don't have to duplicate clips as you would in layer based software. Arrows on the line between connected nodes are a great visual indicator to show you which direction the image data is flowing.

Adding Nodes to the Node Editor

Adding effects is as simple as placing nodes on the line between the 'mediain' and 'mediaout' nodes.

There are a few ways you can do this. You can hold down the shift button and drop a node between two nodes, or click on the node you want to attach an effect to and select the tool you want to add. The new node will automatically connect to the tool selected. You can also add a node anywhere on the node window and manually connect nodes by dragging the output of one to the input on another.

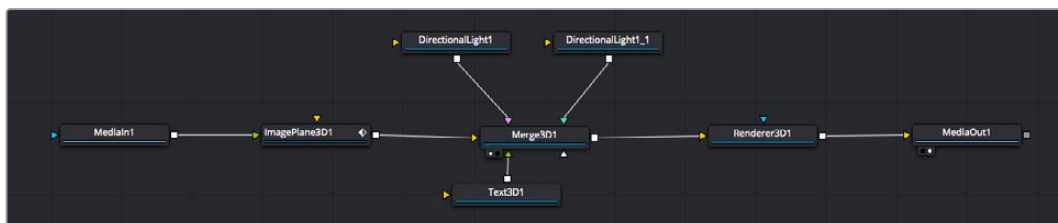

The most commonly used tool is the 2D or 3D merge node. This node is like a central hub that combines tools on the node editor into a single output.

The merge node has controls for how the inputs are managed, including settings for size, position, and blend. These settings are all accessible in the inspector panel when the merge node is selected.

The toolbar above the node panel contains the most commonly used tools as icons that you can either click on to add the node, or drag the tool to the node panel. If you want to see all the complete tools available, click on the 'effects library' in the top left corner and expand the 'tools' option. Here you'll find all the tools sorted by category, as well as a set of pre-built 'templates' you can use, for example lens flares, shaders and backgrounds.

TIP Once you're familiar with the tool names, you can hold down 'shift' and press 'spacebar' on your keyboard and a 'select tools' menu will appear. As you type the tool name, the menu will suggest the relevant tool. This is a very fast way to select the tool you want.

Adjusting Nodes Using the Inspector Panel

Adjust your node settings using the inspector panel. Simply click on the node you want to modify and the panel will update to display its settings and controls.

With Fusion, you don't have to be viewing the node you're editing, as you can modify one node while viewing another in your composition. For example, you can modify the size and center position of a 'text+' node while the merge node is in the viewer, letting you view the text relative to the background.

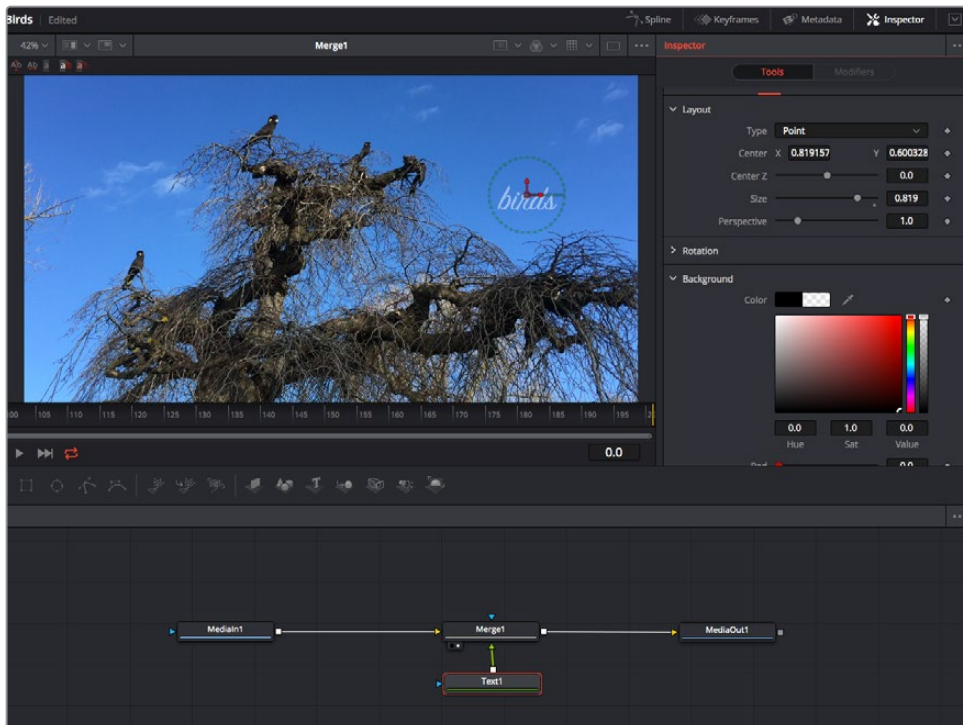

Selected nodes appear with a red border. Here the inspector panel is displaying the layout tab controls for the text node.

There are different parameters and settings you can adjust for every node depending on its task, from sizing and center positions to changing the number of particles in an emitter node. Setting keyframes and changing the settings over time will animate the effect.

Working with Keyframes

In the inspector window, set a keyframe by right clicking on a setting and choosing 'animate' from the contextual menu. The keyframe icon to the right of the setting will turn red. This means keyframes are now active and any changes you make will be applied to the current frame only. When two or more keyframes are created by changing the setting parameters on a different frame, a transition is interpolated between them. Arrows on each side of the keyframe icon let you move the playhead to those exact positions on the timeline.

The splines panel gives you further control over keyframe animation. You can select keyframes, such as the first and last, and smooth the animation between them into a bezier curve by typing 'shift' + 's', or right clicking on a keyframe and selecting 'smooth'.

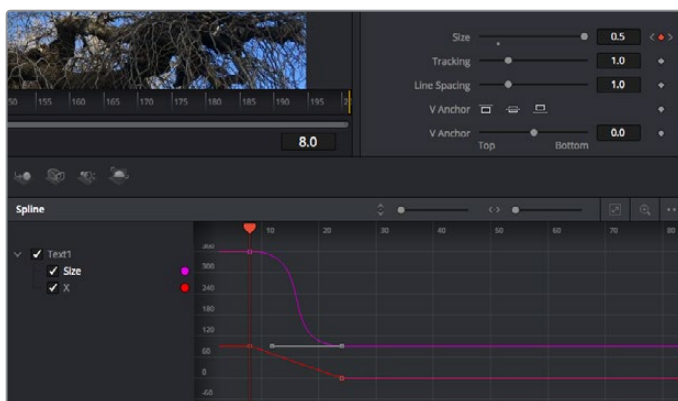

Here, the 'size' keyframe animation has been smoothed into a bezier curve. You can click the bezier handles to shorten or lengthen the curve, or the keyframe square icons to move the keyframe location.

Using the Motion Tracker and Adding Text

To get a better idea of how to use Fusion, we have included the following examples to show how to use the tracker tool to track an element in a clip, plus add text and attach it to the element using the tracking data.

The 'tracker' tool tracks pixels over time on the x & y axis, and generates data you can use to attach other elements. This is great for when you want to match the position of text to a moving object, such as a car driving along the road, or a bird as it flies across frame.

- 1 In the 'effects library', select the 'tracking' tool and drag it to the line between the 'mediain' and the 'mediaout' nodes. Now click the tracker node to reveal its properties in the inspector.
- 2 Type '1' on your keyboard to see the 'tracker' node on the left viewer. The clip will appear in the viewer together with the tracker at its default position. Hover your mouse pointer over the tracker to reveal the tracker handle. Click on the tracker handle at the top left corner and drag the tracker to an area of interest on your clip. High contrast areas work well, for example the badge on the hood of a car. The tracker will magnify the image area for extra precision.
- 3 In the inspector window, click on the 'track forward' button to start tracking. A notification window will appear when the tracking is done. Click OK.

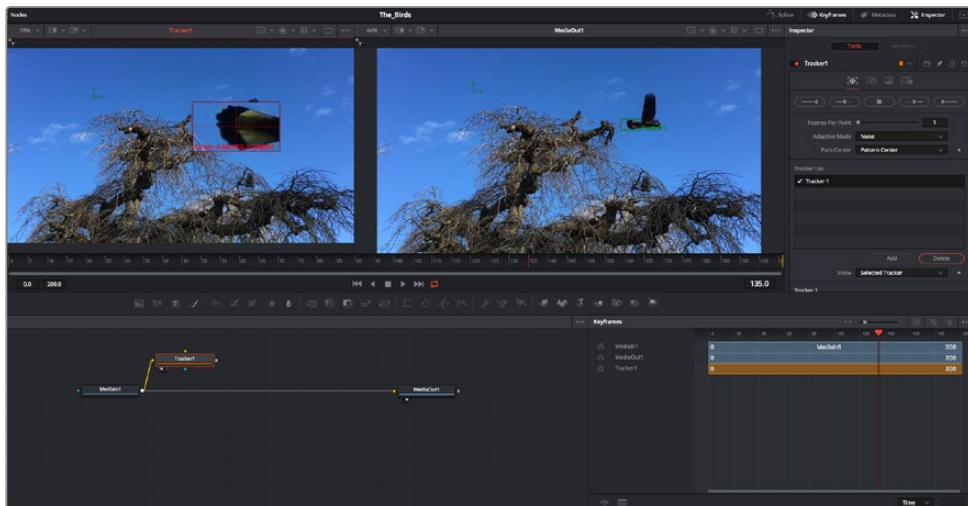

Tracking options in the inspector panel include track reverse from last frame or current frame, stop track or track forward from current frame or first frame.

TIP Track reverse or forward from current frame is great for situations where your area of interest disappears during the render range, such as a car or bird moving out of frame. This lets you track only the relevant footage.

Now you can take that tracking data and apply the motion path to a text tool.

- 4 Click on the 'text+' node icon from the toolbar of commonly used nodes and drag it to the node panel near the 'tracker' node. Connect the 'text' output square to the green foreground input on the 'tracker'.

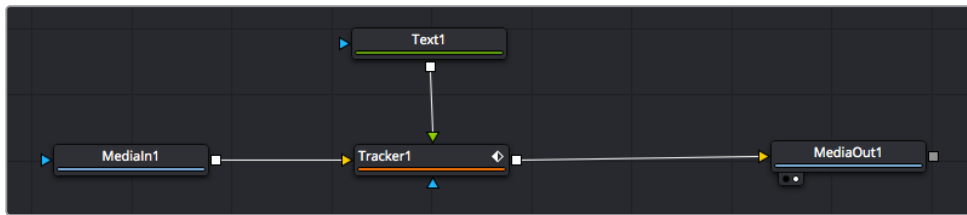

- 5 Click on the 'tracker' node and type '1' so you can see the merged results on your left hand viewer. In the 'tracker' inspector panel, click on the 'operations' tab. You can see the tab's name by hovering the mouse pointer over it. Click the dropdown menu next to operation and select 'match move'.
- 6 Click the 'text' node to reveal the properties in the inspector. Type your text into the text box and change the font, color and size to suit your composition.

This will apply the tracking position data from your tracker to your text. If you want to change the text offset, click on the 'trackers' tab back in the inspector panel and use the x and y offset scroll wheels to modify the position.

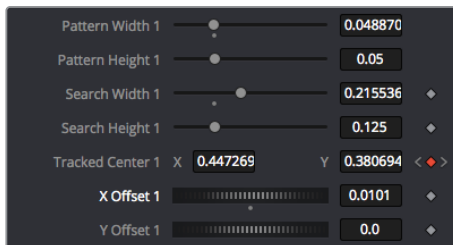

Scroll wheels at the bottom of the tracker inspector panel let you adjust the offset position for the text.

Now you can play back your composition and see your text attached to the object you have tracked!

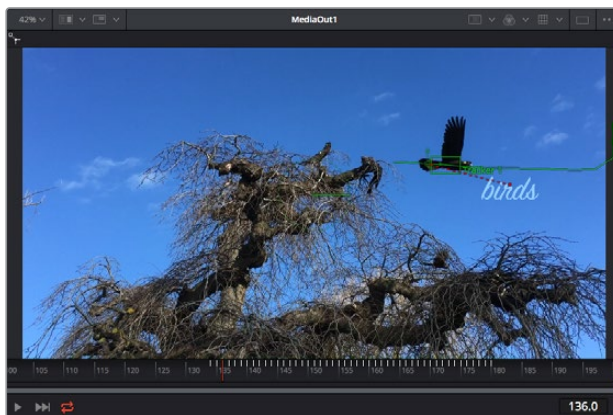

The green square is the tracker's current position along the green path, and the red dashed line is the offset position used to animate the text.

For some shots you might want to remove track points after tracking, such as when the object you are tracking disappears off the screen. The keyframe editor makes this a very simple process.

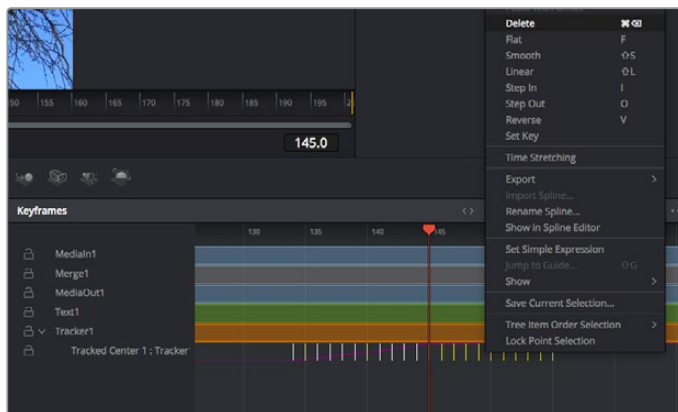

- 7 Click on the keyframes tab above the inspector to open the keyframes editor. Any nodes with keyframes applied will have a small arrow next to the node label, and only the parameter with keyframes added will appear in the list below. Click on the magnify icon and drag a box around the area you want to edit. This will zoom into that area so you can see the keyframes easier.
- 8 Move the playhead to the location of the last keyframe you want. Now select the keyframes you wish to remove by drawing a box around them with your mouse. The keyframes will highlight yellow. Right click and choose delete from the menu.

TIP If your effects are particularly system intensive, right clicking on the transport controls area will give you viewer options, including proxy playback, helping you get the most out of your system while you build your composition. Refer to the DaVinci Resolve manual for further detail on all the playback options.

You have now completed your first composition animating text to match a movement in your footage!

If you want to track an area of the image that contains a flat surface you want to enhance or replace, you can use the planar tracker. Tracking 2D planes can be helpful for changing labels and signs in a moving image, or even adding an image to a monitor or TV in your shot.

For more information about the planar tracker and the many powerful tools in the DaVinci Resolve Fusion page, see the DaVinci Resolve manual.

TIP As you build visual effects in the Fusion page, it's worth noting if the effect you are building is a 2D effect, or a 3D effect, as this will determine which merge tool is used. You may discover yourself frequently combining 2D and 3D effects in the one composite. In this scenario, it's helpful to remember that any visual effect using the 3D space needs to be rendered as a 2D image before it can be merged into a 2D composite.

We believe you will have lots of fun with Fusion and exploring Fusion's visual effects with the power of DaVinci Resolve's edit, color, and Fairlight pages. With all these tools at your finger tips, DaVinci Resolve is incredibly powerful and there is really no limit to what you can create!

Mastering Your Edit

Now you've edited, graded, added vfx and mixed your audio, you'll want to share it with others. You can use the Quick Export button, or menu selection, to output the contents of the Timeline as a self contained file in one of a variety of different formats, or use the additional features of the 'deliver' page.



The 'deliver' page is where you export your edit. You can select from many different video formats and codecs

Quick Export

You can choose File > Quick Export to use one of a variety of export presets to export your program from any page of DaVinci Resolve. You can even use quick export to export and upload your program to one of the supported video sharing services, including YouTube, Vimeo, and Frame.io.

To use Quick Export:

- 1 In the 'edit', 'fusion', or 'color' page, optionally set in and out points in the timeline to choose a range of the current program to export. If no timeline in or out points have been set, the entire timeline will be exported.
- 2 Choose File > Quick Export.
- 3 Select a preset to use from the top row of icons in the quick export dialog, and click 'export'.
- 4 Choose a directory location and enter a file name using the export dialog, then click 'save'. A progress bar dialog appears to let you know how long the export will take.

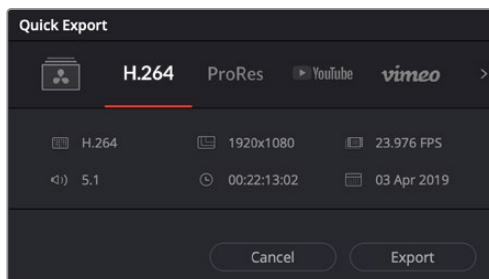

The quick export dialog

The Deliver Page

This page lets you select the range of clips you want to export, plus the format, codec and resolution you want. You can export in many types of formats such as QuickTime, AVI, MXF and DPX using codecs such as 8-bit or 10-bit uncompressed RGB/YUV, ProRes, DNxHD, H.264 and more.

To export a single clip of your edit:

- 1 Click on the 'deliver' tab to open the deliver page.
- 2 Go to the 'render settings' window on the top left of the page. Choose from a number of export presets, for example YouTube, Vimeo and audio presets, or you can set your own export settings manually by leaving it set to the default 'custom' preset and entering your own parameters. For this example, select YouTube, then click on the arrow next to the preset and select the 1080p video format.

The frame rate will be locked to your project frame rate setting.
- 3 Underneath the presets you will see the timeline filename and the target location for your exported video. Click the 'browse' button and choose the location where you want to save your exported file and then select 'single clip' from the render option.
- 4 Immediately above the timeline, you'll see an options box with 'entire timeline' selected. This will export the entire timeline, however you can select a range of the timeline if you want to. Simply choose 'in/out range' and then use the 'i' and 'o' hot key shortcuts to choose the in and out points in your timeline.
- 5 Go to the bottom of the 'render settings' and click on the 'add to render queue' button.

Your render settings will be added to the render queue on the right side of the page. Now all you have to do is click 'start render' and monitor the progress of your render in the render queue.

When your render is complete you can open the folder location, double click on your new rendered clip and watch your finished edit.

Now that you have a basic knowledge of how to edit, color, mix audio and add visual effects, we recommend experimenting with DaVinci Resolve. Refer to the DaVinci Resolve manual for more details on how each feature can help you make the most of your project!

Post Production Workflow

Working with 3rd Party Software

If you have your own favorite editing software you'd like to use, you can easily copy your clips to an internal/external drive or RAID and then import your clips into the software.

If you want to, you can even edit your clips directly from the SD card.

Using Final Cut Pro X

To edit your clips using Final Cut Pro X, you need to create a new project and set a suitable video format and frame rate. This example uses ProRes 422 HQ 1080p24.

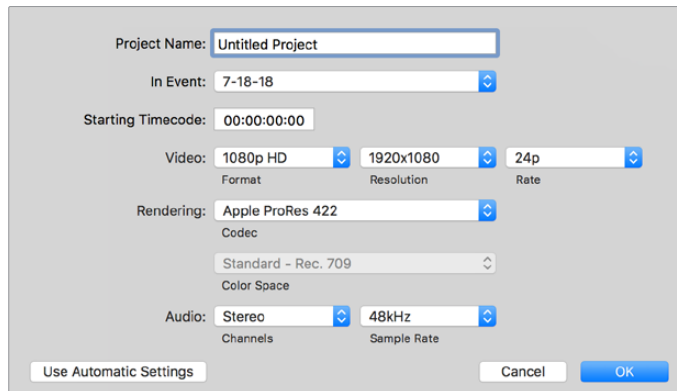

Final Cut Pro X project settings

- 1 Launch Final Cut Pro X, go to the 'menu' bar and select 'file/new project'. A window will open containing project settings.
- 2 Name your project and select the 'custom' checkbox.
- 3 Set the 'video properties' settings to 1080p HD, 1920x1080 and 24p.
- 4 Set your 'audio' and 'render properties' settings to 'stereo, 48kHz, and Apple ProRes 422 HQ'
- 5 Click OK.

To import your clips into your project, go to the 'menu' bar and select 'file/import/media'. Choose your clips from your hard drive.

You can now drag your clips onto the timeline for editing.

Using Avid Media Composer 2018

To edit your clips using Avid Media Composer 2018, create a new project and set a suitable video format and frame rate. For this example, clips are set using 1080p24.

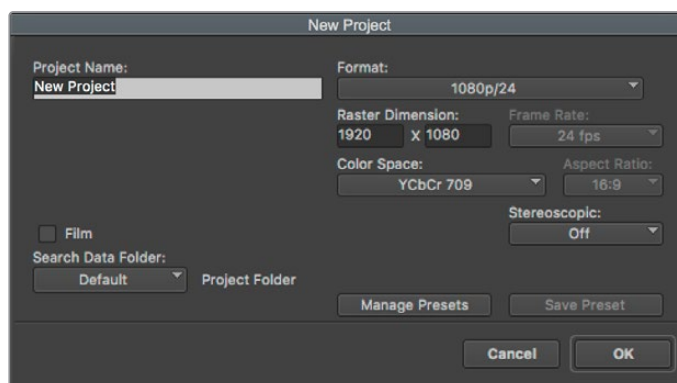

Setting the project name and project options in Avid Media Composer 2018

- 1 Launch Avid Media Composer 2018 and the 'select project' window will appear.
- 2 Click the 'new project' button and name your project in the 'new project' window.
- 3 In the 'format' drop down menu select HD 1080 > 1080p/24 and click 'ok' to create the project.
- 4 Double click the project in the 'select project' window to open it.
- 5 Select file > input > source browser and navigate to the files you wish to import.
- 6 Select your 'target bin' from the drop down menu and click 'import'.

When the clips appear within the media bin you can drag your clips onto the timeline and begin editing.

Using Adobe Premiere Pro CC

To edit your Apple ProRes 422 HQ clips using Adobe Premiere Pro CC, you need to create a new project and set a suitable video format and frame rate. For this example, clips are set using ProRes 422 HQ 1080p25.

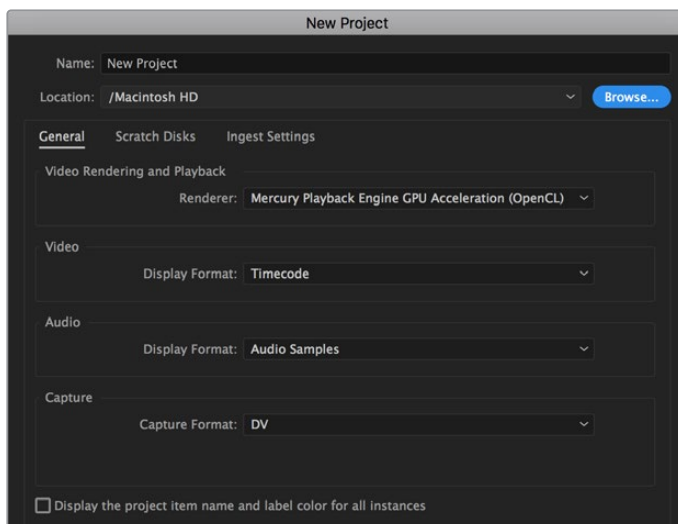

Setting the project name and project options in Adobe Premiere Pro CC

- 1 Launch Adobe Premiere Pro CC. In the 'welcome' window select 'new project'. A window will open containing project settings.
- 2 Name your project. Choose the location for your project by clicking 'browse' and selecting your desired folder. Once you've selected your location folder click OK in the 'new project' window.
- 3 Go to the Adobe Premiere Pro CC 'menu' bar, select 'file/import' and choose the clips you want to edit. Your clips will appear in the project window.
- 4 Drag the first clip you wish to edit onto the 'new item' icon at the bottom right of the project window. A new sequence will be created matching your clip settings.

You can now drag your clips onto the sequence timeline for editing.

Help

Getting Help

The fastest way to obtain help is to go to the Blackmagic Design online support pages and check the latest support material available for your video assist.

Blackmagic Design Online Support Pages

The latest manual, software and support notes can be found at the Blackmagic Design support center at www.blackmagicdesign.com/support.

Blackmagic Design Forum

The Blackmagic Design forum on our website is a helpful resource you can visit for more information and creative ideas. This can also be a faster way of getting help as there may already be answers you can find from other experienced users and Blackmagic Design staff which will keep you moving forward. You can visit the forum at <https://forum.blackmagicdesign.com>

Contacting Blackmagic Design Support

If you can't find the help you need in our support material or on the forum, please use the "Send us an email" button on the support page to email a support request. Alternatively, click on the "Find your local support team" button on the support page and call your nearest Blackmagic Design support office.

Checking the Software Version Currently Installed

To check which version of Blackmagic Video Assist software is installed on your computer, open the About Blackmagic Video Assist Setup window.

- On macOS, open Blackmagic Video Assist Setup from the Applications folder. Select About Blackmagic Video Assist Setup from the application menu to reveal the version number.
- On Windows 8, open Blackmagic Video Assist Setup from the Blackmagic Video Assist Setup tile on your Start page. Click on the Help menu and select About Blackmagic Video Assist Setup to reveal the version number.
- In Windows 8.1, select the down arrow icon from the 'start' screen, and scroll down to the Blackmagic Design folder. From here you can launch Blackmagic Video Assist Setup.
- In Windows 10, click the start button and select 'all apps'. Scroll down to the Blackmagic design folder. From here you can launch Blackmagic Video Assist Setup.

How to Get the Latest Software Updates

After checking the version of Blackmagic Video Assist Setup software installed on your computer, please visit the Blackmagic Design support center at www.blackmagicdesign.com/support to check for the latest updates.

While it is usually a good idea to run the latest updates, it is wise to avoid updating any software if you are in the middle of an important project.

Regulatory Notices

Disposal of Waste of Electrical and Electronic Equipment Within the European Union.



The symbol on the product indicates that this equipment must not be disposed of with other waste materials. In order to dispose of your waste equipment, it must be handed over to a designated collection point for recycling. The separate collection and recycling of your waste equipment at the time of disposal will help conserve natural resources and ensure that it is recycled in a manner that protects human health and the environment. For more information about where you can drop off your waste equipment for recycling, please contact your local city recycling office or the dealer from whom you purchased the product.



This equipment has been tested and found to comply with the limits for a Class A digital device, pursuant to Part 15 of the FCC rules. These limits are designed to provide reasonable protection against harmful interference when the equipment is operated in a commercial environment. This equipment generates, uses, and can radiate radio frequency energy and, if not installed and used in accordance with the instructions, may cause harmful interference to radio communications. Operation of this product in a residential area is likely to cause harmful interference, in which case the user will be required to correct the interference at personal expense.

Operation is subject to the following two conditions:

- 1 This device may not cause harmful interference.
- 2 This device must accept any interference received, including interference that may cause undesired operation.

–



R-R-BMD-20200131001
R-R-BMD-20200131002
R-R-BMD-201907002
R-R-BMD-201907003

ISED Canada Statement

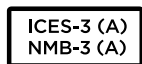

This device complies with Canadian standards for Class A digital apparatus.

Any modifications or use of this product outside its intended use could void compliance to these standards.

Connection to HDMI interfaces must be made with high quality shielded HDMI cables.

This equipment has been tested for compliance with the intended use in a commercial environment. If the equipment is used in a domestic environment, it may cause radio interference.

Safety Information

Product is suitable for use in tropical locations with an ambient temperature of up to 40°C.

Ensure that adequate ventilation is provided around the product and that it is not restricted.

No operator serviceable parts inside product. Refer servicing to your local Blackmagic Design service center.

During sunny conditions, consider shading of the unit to prevent exposure of the lithium battery to extended periods of sunlight. Keep lithium batteries away from all sources of heat.

State of California statement

This product can expose you to chemicals such as trace amounts of polybrominated biphenyls within plastic parts, which is known to the state of California to cause cancer and birth defects or other reproductive harm.

For more information go to www.P65Warnings.ca.gov.

Singapore Notice

The power adapter supplied with your Blackmagic Design equipment has interchangeable plugs to suit the mains socket outlets in a number of countries. Each plug marked with the model numbers APD2-UK or APD2-EU are approved and suitable for use in Singapore.

Warranty

12 Month Limited Warranty

Blackmagic Design warrants that this product will be free from defects in materials and workmanship for a period of 12 months from the date of purchase. If a product proves to be defective during this warranty period, Blackmagic Design, at its option, either will repair the defective product without charge for parts and labor, or will provide a replacement in exchange for the defective product.

In order to obtain service under this warranty, you the Customer, must notify Blackmagic Design of the defect before the expiration of the warranty period and make suitable arrangements for the performance of service. The Customer shall be responsible for packaging and shipping the defective product to a designated service center nominated by Blackmagic Design, with shipping charges pre paid. Customer shall be responsible for paying all shipping charges, insurance, duties, taxes, and any other charges for products returned to us for any reason.

This warranty shall not apply to any defect, failure or damage caused by improper use or improper or inadequate maintenance and care. Blackmagic Design shall not be obligated to furnish service under this warranty: a) to repair damage resulting from attempts by personnel other than Blackmagic Design representatives to install, repair or service the product, b) to repair damage resulting from improper use or connection to incompatible equipment, c) to repair any damage or malfunction caused by the use of non Blackmagic Design parts or supplies, or d) to service a product that has been modified or integrated with other products when the effect of such a modification or integration increases the time or difficulty of servicing the product.

THIS WARRANTY IS GIVEN BY BLACKMAGIC DESIGN IN LIEU OF ANY OTHER WARRANTIES, EXPRESS OR IMPLIED. BLACKMAGIC DESIGN AND ITS VENDORS DISCLAIM ANY IMPLIED WARRANTIES OF MERCHANTABILITY OR FITNESS FOR A PARTICULAR PURPOSE. BLACKMAGIC DESIGN'S RESPONSIBILITY TO REPAIR OR REPLACE DEFECTIVE PRODUCTS IS THE WHOLE AND EXCLUSIVE REMEDY PROVIDED TO THE CUSTOMER FOR ANY INDIRECT, SPECIAL, INCIDENTAL OR CONSEQUENTIAL DAMAGES IRRESPECTIVE OF WHETHER BLACKMAGIC DESIGN OR THE VENDOR HAS ADVANCE NOTICE OF THE POSSIBILITY OF SUCH DAMAGES. BLACKMAGIC DESIGN IS NOT LIABLE FOR ANY ILLEGAL USE OF EQUIPMENT BY CUSTOMER. BLACKMAGIC IS NOT LIABLE FOR ANY DAMAGES RESULTING FROM USE OF THIS PRODUCT. USER OPERATES THIS PRODUCT AT OWN RISK.

© Copyright 2021 Blackmagic Design. All rights reserved. 'Blackmagic Design', 'DeckLink', 'HDLink', 'Workgroup Videohub', 'Multibridge Pro', 'Multibridge Extreme', 'Intensity' and 'Leading the creative video revolution' are registered trademarks in the US and other countries. All other company and product names may be trade marks of their respective companies with which they are associated.