

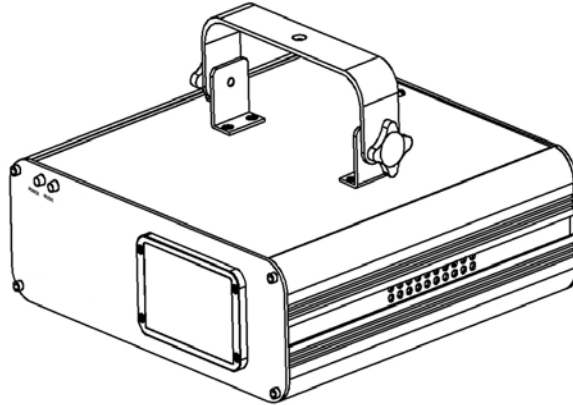

51302 - GALACTIC RGY110



Version: 2.0

This manual contains important laser system safety and operation information. Read and understand all instructions prior to powering on laser unit the first time, to avoid laser eye injury and to avoid breaking the law. Keep this manual in a safe place for future reference.

WARNING DATA

Lasers can be hazardous and have unique safety considerations. Permanent eye injury and blindness is possible if lasers are used incorrectly. Pay close attention to each safety REMARK and WARNING statement in the user manual. Read all instructions carefully BEFORE operating this device.



Attention! Indicates a skill or other useful information for special situations.



Important! Indicates important information to protect personnel from laser incident or injury.



Caution! Prevent damage or injury from incorrect operation.



Laser! Laser safety warning labels.



Recycle To protect the environment, recycle packing material wherever possible.



Indoor The projector is for indoor use only, IP20. Use only in dry locations. Keep this device away from rain and moisture, excessive heat, humidity and dust. Do not allow contact with water or other fluids.









Disposal Don't throw this product away just as general trash, please dispose of this product following the abandon electronic product regulations in your area.



Location The projector must be installed in a location with adequate ventilation, at least 50cm (20 inches) from adjacent surfaces. Be sure that no ventilation slots are blocked.

LASER SAFETY WARNINGS

Potential laser injury hazard exists with this product! Read these instructions carefully, which includes important information about installation, safe use and service!

-  **Caution** Avoid direct eye contact with laser light. Never intentionally expose your eyes or others to direct laser light.
-  **Caution** This laser product can potentially cause instant eye injury or blindness if laser light directly strikes the eyes.
-  **Caution** It is illegal and dangerous to shine this laser into audience areas, where the audience or other personnel could get direct laser beams or bright reflections into their eyes.
-  **Caution** It is a US Federal offense to shine any laser at aircraft.
-  **Caution** There are no user serviceable parts inside the unit. Do not open the housing or attempt any repairs yourself. In the unlikely event your unit may require service, please contact the dealer nearest to you..
-  **Caution** Use of controls or adjustments or performance of procedures other than those specified herein may result in hazardous radiation exposure

NON-INTERLOCKED HOUSING WARNING

This unit contains high power laser devices internally. Do not open the laser housing, due to potential exposure to unsafe levels of laser radiation. The laser power levels accessible if the unit is opened can cause instant blindness, skin burns and fires.

LASER SAFETY AND OPERATING INSTRUCTIONS



STOP AND READ ALL LASER SAFETY DATA



Laser Light is different from any other light source with which you may be familiar. The light from this product can potentially cause eye injury if not set up and used properly.

Laser light is thousands of times more concentrated than light from any other kind of light source. This concentration of light power can cause instant eye injuries, primarily by burning the retina (the light sensitive portion at the back of the eye). Even if you cannot feel “heat” from a laser beam, it can still potentially injure or blind you or your audience. Even very small amounts of laser light are potentially hazardous even at long distances. Laser eye injuries can happen quicker than you can blink.

It is incorrect to think that because these laser entertainment products split the laser into hundreds of beams or laser beam is scanned out in high speed, that an individual laser beam is safe for eye exposure. This laser product uses dozens of milliwatt of laser power (Class 3B levels internally). Many of the individual beams are potentially hazardous to the eyes.

It is also incorrect to assume that because the laser light is moving, it is safe. This is not true. Nor, do the laser beams always move. Since eye injuries can occur instantly, it is critical to prevent the possibility of any direct eye exposure. In the laser safety regulation, it is not legal to aim Class 3B lasers in areas which people can get exposed. This is true even if it is aimed below people’s faces, such as on a dance floor.

- Do not operate laser without first reading and understanding all safety and technical data in this manual
- Always set up and install all laser effects so that all laser light is at least 3 meters (9.8 feet) above the floor on which people can stand. See “Proper Laser Set-up & Usage” section later in this manual
- After set up, and prior to public use test laser to ensure proper function. Do not use if any defect is detected. Do not use if laser emits only one or two laser beams rather than dozens/hundreds, as this could indicate damage to the diffraction grating optic, and could allow emission of higher laser levels.

- Do not point lasers at people or animals
- Never look into the laser aperture or laser beams
- Do not point lasers in areas in which people can potentially get exposed, such as uncontrolled balconies, etc.
- Do not point lasers at highly reflective surfaces such as windows, mirrors and shiny metal. Even laser reflections can be hazardous.
- Never point a laser at aircraft, this is a federal offense
- Never point un-terminated laser beams into the sky
- Do not expose the output optic (aperture) to cleaning chemicals
- Do not use laser if the laser appears to be emitting only one or two beams
- Do not use laser if housing is damaged or open, or if optics appear damaged in any way.
- Never open the laser housing. The high laser power levels inside of the protective housing can start fires, burn skin and will cause instant eye injury.
- Never leave this device running unattended.
- The operation of a class 3B laser show laser is only allowed if the show is controlled by a skilled and well-trained operator familiar with the data included in this manual.
- The legal requirements for using laser entertainment products vary from country to country. The user is responsible for the legal requirements at the location/country of use.
- Always use appropriate lighting safety cables when hanging lights and effects overhead

LASER SAFETY LABEL REPRODUCTIONS

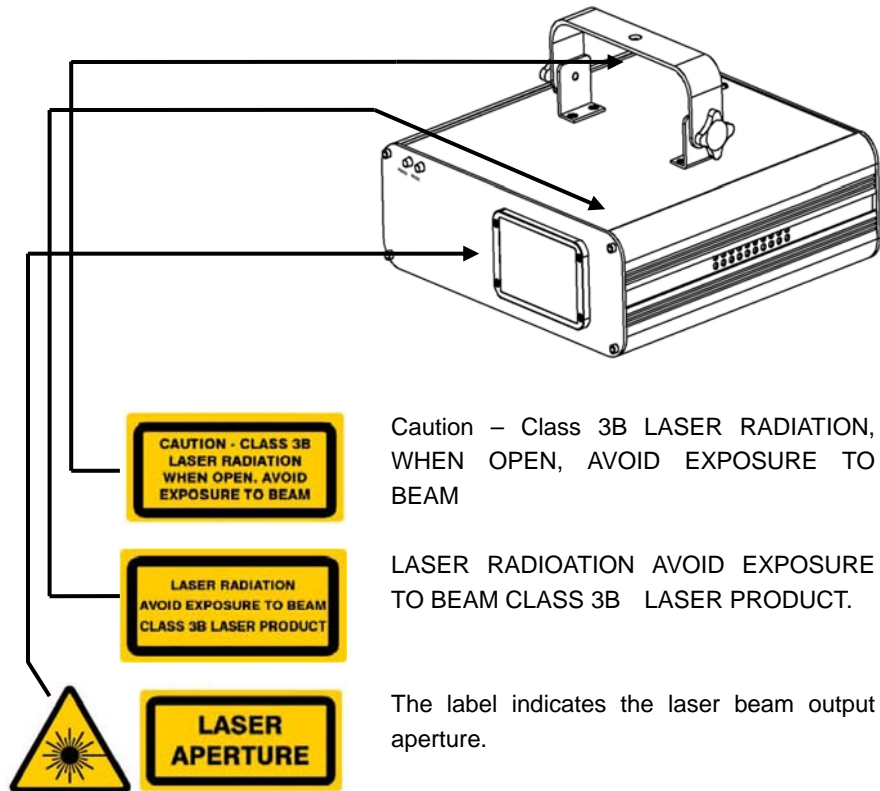

LASER EXPOSURE WARNING



**LASER LIGHT
AVOID DIRECT EYE EXPOSURE**

Further guidelines and safety programs for safe use of lasers can be found in the ANSI Z136.1 Standard "For Safe Use of Lasers", available from "www.laserinstitute.org". Many local governments, corporations, agencies, military and others, require all lasers to be used under the guidelines of ANSI Z136.1. Laser Display guidance can be obtained via the International Laser Display Association, www.laserist.org.

LASER EMISSION DATA

Laser Classification	Class 3B
Green Laser Medium	DPSS Nd:YVO4, 532nm
Red Laser Medium	LD GaAlAs 650nm, typical
Beam Diameter	<5mm at aperture
Pulse Data	All pulses < 4Hz (>0.25sec)
Divergence (each beam)	<2 mrad
Divergence (total light)	<160 degrees
Laser Power	Red>100mW, Green>30mW

As measured under IEC measurement conditions for classification.

LASER COMPLIANCE STATEMENT

This laser product complies with EN/IEC 60825-1 Ed 2, 2007-03, and US FDA/CDRH FLPPS via the terms of Laser Notice No. 50 dated June 24, 2007.

GENERAL SAFETY INSTRUCTIONS

Every person involved with installation and maintenance of this device have to:

- Be qualified
- Follow the instructions of this manual

CAUTION! Be careful with your operations. With a high voltage you can suffer a dangerous electric shock when touching the wires!

This device has left out premises in absolutely perfect condition. In order to maintain this condition and to ensure a safe operation, it is necessary for the user to follow the safety instructions and warning notes written in this manual.



Important! The manufacturer will not accept liability for any resulting damages caused by the non-observance of this manual or any unauthorized modification to the device.

- Please consider that damages caused by manual modifications to the device are not subject to warranty.
- Never let the power-cord come into contact with other cables! Handle the power-cord and all connections with the mains with particular caution!
- Make sure that the available voltage is not higher than stated on the rear panel.
- Always plug in the power plug least. Make sure that the power-switch is set to off-position before you connect the device to the mains. The power-plug has to be accessed after installing the device.
- Make sure that the power-cord is never crimped or damaged by sharp edges. Check the device and the power-cord from time to time.
- Always disconnect from the mains, when the device is not in use or before cleaning it. Only handle the power-cord by the plug. Never pull out the plug by tugging the power-cord.
- It is essential to connect the yellow/green conductor to earth.

- The electric connection, repairs and servicing must be carried out by a qualified employee.
- Do not switch the fixture on and off in short intervals as this would reduce the laser diode life.
- For replacement, please use fuses of same type and rating only.
- If the device has been exposed to drastic temperature fluctuation, do not switch it on immediately. The arising condensation water might damage your device. Leave the device switched off until it has reached room temperature.
- Do not shake the device. Avoid brute force when installing or operating the device.
- When choosing the installation-spot, please make sure that the device is not exposed to extreme heat, moisture or dust. There should not be any cables lying around. You endanger your own and the safety of others!
- The minimum distance between the fixture and surrounding walls must be more than 50cm.
- Always fix the fixture with an appropriate safety-rope. Fix the safety-rope at the safety-rope only.
- The ambient temperature must be between 10°C to 40°C.
- Please use the original packaging if the device is to be transported.
- Please consider that unauthorized modifications on the device are forbidden due to safety reasons!

CAUTION! Operate the device only after having familiarized with its functions. Do not permit operation by persons not qualified for operating the device. Most damages are the result of unprofessional operation!

CAUTION! If this device will be operated in any way different to the one described in this manual, the product may suffer damages and the warranty void.

BEFORE OPERATION

Unpacking Instructions

⚠ CAUTION! Immediately upon receiving a fixture, carefully unpack the carton, check the contents to ensure that all parts are present, and have been received in good condition. Notify the shipper immediately and retain packing material for inspection if any parts appear damage from shipping or the package itself shows signs of mishandling. Save the package and all packing materials. In the event that a fixture must be returned to the factory, it is important that the fixture be returned in the original factory box and packing.

What is included

The carton or flight case contain following items:

NAME	QTY
Laser Light	1 PCS
KEYS (for key switch)	2 PCS
Interlock Connector	1 PCS
Mains Cable	1 PCS
USER MANUAL	1 PCS

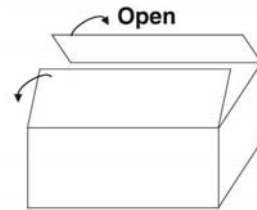

Power Supply

To determine the power requirements for a particular fixture, see the label affixed to the back plate of the fixture or refer to the fixture's specifications chart. A fixture's listed current rating is its average current draw under normal conditions. All fixtures must be powered directly off a switched circuit and cannot be run off a rheostat (variable resistor) or dimmer circuit, even if the rheostat or dimmer channel is used solely for a 0% to 100% switch. Before applying power to a fixture, check that the source voltage matches the fixture's requirement.

The unit is supplied with a power plug appropriate to its voltage and destination. Should any other connections be required they must be carried out with the following configuration.

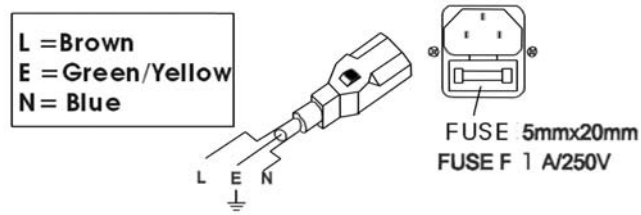

Cable(EU)	Cable(US)	Pin	International
Brown	Black	Live	L
Light blue	White	Neutral	N
Yellow/Green	Green	Earth	

DMX-512 connection between fixtures

The fixture is equipped with 3-pin XLR sockets for DMX input and output. The sockets are wired in parallel. Only use a shielded twisted-pair cable designed for 3-pin XLR-plugs and connectors in order to connect the controller with the fixture or one fixture with another.

Occupation of the XLR-connection

DMX - output
XLR mounting-sockets (rear view):



- 1 - Shield
- 2 - Signal (-)
- 3 - Signal (+)

DMX-input
XLR mounting-plugs (rear view):

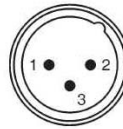

Caution:

At the laser fixture, the DMX-cable has to be terminated with a terminator. Solder a 120 Ohm resistor between Signal (-) and Signal (+) into a 3-pin XLR-plug and plug it in the DMX-output of the last fixture.

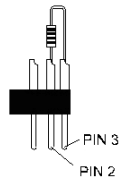

Building a serial DMX-chain

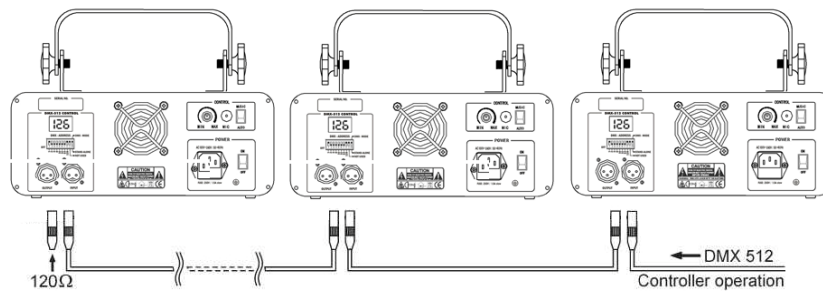

- If you are using the standard DMX-controllers, you can connect the DMX-output of the controller directly with the DMX-input of the first fixture in the DMX-chain. If you wish to connect DMX-controllers with other XLR-outputs, you need to use adapter cables.
- Connect the DMX-output of the first fixture in the DMX-chain with the DMX-input of the next fixture. Always connect output with the input of the next fixture until all fixtures are connected.
- If you use a controller with 5 pins DMX connector, you need to use a 5 to 3 pins adapter.
- At last fixture, the DMX cable has to be terminated with a terminator. Solder a 120 Ohm 1/4W resistor between pin 2(DMX-) and pin 3(DMX+) into a 3 pins XLR-plug and plug it in the DMX-output of the last fixture.
- Connect the fixture together in a daisy chain by XLR plug cable from the output of the fixture to the input of the next fixture. The cable cannot be branched or split to a Y cable. DMX 512 is a very high speed signal. Inadequate or damaged cables, soldered joints or corroded connectors can easily distort the signal and shut down the system.
- The DMX output and input connectors are pass-through to maintain the DMX circuit, when power is disconnected to the unit.
- Each fixture needs to have a DMX address to receive the data from the controller. The DMX address number which could be read from rear panel of each fixture is between 000~511.
- The end of the DMX 512 chain should be terminated to reduce signal errors.

Proper Laser Set Up & Usage

This fixture has been designed to be hung. It is recommended for safety purposes, your lighting effect are properly mounted using a suitable hanging clamp and safety cable. Items appropriate for safe and effective mounting are easily sourced from your lighting vendor.

International laser safety regulations require that lasers must be operated in the fashion illustrated below, with a minimum of 3 meters (9.8 ft) of vertical separation between the floor and the lowest laser light vertically. Additionally, 2.5 meters of horizontal separation is required between laser light and audience or other public spaces.

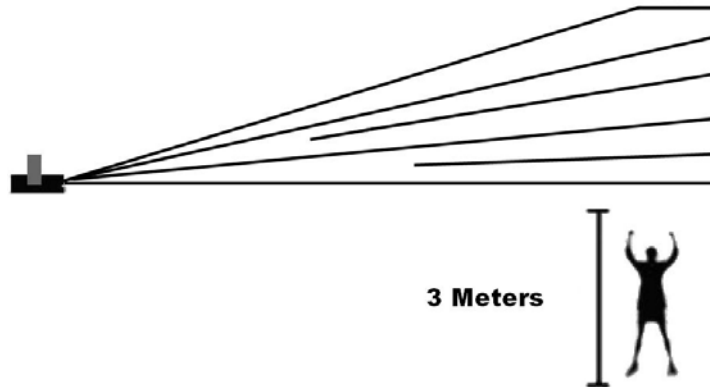

CAUTION: Use of controls, adjustments, or performance of procedures other than what is specified herein may result in hazardous radiation exposure

Rigging the Fixture

CAUTION: Please consider the respective national norms during the installation! The installation must only be carried out by an authorized employee or dealers!

- The installation of the fixture has to be built and constructed in a way that it can hold 10 times the weight for 1 hour without any harming deformation.
- The installation must always be secured with a secondary safety attachment, e.g. an appropriate catch net. This secondary safety attachment must be constructed in a way that no part of the installation can fall down if the main attachment fails.
- Make sure the area below the installation place is free from unwanted persons during rigging, de-rigging and servicing.
- The operator has to make sure that safety-relating and machine-technical installations are approved by an expert before taking into operation for the first time and after changes before taking into operation another time.
- The operator has to make sure that safety-relating and machine-technical installations are approved by a skilled person once a year.
- The fixture should be installed in the position where persons cannot reach and where persons may walk by or be seated.

CAUTION: When installing the device, make sure there is no highly inflammable material (decoration articles, etc.) in between a distance of min 0.5 meter.

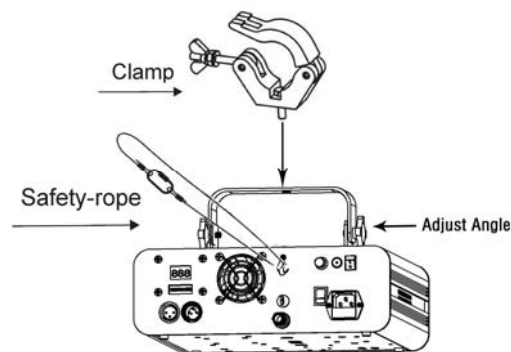

PRODUCT OVERVIEW

- This device has left out premises in absolutely perfect condition. In order to maintain this condition and to ensure a safe operation, it is necessary for the user to follow the safety instructions and warning notes written in this manual.
- The manufacturer will not accept liability for any resulting damages caused by the non-observance of this manual or any unauthorized modification to the device.

Front Panel

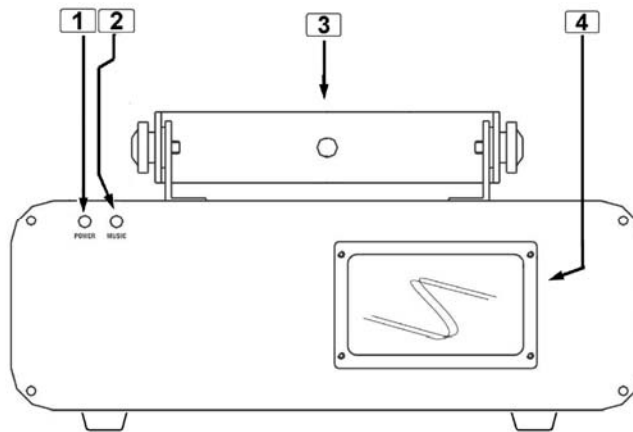

NO.	NAME	DESCRIPTION
1	Power LED	Indicates the fixture is switched on
2	Music LED	Synchronize to detected music signal
3	Bracket	To fasten the fixture with mounting hook
4	Laser Aperture	The laser effect output aperture. NEVER LOOK INSIDE THE FIXTURE THROUGH THIS APERTURE WHILE FIXTURE IS OPERATING.

Rear Panel

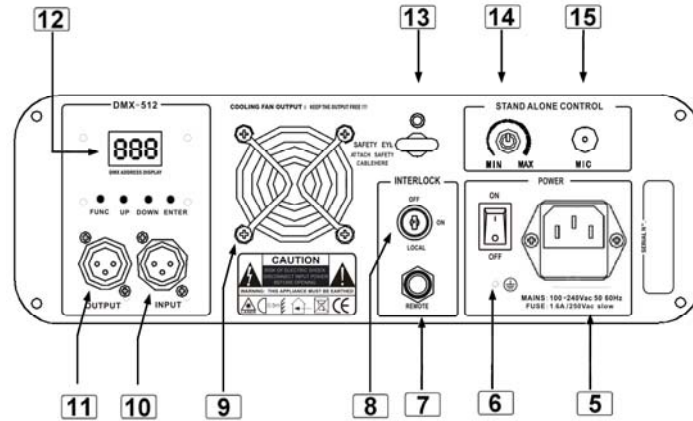

NO.	NAME	DESCRIPTION
5	Power Switch	Switch ON and OFF the fixture
6	Main Power Input	With IEC socket and integrated fuse holder.
7	Interlock	Used to connect the optional emergency stopper. When you push this switch the laser effect will be blank-out immediately.
8	Key Switch	To turn the laser effect (laser diode) ON/OFF. Be sure that only authorized operator hold the key
9	Cooling Fan	Used to cool the components inside the enclosure. Never cover this fan outlet!
10	DMX Input	3 pins male XLR connector
11	DMX Output	3 pins female XLR connector
12	Control panel	To control the fixture with digital LED display, check more information on CONTROL & FUNCTION
13	Safety Eye	Used to attach a safety cable when the fixture is rigged. Check more details in RIGGING
14	Mic Sensitivity Knob	Turn the knob (potentiometer) until the laser works in sync with the music.
15	Microphone	To detect the music/sound signal



IMPORTANT

For your own safety and full laser safety regulation, we do strongly recommend you to take this optional switch!



CONTROL & FUNCTION

- Regular breaks during operation are essential to maximize the life of this device as it is not designed for continual use.
- Do not switch the unit on and off in short time intervals
- Always unplug the unit when it is not used for a longer time. Or before replacing the bulb or start servicing.
- In the event of serious operation problems, stop using the fixture and contact your dealer immediately.

ATTENTION: Laser will be output from laser aperture in 5 seconds after the unit is powered on.

Operating Mode

When laser is powered on, LED monitor on rear panel shows the current operating standalone mode or DMX address of DMX mode. With help of LED control panel, it is very easy to set and change the operating mode of laser. After every resetting and saved, the new mode information will be shown on LED monitor at next power on.



Mode/Function Option, to choose the operating mode of laser.



Confirmation, to confirm all setting or change of LED control panel.



UP/DOWN, to change operating mode, parameter or DMX address.



Operation

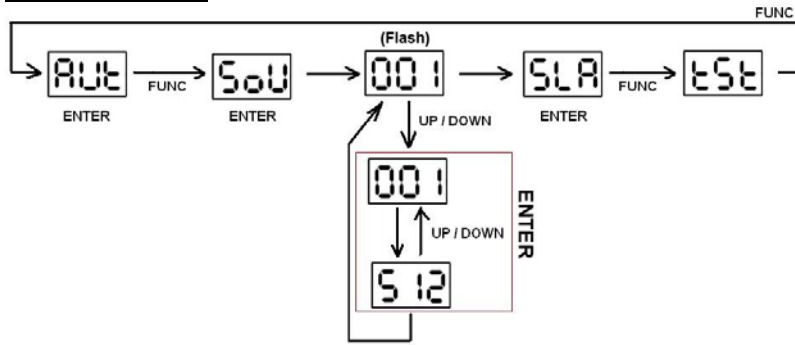

AUTO SHOW Stand Alone Mode

- Press FUNC to enter MODE OPTION.
- Till to LED panel shows AUt.
- Press ENTER to confirm the setting.

The laser is working in standalone mode – AUTO SHOW. Each time when you turn on your laser, you will have this confirmed laser show.

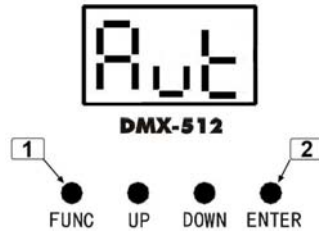

SOUND AVTIVATED SHOW (MUSIC SHOW) Stand Alone Mode

- Press FUNC to enter MODE OPTION.
- Till to LED panel shows SoU.
- Press ENTER to confirm the setting.

The laser is working in standalone mode – SOUND ACTIVATED SHOW. Each time when you turn on your laser, you will have this confirmed laser show.

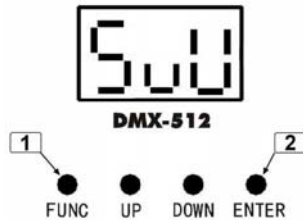

DMX MODE

- Press FUNC to enter MODE OPTION
- Till to LED panel shows 001.
- Press ENTER to confirm the setting.

The laser is working in “DMX MODE”. With help of UP/DOWN button, it could be easily change the DMX address of the laser.

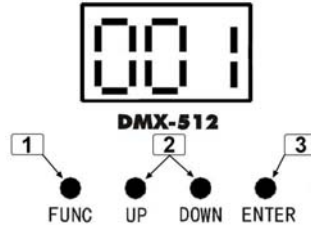

MASTER/SLAVE MODE

- Press FUNC to enter MODE OPTION
- Till to LED panel shows SLA
- Press ENTER to confirm the setting.

The laser is working in “SLAVE MODE”. Connect MASTER laser and SLAVE lasers with DMX cable, the SLAVE lasers do what exactly MASTER laser does. Check “5.2 DMX connection” to have more details about laser connection.

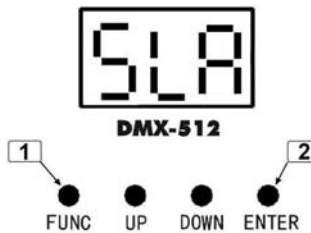







TESTING MODE

- Press FUNC to enter MODE OPTION
- Till to LED panel shows tSt
- Press ENTER to confirm the setting.











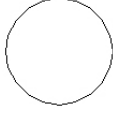







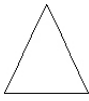

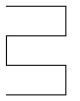



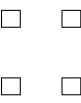
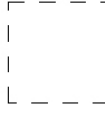

The laser is working in “TESTING MODE”. In this mode a fixed testing pattern is done which people could see how the laser projector working. PS: This mode is for service only.

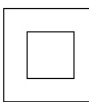

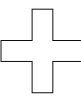

DMX PROTOCOL

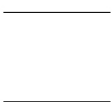
CHANNEL	VALUE	FUNCTION	
CH 1 MODE	000-063	Laser Block Out	⓪
	064-127	AUTO SHOW	
	128-191	SOUND ACTIVATED SHOW (MUSIC)	
	192-255	DMX MODE (Other channels activated)	
CH 2	000-255	32 Patterns as shown in PATTERN LIST	
CH 3 ZOOMING	0-127	100%-5% Size	
	128-169	Zooming In	
	170-209	Zooming Out	
	210-255	Zooming In & Out	
CH 4 Y AXIS ROLLING	000-127	0 -359 degree fixed Y axis rolled	
	128-191	Clockwise rolling	
	192-255	Anticlockwise rolling	
CH 5 X AXIS ROLLING	000-127	0 -359 degree fixed X axis rolled	
	128-191	Clockwise rolling	
	192-255	Anticlockwise rolling	
CH 6 Z AXIS ROTATING	000-127	0 -359 degree fixed Z axis rotate	
	128-191	Clockwise rotating	
	128-255	Anticlockwise rotating	
CH 7 X AXIS MOVING	000-127	128 different fixed position on X	
	128-191	Clockwise moving	
	128-255	Anticlockwise moving	
CH 8 Y AXIS MOVING	000-127	128 different fixed position on Y	
	128-191	Clockwise moving	
	128-255	Anticlockwise moving	

CH 9 COLOR	000-031	Original Color	
	032-063	Red	
	064-095	Green	
	096-127	Yellow	
	128-255	Color Rolling	

PATTERN LIST IN CHANNEL 2

DMX	PATTERNS	DMX	PATTERNS	DMX	PATTERNS	DMX	PATTERNS
000-007		064-071		128-135		190-197	
008-015		072-079		136-143		198-205	
016-023		080-087		144-151		206-213	
024-031		088-095		152-159		214-221	
032-039		096-103		160-167		222-229	
040-047		104-111		168-175		230-237	
048-055		112-119		176-181		238-245	

056-063		120-127		182-189		246-255	
---------	---	---------	---	---------	--	---------	---

MAINTENANCE

- Make sure the area below the installation place is free from unwanted persons during servicing
- Switch off the fixture, unplug the mains cable and wait until the unit has been cooled down.
- Housings, fixations and installations spots(ceiling, truss, suspensions) should be totally free from any deformation
- The mains cables must be in impeccable condition and should be replaced immediately when even a small problem is detected
- In order to protect the fixture from overheat the cooling fans (if any) and ventilation openings should be cleaned monthly.
- The cleaning of aperture glass and scanner mirrors must be carried out periodically to optimize light output. Cleaning frequency depends on the environment in which the fixture operates: damp, smoky or particularly dirty surroundings can cause greater accumulation of dirt on the unit's optics
 - 1) Clean with a soft cloth using normal glass cleaning products.
 - 2) Always dry the parts carefully.
 - 3) Clean the Aperture glass at least once every 30 days
- The interior of the fixture should be cleaned annually using a vacuum cleaner or air-jet.

ATTENTION: We strongly recommend internal cleaning to be carried out by qualified worker!

TROUBLE SHOOTING

Following are a few common problems that may occur during operation. Here are some suggestions for easy troubleshooting:

- The fixture does not work, no laser and the fan does not work.

- 1) Check the connect power and main fuse.
 - 2) Measure the mains voltage on the main connector.
 - 3) Check the power on indicated LED.
-
- The fixture is power on, but no laser coming out from aperture.
 - 1) Check the laser aperture cover.
 - 2) Check the key switch.
 - 3) Check the remote interlock or interlock connector.
 - 4) Wait for at least 30 minutes to warm up in low temperature.
 - 5) Check whether it is in music mode without sound signal.
 - 6) Check whether it is in Slave mode.
 - 7) Check whether it is in DMX without DMX signal.

 - The laser effect power is very weak.
 - 1) Wait for at least 30 minutes to warm up in low temperature.
 - 2) Clean the scanner mirror with alcohol.
 - 3) Clean the aperture glass with alcohol.
 - 4) Check whether it is in DMX with high strobe frequency.

 - The laser is on, but the pattern is not moving.
 - 1) Check to see whether it is in Music/Sound mode without detecting sound signal.
 - 2) Check to see whether it is in DMX mode with further DMX control.
 - 3) Try to change the fixture to another stand alone mode.
 - 4) Try to control the fixture with DMX to see the laser effect system.

 - Not responding to DMX controller
 - 1) Check the DMX address settings and DMX polarity
 - 2) If you have intermittent DMX signal problems, check the pins on connectors of the fixture or the previous one.
 - 3) Try to use another DMX controller.
 - 4) Check to see if the DMX cables run near or run alongside to high voltage cables that may cause damage or interference to DMX interface circuit.

SPECIFICATIONS

Mains Input:	AC100-240V, 50/60Hz
Fuse:	250V 1.6A Slow Blow (20mm Glass)
Total Power:	20W
Music Control:	Internal microphone
Laser Power:	100-R + 130mW-Y + 30mW-G CW
Laser Classification:	Class 3B
Laser Safety Standard:	EN60825-1 2007
Condition Temperature:	10~40°C
DMX Connections:	3 pins XLR Male/Female
DMX Channels	9 channels
Measurement:	See diagram below
N Weight:	3.6 Kg

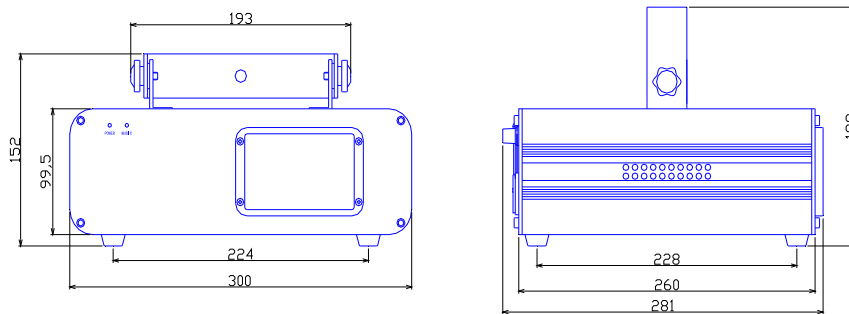

Specifications subject to change without prior notice.

The availability of particular products may vary by region. Please check with the dealer.