



## DIGITAL MIXING CONSOLE

---

# QL5 QL1

# Reference Manual

### How to Use This Reference Manual

The QL5/QL1 Reference Manual (this document) allows you to search for terms and take advantage of links in the text.

#### Searching for terms

To search for a term, use the search function of the software you're using to view this document.

If you're using Adobe Reader, enter the term in the search box and press the <Enter> key of your computer keyboard to search for occurrences of that term.

#### Displaying the next/previous view

If you're using Adobe Reader, you can jump to the previous/next view in your viewing history. This is a convenient way to jump back to the previous page after you've used a link to jump to a different page.

#### Using the Function Tree

A function tree for the QL series is provided on [page 4](#) and following. You can use this function tree to find the page that explains an on-screen display or function.

# Contents

- How to Use This Reference Manual ..... 1
- Function Tree ..... 4**
- SELECTED CHANNEL section ..... 6**
  - Operations in the SELECTED CHANNEL section ..... 6
- Channel Strip section..... 11**
  - Operations in the Channel Strip section..... 11
- Input and output patching..... 14**
  - Changing the input patch settings..... 15
  - Changing the output patch settings ..... 16
  - Inserting an external device into a channel ..... 18
  - Directly outputting an INPUT channel ..... 21
- Input channels ..... 23**
  - Signal flow for input channels..... 23
  - Specifying the channel name, icon, and channel color..... 24
  - Making HA (Head Amp) settings..... 26
  - Sending the signal from an input channel to the STEREO/MONO bus ..... 30
  - Sending a signal from an input channel to a MIX/MATRIX bus ..... 34
  - Correcting delay between channels (Input Delay)..... 37
  - Channel library operations..... 39
- OUTPUT channels ..... 40**
  - Signal flow for output channels ..... 40
  - Specifying the channel name, icon, and channel color..... 41
  - Sending signals from MIX channels to the STEREO/MONO bus ..... 42
  - Sending signals from MIX channels and STEREO/MONO channels to  
MATRIX buses..... 44
  - Correcting delay between channels (Output Delay) ..... 46
  - Using the PORT TO PORT function ..... 47
  - Channel library operations..... 48
- EQ and Dynamics ..... 49**
  - Using EQ ..... 49
  - Using dynamics ..... 52
  - Using the EQ or Dynamics libraries ..... 55

- Channel Job ..... 56**
  - DCA group ..... 56
  - Mute group..... 58
  - Using the Recall Safe function..... 61
  - Channel Link function ..... 64
  - Copying, moving, or initializing a channel..... 67
- Scene memory ..... 71**
  - Storing and recalling scenes ..... 72
  - Editing scene memories..... 75
  - Using the Global Paste function..... 78
  - Using the Focus Recall function ..... 80
  - Using the Fade function..... 82
  - Outputting a control signal to an external device in tandem with scene recall  
(GPI OUT) ..... 83
  - Playing back an audio file that links to a scene recall..... 84
  - Using Preview mode..... 86
- Monitor and Cue functions ..... 87**
  - Using the Monitor function ..... 88
  - Using the Cue function..... 91
- Talkback and Oscillator..... 96**
  - Using Talkback ..... 96
  - Using the Oscillator function ..... 98
- Meters..... 101**
  - Operations in the METER screen ..... 101
- Graphic EQ, effects, and Premium Rack..... 103**
  - About the virtual rack ..... 103
  - Virtual rack operations ..... 103
  - Graphic EQ operations ..... 106
  - About AUTOMIXER..... 109
  - Editing the internal effects ..... 112
  - Effects and tempo synchronization ..... 117
  - Using the Premium Rack..... 119
  - Using the graphic EQ, effect, and Premium Rack libraries ..... 126

**I/O devices and external head amps ..... 127**

- Using an I/O device ..... 127
- Remotely controlling an Rio unit ..... 129
- Remotely controlling an amp ..... 131
- Remotely controlling WIRELESS unit ..... 132
- Using an external head amp ..... 133
- Remotely controlling an external head amp ..... 135
- Controlling an internal head amp ..... 137

**MIDI ..... 138**

- MIDI functionality on the QL series console ..... 138
- Basic MIDI settings ..... 138
- Using program changes to recall scenes and library items ..... 141
- Using control changes to control parameters ..... 143
- Using Parameter Changes to control parameters ..... 145

**Recorder ..... 146**

- About the USB memory recorder ..... 146
- Assigning channels to the input/output of the recorder ..... 146
- Recording audio to a USB flash drive ..... 148
- Playing back audio files from a USB flash drive ..... 150
- Editing the title list ..... 151
- Recording or playing back using a computer DAW ..... 152
- Using the QL console with Nuendo Live ..... 155

**Setup ..... 159**

- About the SETUP screen ..... 159
- User settings ..... 160
- Preferences ..... 167
- USER DEFINED keys ..... 169
- Functions that can be assigned to USER DEFINED keys ..... 170
- USER DEFINED knobs ..... 173
- Functions that can be assigned to USER DEFINED knobs ..... 174
- Custom fader bank ..... 175
- Console Lock ..... 176
- Saving and loading setup data to and from a USB flash drive ..... 177
- Word clock and slot settings ..... 184
- Using cascade connections ..... 186
- Basic settings for MIX buses and MATRIX buses ..... 189
- Switching the entire phantom power supply on/off ..... 190
- Specifying the brightness of the touch screen, LEDs, channel name displays,  
and lamps ..... 190
- Setting the date and time of the internal clock ..... 191
- Setting the network address ..... 191

- Setting up the Dante audio network ..... 192
- Using GPI (General Purpose Interface) ..... 203

**Help function ..... 208**

- Loading a Help/text file from a USB flash drive ..... 208
- Viewing Help ..... 208
- Using USER DEFINED keys to recall Help directly ..... 209

**Other functions ..... 210**

- Initializing the unit to factory default settings ..... 210
- Adjusting the detection point of the touch screen (Calibration function) ..... 210
- Adjusting the faders (Calibration function) ..... 211
- Fine-tuning the input and output gain (Calibration function) ..... 211
- Adjusting the LED color (Calibration function) ..... 213
- Adjusting the brightness of the channel name display ..... 213
- Adjusting the contrast of the channel name display ..... 214
- Initializing the Dante audio network settings ..... 214

**Warning/Error Messages ..... 215**

**Index ..... 218**

# Function Tree

Page numbers in parentheses ( ) are the page numbers of the Owner's Manual (booklet).

<b>Main</b>	
SELECTED CHANNEL	6
OVERVIEW	11
FUNCTION ACCESS AREA	(17)

<b>CHANNEL PARAMETER</b>	
PATCH/NAME	15, 24, 41
GAIN/PATCH	26
1ch	26
8ch	27
CH1-32	29
CH33-64/ST IN	29
OUTPUT	Indication only
INPUT DELAY	37
8ch	38
CH1-32	38
CH33-64/ST IN	38
DELAY SCALE	38
INSERT/DIRECT OUT	19
1ch	19, 21
8ch	19, 22
HPF/EQ	49
1ch	49
8ch	51
CH1-32	51
CH33-64/ST IN	51
OUTPUT	51
DYNAMICS	52
1ch	52
KEY IN SOURCE SELECT	53
8ch	54
CH1-32	54
CH33-64/ST IN	54
OUTPUT	54

TO STEREO/MONO	42
8ch	42
CH1-32	43
CH33-64/ST IN	43
OUTPUT	43

<b>LIBRARY</b>	
CHANNEL LIBRARY	39
EQ LIBRARY	55
DYNAMICS LIBRARY	55
GEQ LIBRARY	126
EFFECT LIBRARY	126
Portico5033/Portico5043/U76/Opt-2A/ EQ-1A/DynamicEQ LIBRARY	126
DANTE INPUT PATCH LIBRARY	128

<b>RACK</b>	
VIRTUAL RACK	103
RACK MOUNTER	106
GEQ EDIT	107
GEQ LINK	107
EFFECT RACK	114
EFFECT EDIT	114
EFFECT TYPE	114
PREMIUM RACK	119
PREMIUM RACK MOUNTER	119
PREMIUM RACK EDIT	120

<b>I/O DEVICE</b>	
DANTE PATCH	127
DANTE SETUP	127
DANTE INPUT PATCH	128
DANTE OUTPUT PATCH	129
Rio	130
REMOTE HA EDIT	131
DANTE OUTPUT PATCH	129

AMP	132
DANTE OUTPUT PATCH	129
WIRELESS	132
EXTERNAL HA	135
EXTERNAL HA PORT SELECT	136
EXTERNAL HA EDIT	136
INTERNAL HA	137

<b>MONITOR</b>	
MONITOR	88
CUE	94
MONITOR	89
OSCILLATOR	99
TALKBACK	97

<b>METER</b>	
INPUT METER	101
OUTPUT METER	101

<b>SETUP</b>	
USER SETUP	159
PREFERENCE	167
USER DEFINED KEYS SETUP	169
USER DEFINED KEY SETUP (List)	169
USER DEFINED KNOBS SETUP	173
USER DEFINED KNOB SETUP (List)	173
CUSTOM FADER BANK/MASTER FADER	175
FADER ASSIGN SELECT	175
USER LEVEL/CREATE USER KEY	160
CREATE KEY	162
SAVE KEY	165
LOGIN	163
SAVE/LOAD	177
WORD CLOCK/SLOT	184
CASCADE IN/OUT PATCH	187, 188
OUTPUT PORT	46

<b>SETUP</b>	
MIDI/GPI	138, 203
MIDI SETUP	139
PROGRAM CHANGE	141
CONTROL CHANGE	144
GPI	204
FADER START	206
BUS SETUP	189
CONSOLE LOCK	176
DATE/TIME	191
NETWORK	192
DANTE SETUP	192

<b>SCENE</b>	
SCENE LIST	73
GLOBAL PASTE	78
FADE TIME	82
SONG SELECT	85
FOCUS RECALL	81
PREVIEW	86

<b>RECORDER</b>	
USB	146
NUENDO LIVE	155

<b>CH JOB</b>	
CH LINK MODE	65
DCA GROUP ASSIGN	57
MUTE GROUP ASSIGN	59
RECALL SAFE MODE	61
CH COPY MODE	68
CH MOVE MODE	69
CH DEFAULT MODE	70

<b>PATCH</b>	
PORT SELECT	20, 22, 28, 91, 95, 128, 136, 188
CH SELECT	17, 104, 147, 175

<b>Others</b>	
CONFIRMATION	167
SOFT KEYBOARD	(23)
LOGIN	163

<b>Startup Menu</b>	
MODE SELECT	210
INITIALIZE ALL MEMORIES	210
INITIALIZE CURRENT MEMORIES	210
TOUCH SCREEN CALIBRATION	210
INPUT PORT TRIM	212
OUTPUT PORT TRIM	212
SLOT OUTPUT TRIM	212
FADER CALIBRATION	211
CHANNEL COLOR CALIBRATION	213

**NOTE**

- The explanations in this reference manual will use the QL5.
- In the case of the QL1, some screens will not show channels and faders that do not exist on those models.

# SELECTED CHANNEL section

The SELECTED CHANNEL section located at the right of the display corresponds to a channel module of a conventional analog mixer, and allows you to use the knobs on the panel to set all the major parameters of the currently-selected channel.

Operations in this section will affect the channel that was most recently selected by its [SEL] key. If you have assigned an ST IN channel or STEREO channel to a single channel strip, either the L or the R channel will be selected, and the major parameters for L and R channels will be linked.

## Operations in the SELECTED CHANNEL section

Follow the steps below to perform operations in the SELECTED CHANNEL section.

### STEP

1. Press the Bank Select keys in the Fader Bank section to select the bank that includes the channel you want to operate.
2. Use a [SEL] key in the top panel channel strip section or the master section, to select the channel to control.
3. If the SELECTED CHANNEL VIEW screen is not displayed, press one of the knobs in the SELECTED CHANNEL section.
4. Use the knobs and the buttons in the screen to edit the parameters of the selected channel.

### NOTE

- The number and name of the currently-selected channel is shown in the channel select field located in the Function Access Area of the touch screen.
- If an ST IN channel or STEREO channel has been assigned to a single channel strip, you can switch between L and R by repeatedly pressing the same [SEL] key.
- You can also switch channels by pressing the channel select field located in the Function Access Area. Press the left side of the field to select the preceding channel. Press the right side of the field to select the next channel.
- If you have turned on the option "POPUAPPEARS WHEN KNOB(S) PRESSED" on the PREFERENCE tab (accessed by pressing the SETUP button, then the USER SETUP button), pressing a knob repeatedly will open or close the screen (1ch).
- Even if a different screen is selected, the channel selected with the [SEL] key can be set using the knobs of the SELECTED CHANNEL section. In this case, a window indicating the value of that parameter will appear on screen when you operate a knob.

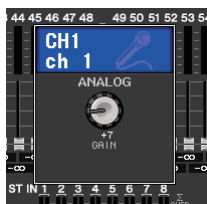
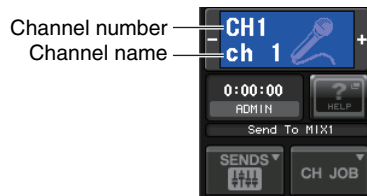

# SELECTED CHANNEL VIEW screen



## SEND field

In this field, you can view the send level and pre/post from the channel to each MIX/MATRIX bus. You can also switch the on/off status of the send signals. The view and the function of the knobs and buttons in the SEND field vary depending on whether a pair of bus channels (odd-numbered and even-numbered) are comprised of two mono channels or a stereo channel.

### 1 Tabs

- Enable you to select a group of 16 output bus channels to be displayed in the SEND field.
- **MIX tab** ..... displays MIX buses 1–16.
  - **MATRIX tab** ..... displays MATRIX buses 1–8.



If the destination bus channels are two mono channels:

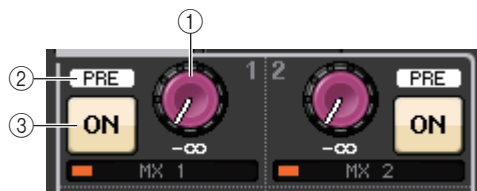

- ① **SEND knob**  
Adjusts the send level to the corresponding bus.
- ② **PRE indicator**  
Indicates the send point of the corresponding bus. If the PRE button on the MIX SEND 8ch screen is turned ON, this PRE indicator will be turned on.
- ③ **ON button**  
Switches the send signal to the corresponding bus on or off.

If the destination bus is a stereo channel:

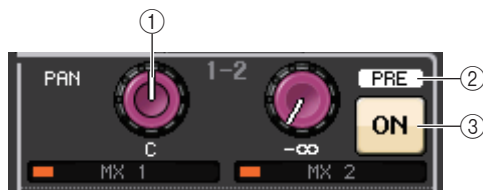

- ① **SEND/PAN knob**  
The right-hand knob adjusts the level of the signal sent to a pair of bus channels (even-numbered and odd-numbered). The left-hand knob adjusts the pan and balance of the same signal.
- ② **PRE indicator**  
Indicates the send point of the corresponding bus. If the PRE button on the MIX SEND 8ch screen is turned ON, this PRE indicator will be turned on.
- ③ **ON button**  
Switches the send signal to the two buses on or off.

#### NOTE

- If the indices of a SEND/PAN knob are white, the send point is assigned as PRE; if the indices are black, it is assigned as POST.
- If the send point is PRE, you can specify the PRE point as either VARI [PRE EQ] or VARI [PRE FADER] in the BUS SETUP popup that appears when you press the SETUP button → BUS SETUP button.
- If the type of the destination bus is set to FIXED, controllers ①–② mentioned above will not be displayed. The send level will be fixed at nominal level, and the send point will be fixed at POST FADER. For details, see “Basic settings for MIX buses and MATRIX buses” on page 189.
- Press the SEND knob or PAN knob on screen to open the SEND 8ch window.

## ■ GAIN/PATCH field

This field enables you to make HA (head amp) analog or digital gain settings. You can also view the operational status of the head amp.

- ① **GAIN knob**  
Sets the analog gain/digital gain of the head amp.  
Press the knob to open the GAIN/PATCH 1ch window.
- ② **GC indicator**  
Indicates the level of the signal output to the audio network if the Gain Compensation function is turned on.
- ③ **OVER indicator**  
Warns you when the signal is clipping.
- ④ **∅ (Phase) indicator**  
Indicates the status of the phase setting.
- ⑤ **+48V indicator**  
Indicates the phantom power (+48V) on or off status for the head amp.
- ⑥ **HPF ON indicator**  
Indicates the HPF on/off status of the external head amp.
- ⑦ **AG-DG LINK indicator**  
Indicates a link between the analog gain and digital gain of the head amp.
- ⑧ **Digital/Analog gain value**  
If analog gain is assigned to the GAIN knob, the digital gain value is shown here. If digital gain is assigned to the GAIN knob, the analog gain value is shown here.



#### NOTE

- For an input channel that is patched to an input that has no head amp, ①, ②, ⑤, ⑥, and ⑦ will not be shown. For an output channel, ①–⑦ will not be shown.
- If GAIN KNOB FUNCTION is set to DIGITAL GAIN in the USER SETUP → PREFERENCE screen, the digital gain knob will appear for ①, and ②, ⑤, ⑥, and ⑦ will not be shown. For details, refer to “Making HA (Head Amp) settings” on page 26.



### ■ PAN/BALANCE field

This field enables you to switch the on/off status of the signal sent from the selected channel to the STEREO/MONO bus, and adjust the pan and balance.

The view and the function of the controllers in this field vary depending on the type of the selected channel.

**When an input channel or MIX channel is selected:**

① **TO STEREO PAN knob**

Sets the pan position of a signal routed to the STEREO bus.

Press the knob to open the STEREO/MONO 8ch window. If the ST IN channel is selected, you can specify whether to view the PAN knob or the BALANCE knob in this window. For a MIX channel, the PAN knob will appear if the signal is mono, and the BALANCE knob will appear if the signal is stereo.



② **ST/MONO button**

Switches the on/off status of a signal sent from the channel to the STEREO/MONO bus.

If an INPUT/MIX channel is set to LCR mode, the LCR button appears in location ②. The LCR button is an overall on/off switch for the signals sent from the channel to the STEREO/MONO bus.



**When a MATRIX, STEREO, or MONO channel is selected:**

① **BALANCE knob**

If the signal on the selected channel is stereo, the BALANCE knob will appear, enabling you to adjust the volume balance for the left and right channels. If the channel signal is monaural, this knob cannot be used.

Press the knob to open the TO STEREO 8ch window.



### ■ INPUT DELAY field

This field enables you to view the delay settings.

① **ON indicator**

Indicates the on/off status of the delay.

② **Delay time**

The delay value is displayed by milliseconds (ms) and also by currently-selected scale. If the scale uses units of ms, the value in the bottom row will not be displayed. Only the ms value appears in the middle row.

Press this field to open the INPUT DELAY 8ch window.

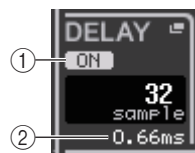

### ■ HPF field (input channels only)

This field enables you to set the HPF. If an output channel is selected, a gray circle will appear in location ①, and ② will not be displayed.

① **HPF knob**

Sets the HPF cutoff frequency.

② **ON button**

Switches the HPF on or off.



### ■ EQ parameter field

This field displays the 4-band EQ parameter settings. Press each knob to open the HPF/EQ 1ch window.

① **Q knob**

Specifies the Q for each band.

If the HIGH band filter type is set to LPF or H. SHELF (high-shelving), or the LOW band filter type is set to L. SHELF (low-shelving), the Q knob will not be displayed. Only the filter type name will be displayed.

**NOTE**

- Fully rotating the HIGH band Q knob on the panel counter-clockwise while pressing and holding it down will set the filter type to LPF. Fully rotating the Q knob clockwise while pressing and holding it down will set the filter type to high-shelving.
- Fully rotating the LOW band Q knob on the panel clockwise while pressing and holding it down will set the filter type to low-shelving.
- If an output channel has been selected, fully rotating the LOW band Q knob on the panel counter-clockwise while pressing and holding it down will set the filter type to HPF.
- You can also switch the filter type in the HPF/EQ 1ch window.

② **FREQUENCY knob**

Sets the center frequency (or cutoff frequency) for each band.

③ **GAIN knob**

Sets the amount of cut/boost for each band.

**NOTE**

- If the HIGH band filter type is set to LPF, you can switch LPF on or off using the HIGH band GAIN knob on the panel.
- If the LOW band filter type is set to HPF, you can switch HPF on or off using the LOW band GAIN knob on the panel.





## EQ graph field

This field graphically indicates the approximate response of the EQ. Press this field to open the HPF/EQ 1ch window, in which you can set the attenuator, HPF, and EQ.

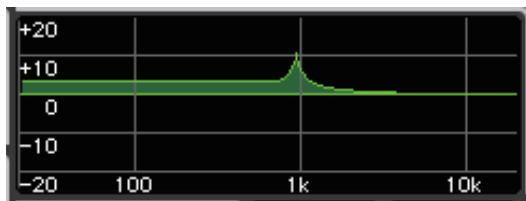

## DYNAMICS 1/DYNAMICS 2 field

This field enables you to set the Dynamics 1/2 parameters.

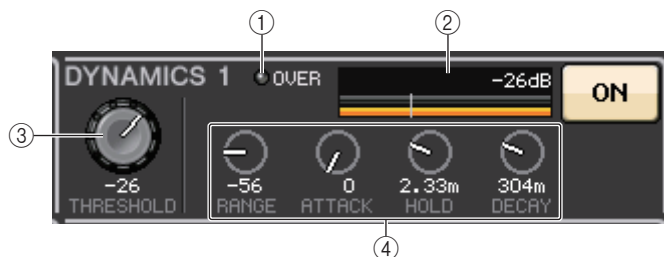

- ① **OVER indicator**  
Warns you when the signal is clipping.
- ② **Level meter**  
Displays the output signal level (green) and the amount of gain reduction (orange) when the Dynamics is on. The current threshold setting is shown as a white vertical line.
- ③ **Threshold**  
Specifies the threshold.
- ④ **Parameters**  
Indicate the values of parameters that vary depending on the currently-selected dynamics type.  
Press this field to open the DYNAMICS 1/DYNAMICS 2 1ch window, in which you can make detailed parameter settings.

## INSERT field

This field enables you to make insert settings.

- ① **Popup button**  
Press this button to open the INSERT/DIRECT OUT 1ch window.
- ② **ON button**  
Switches the insert on or off.
- ③ **RACK EDIT button**  
Appears if an effect or Premium Rack is inserted. Press this button to display the edit screen for the inserted rack.
- ④ **IN indicator**  
Appears if a port has been assigned to the insert-in patch. It lights when the signal is sent to the insert-in.

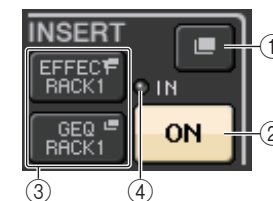

## DIRECT OUT field

This field enables you to make Direct Out settings.

- ① **Popup button**  
Press this button to open the INSERT/DIRECT OUT 1ch window. The Direct Out level value will appear below the button.
- ② **ON button**  
Switches the Direct Out on or off.

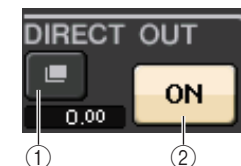

## RECALL SAFE field

This field enables you to make Recall Safe settings.

- ① **Popup button**  
Press this button to open the RECALL SAFE window.
- ② **ON button**  
Switches the Recall Safe status on or off.
- ③ **PARTIAL indicator**  
This will light if recall safe applies only to some of the parameters, not to all channel settings.

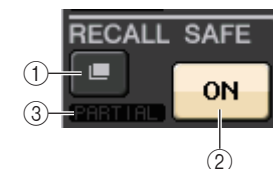

## FADER field

This field enables you to make settings for the channel on/off status and the level.

### ① Fader

Displays the current level.

Use the faders on the top panel to set the levels.

### ② Level indicator

Displays the current level setting by numerical value. If the signal is clipping at any point in the channel, the  $\Sigma$ CLIP indicator will light.

### ③ ON button

Switches the channel on or off. The button is linked with the corresponding [ON] key on the top panel.

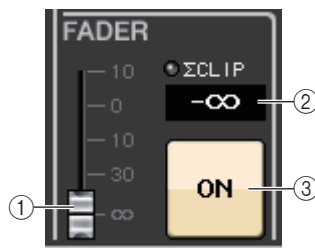

## DCA/MUTE field

This field enables you to select the DCA or mute group to which the channel is assigned.

### ① Tabs

Select a DCA or mute group. Press the selected tab once again to open the DCA/MUTE GROUP ASSIGN MODE window.

#### When the DCA group tab is selected:

### ② DCA group select buttons

Select the DCA group to which the channel is assigned.

### ③ Mute group indicators

Indicate the mute group to which the channel is assigned.

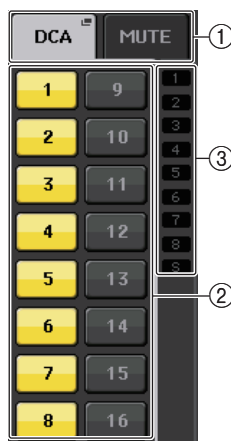

#### When the mute group tab is selected:

### ④ Mute group select buttons

Select the mute group to which the channel is assigned.

### NOTE

If the dimmer level is set to the mute group, this button lights orange.

### ⑤ MUTE SAFE button

Temporarily removes the channel from the mute group.

### ⑥ DCA group indicators

Indicate the DCA group to which the channel is assigned.

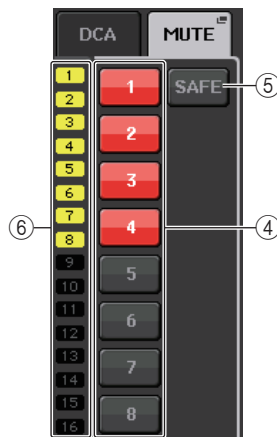

# Channel Strip section

The Channel Strip section located below the touch screen lets you recall and control input channels, output channels, or DCA groups. If you press the Bank Select key in the Fader Bank section, you can control them using the faders, [ON] keys, and [CUE] keys for the channels or DCA groups corresponding to that key.

## Operations in the Channel Strip section

### STEP

1. Use the Bank Select keys to select the channels or DCA groups that you want to control.
2. Use the faders and [ON] keys in the Channel Strip section to adjust the level of the selected channels and switch them on or off.
3. Use the fields on the OVERVIEW screen and the [TOUCH AND TURN] knob to adjust the parameters for the channels.

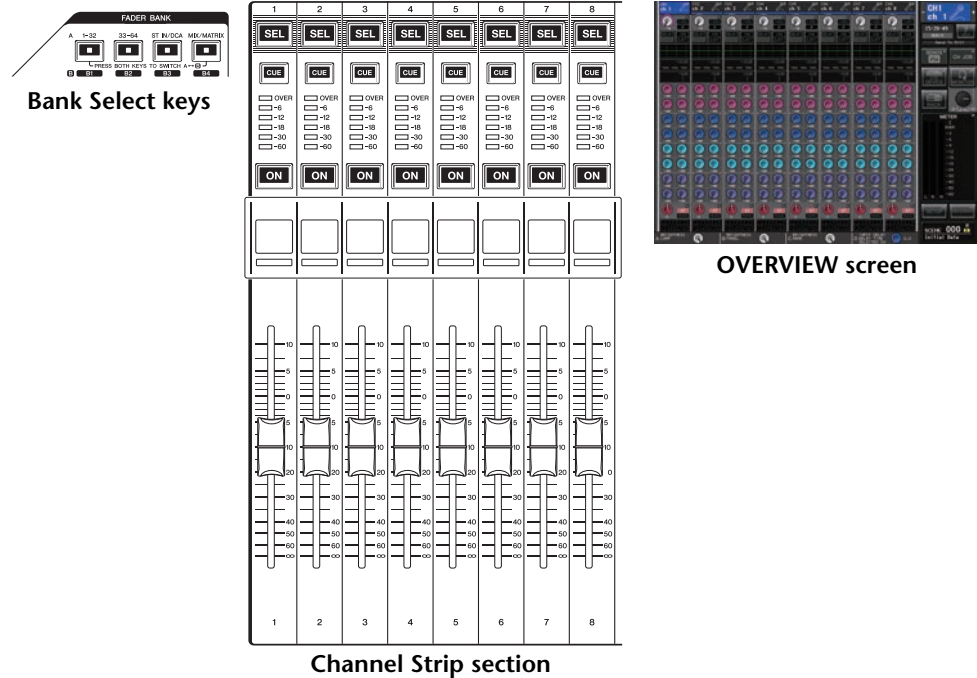

### CHANNEL NAME field

This field appears at the top and bottom of the screen and displays the channel number, name, and icon for the currently-selected eight channels. The name of the currently-selected channel is highlighted.



### GAIN/PATCH field

This field enables you to make HA (head amp) analog or digital gain settings. You can also view the operational status of the head amp.

The view and the function of the controllers in this field vary depending on the type of the selected channel.

#### If the head amp is patched:



- 1 **GAIN knob**  
Sets the analog gain of the head amp.
  - Press this field to assign the GAIN knob to the [TOUCH AND TURN] knob, which enables you to adjust the gain. If the Gain Compensation function is turned on, an indicator appears, showing the level of the signal output to the audio network.
  - If the GAIN knob has been assigned to the [TOUCH AND TURN] knob, press the knob to open the GAIN/PATCH 8ch window.
- 2 **OVER indicator**  
Lights when a signal at the input port or from the rack output exceeds the full scale level. This indicator is available only if an input channel is selected.
- 3 **+48V indicator**  
Indicates the phantom power (+48V) on or off status for the head amp. This indicator is not displayed unless the head amp is patched to the channel.
- 4 **Ø (Phase) indicator (input channels only)**  
Indicates the input phase setting for the head amp.

### NOTE

- If the slot is not connected to the head amp, the patch and the type of the MY card will be displayed.
- Press the SETUP button, then the USER SETUP button, select the PREFERENCE tab, and then set the GAIN KNOB FUNCTION to DIGITAL GAIN. You will be able to adjust the digital gain value by using the [TOUCH AND TURN] knob.

- If GAIN KNOB FUNCTION is set to DIGITAL GAIN, the DIGITAL GAIN knob will appear instead of knob ①, and indicator ③ will not be displayed.
- You can also operate the digital gain by assigning INPUT GAIN → DIGITAL GAIN to a USER DEFINED knob, or by assigning an ALTERNATE function to a USER DEFINED key.



**If the slot is patched:**  
The slot name will appear.



**If the rack is connected:**  
The patch and module name will appear.



**If the output is connected:**  
Only the patch will appear.

### ■ INPUT DELAY field (input channels only)

This field displays the delay status for the input channel. Press this field to open the INPUT DELAY 8ch window.



- ① **DELAY ON/OFF indicator**  
Indicates the on/off status of the delay.

### ■ INSERT/DIRECT OUT field

This field displays the Insert/Direct out status. Press this field to open the INSERT 8ch window.



- ① **INSERT ON/OFF indicator**  
Indicates the insert on/off status.
- ② **DIRECT OUT ON/OFF indicator (input channels only)**  
Indicates the Direct Out on/off status.

### ■ EQ field

This field graphically indicates the approximate response of the EQ. Press this field to open the HPF/EQ 1ch window, in which you can set the HPF and EQ.



#### NOTE

If DCA or monitor has been selected, this field will be blank.

### ■ DYNAMICS 1/2 field

This field displays the threshold value and meter for Dynamics 1/2. Press this field to open the DYNAMICS 1/2 1ch window.



#### NOTE

If DCA or monitor has been selected, this field will be blank.

### ■ SEND field

This field displays the send level, send on/off status, and pre/post settings for 16 buses.

To select the 16 destination buses, use the [MIX/MATRIX] key in the Fader Bank section.

Use the [TOUCH AND TURN] knob to adjust the send level for each bus. Touch the knob of the bus you want to operate; it will be assigned to the [TOUCH AND TURN] knob. If it is assigned to the [TOUCH AND TURN] knob, touching that knob once again will display the SEND 8ch popup screen.

This field varies depending on the type of the destination bus.

#### If the destination bus is VARI (mono):

The knob color and scale color indicate the send on/off and pre/post status. If the send is off, the knob color turns gray. With the post setting, the knob scale color turns gray.



**If the destination bus is VARI (stereo):**

If a pair of buses (odd-numbered and even-numbered) are in stereo, the left-hand knob will function as the PAN knob, and the right-hand knob will function as the SEND knob.

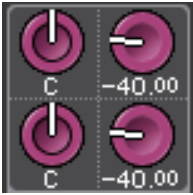

**If the destination bus is set to FIXED:**

The SEND ON/OFF button for each bus is shown instead of the knob.



**TO STEREO/MONO field**

This field displays the on/off status and pan/balance setting of the signal sent to the STEREO/MONO bus.

This field varies depending on the type of the selected channel.

**When an input channel or MIX channel is selected:**



**① TO STEREO PAN knob**

Sets the pan position of a signal routed to the STEREO bus.

Press the knob to open the STEREO/MONO 8ch window. If the ST IN channel is selected, you can specify whether to view the PAN knob or the BALANCE knob in this window. For a MIX channel, the PAN knob will appear if the signal is mono, and the BALANCE knob will appear if the signal is stereo.

**② ST/MONO indicator**

Indicates the status of a signal sent to the STEREO/MONO bus. If an input or MIX channel is set to LCR mode, the LCR indicator will be displayed.



**When a MATRIX channel (monaural) or MONO channel is selected:**

The  $\Sigma$ CLIP indicator will light if the signal is clipping at some point in the channel.



For a stereo MATRIX channel or STEREO channel, the BALANCE knob appears, indicating the balance of the left/right channels.



**DCA group field**

A DCA group (1–16) to which the channel is assigned is displayed on the first or second row in this field.

Press this field to open the DCA/MUTE GROUP ASSIGN MODE window.



**Mute group field**

A mute group (1–8) to which the channel is assigned is displayed on the third row in this field. If the channel has been temporarily removed from the mute group, S (Safe) will appear on the third row. If a dimmer level has been specified for a mute group, the color of the characters will change from red to orange.

Press this field to open the DCA/MUTE GROUP ASSIGN MODE window.



# Input and output patching

This chapter explains how to edit the input patching and output patching, how to connect inserts, and how to use direct outputs.

When the QL series is in the initial state, the following input ports (jacks/ports) are patched to each input channel.

## For QL5

Input channels	Input port (jack/port)
CH1–32	INPUT1–32
CH33–48	DANTE1–16
CH49–64	DANTE17–32
ST IN1–4	FX5L(A)–FX8R(B)

## For QL1

Input channels	Input port (jack/port)
CH1–16	INPUT1–16
CH17–32	DANTE1–16
ST IN1–4	FX5L(A)–FX8R(B)

When the QL is in the initial state, the output ports (jacks/ports) are patched to the following output channels.

Output port (jack/port)	Output channels
OMNI OUT1–14* <sup>1</sup>	MIX1–14* <sup>2</sup>
OMNI OUT15–16* <sup>3</sup>	STEREO L/R
DANTE1–16	MIX1–16
DANTE17–24	MATRIX1–8
DANTE25–26	STEREO L/R
DANTE27	MONO
DANTE28–29	MONITOR L/R
DANTE30	MONITOR C
DANTE31–32	CUE L/R
SLOT1(1)–(16)	MIX1–16
SLOT2(1)–(8)	MATRIX1–8
SLOT2(9)–(10)	STEREO L/R
SLOT2(11)	MONO
SLOT2(12)–(13)	MONITOR L/R
SLOT2(14)	MONITOR C

Output port (jack/port)	Output channels
SLOT2(15)–(16)	CUE L/R
FX5A(L), FX6A(L), FX7A(L), FX8A(L)	MIX13–16
DIGITAL OUT L/R	STEREO L/R
RECORDER IN L/R	STEREO L/R

\*1. QL1: OMNI OUT1–6

\*2. QL1: MIX1–6

\*3. QL1: OMNI OUT7–8

## Input patching

QL series consoles and I/O devices feature two types of patching: Dante audio network patching and QL console internal patching.

For Dante audio network patching, you will use the DANTE INPUT PATCH window. In this window, you can patch the QL console and I/O device inputs. Sixty-four (64) channels for the QL5 and thirty-two (32) channels for the QL1 can be input from a DANTE audio network. Choose channels from Dante audio network signals and select the I/O devices that you want to control from the QL series console.

Then, route the input signals (that were patched in the DANTE INPUT PATCH window) to channels on the QL series console. To do this, choose input ports from DANTE 1–64 (for QL5) or DANTE1–32 (for QL1) in the GAIN/PATCH window.

## Output patching

Use the OUTPUT PORT window to patch QL console's output channels and Dante audio network. In this window, assign output channel signals to DANTE 1–64 ports (for QL5) or DANTE 1–32 ports (for QL1).

Next, patch the output signals from DANTE 1–64 (for QL5) or DANTE 1–32 (for QL1) (assigned in the OUTPUT PORT window) to I/O device outputs. Use the OUTPUT PATCH window of the I/O DEVICE to make these assignments.

## QL console internal patching and Dante audio network patching

The following diagram shows the signal flow through the QL series console, I/O devices, and Dante audio network.

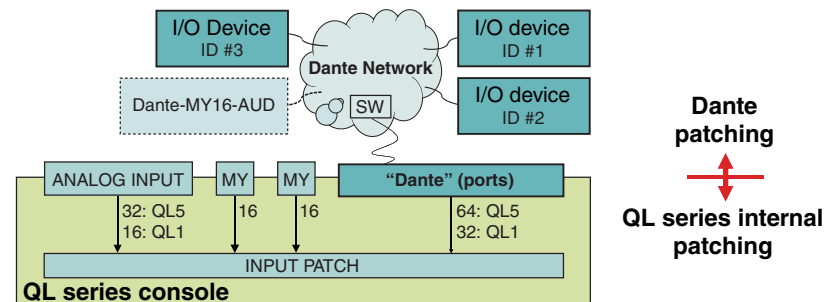

## Changing the input patch settings

### STEP

1. Press the Bank Select keys in the Fader Bank section and the [SEL] keys on the top panel to select the input channel you want to operate.
2. Press the channel number/channel name field on the OVERVIEW screen.
3. Select the type of port in the category select list on the PATCH/NAME screen, and use the port select buttons to select the input port.

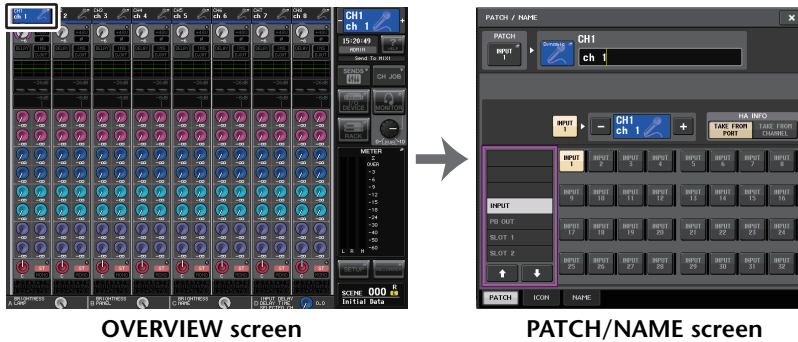

OVERVIEW screen

PATCH/NAME screen

### NOTE

You can also select an input port from the GAIN/PATCH window.

### PATCH/NAME screen



#### ① PATCH button

Indicates the currently-selected input port. If you press this button when selecting an icon or changing the channel name, you will return to the input port select screen.

#### ② Channel icon button

Indicates the icon that is selected for the corresponding channel. When you press this button, a screen will appear in which you can select an icon or sample name.

#### ③ Channel name input box

Indicates the name that is assigned to the corresponding channel. When you press this field, a keyboard window allowing you to change the channel name will appear.



④ **Category select list**

Selects the category of input port. The categories correspond to the following input ports. The displayed categories vary depending on the channel type.

- **DANTE1–32**.....DANTE1–DANTE32
- **DANTE33–64**.....DANTE33–DANTE64 (QL5 only)
- **INPUT/PB OUT**.....INPUT1–32\*1, PB OUT(L), PB OUT(R)
- **SLOT1**.....SLOT1(1)–SLOT1(16)
- **SLOT2**.....SLOT2(1)–SLOT2(16)
- **EFFECT RACK**.....FX1L(A)–FX8R(B)
- **PREMIUM RACK**...PR1L(A)–PR2R(B)

\*1. QL1: INPUT1–16

⑤ **Port select buttons**

Select the input port that is assigned to the currently-selected channel.

⑥ **Tabs**

Enable you to switch between items.

⑦ **Close button**

Closes the screen.

## Changing the output patch settings

To change the patching, you can either select the output port that will be the output destination of each output channel, or you can select the output channel that will be the output source for each output port.

### Selecting the output port for each output channel

#### STEP

1. Press the Bank Select keys in the Fader Bank section and the [SEL] keys on the top panel to select an output channel.
2. Press the channel number/channel name field on the OVERVIEW screen.
3. Select the type of port in the category select list on the PATCH/NAME screen, and use the port select buttons to select the output port.

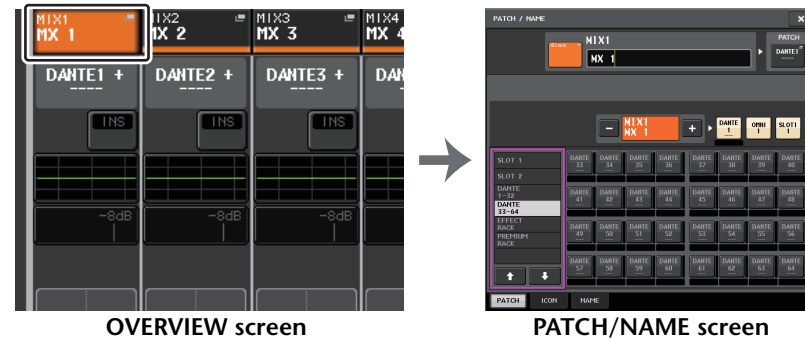

OVERVIEW screen

PATCH/NAME screen

## PATCH/NAME screen

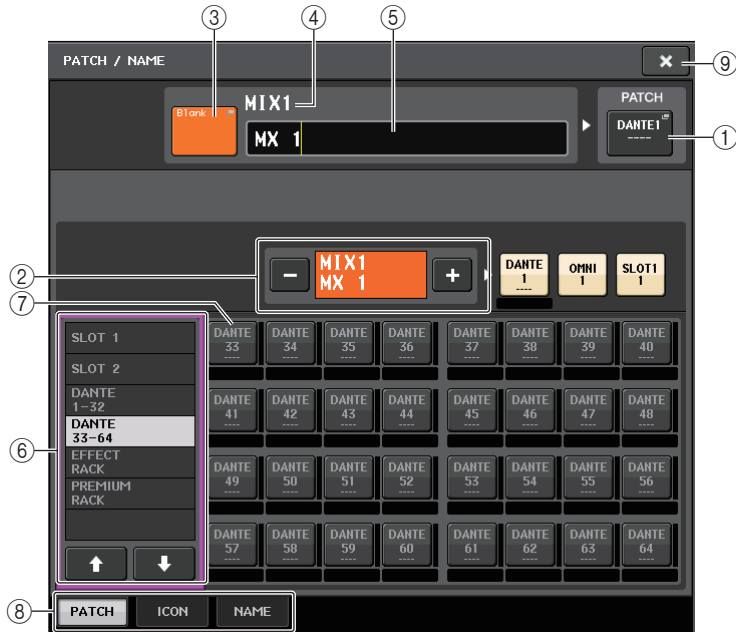

① **PATCH button**

Indicates the port that is patched to the output channel. If you press this button when another tab is active, a window will appear, enabling you to select the network and port.

② **Channel select button**

Selects the channel to set.

**NOTE**

Switching channels on this screen will not affect the channel selection on the console.

③ **Channel icon button**

Indicates the icon and color that are currently selected for the corresponding channel. When you press this button, a screen will appear in which you can select an icon or sample name.

④ **Channel number display box**

Indicates the channel number. This item cannot be changed.

⑤ **Channel name input box**

Indicates the name that is assigned to the corresponding channel. When you press this field, a keyboard window allowing you to assign a name will appear.

⑥ **Category select list**

Select the type of port.

⑦ **Port select buttons**

From the category, these buttons let you select the port to patch. To cancel the selection, press the button once again.

⑧ **Tabs**

Enable you to switch between items.

⑨ **Close button**

Closes the screen.

## Selecting the output channel for each output port

### STEP

1. In the Function Access Area, press the SETUP button.
2. Press the OUTPUT PORT button in the SYSTEM SETUP field located in the center of the SETUP screen.
3. In the tabs below the OUTPUT PORT screen, select the output port you want to control.
4. Press the channel select button of the port you want to operate.
5. Use the category select list and the channel select buttons to select the send-source channel.



SETUP screen

OUTPUT PORT screen

**NOTE**

If PATCH CONFIRMATION in the PREFERENCE tab on the USER SETUP screen is ON, a confirmation dialog box will appear when you attempt to change the patch settings. If STEAL PATCH CONFIRMATION is ON, a confirmation dialog box will appear when you attempt to change a location that is already patched elsewhere.

## CH SELECT screen

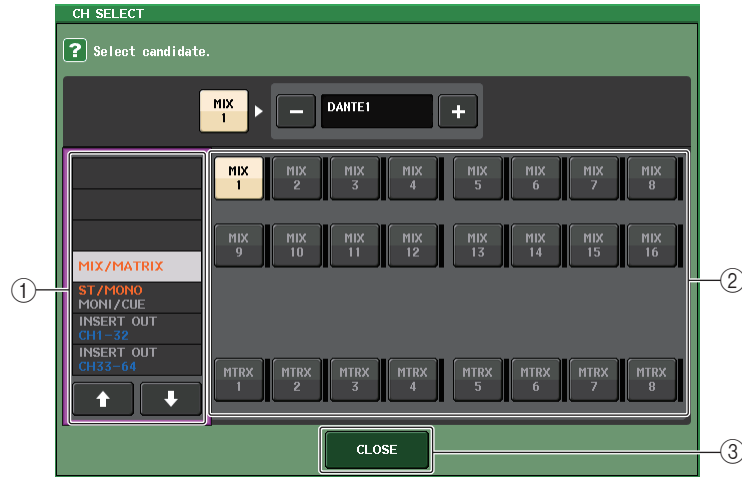

### ① Category select list

Select the category of the channel. The categories correspond to the following channels. They vary depending on the output port type.

- **MIX/MATRIX** ..... MIX1–MIX16, MATRIX1–MATRIX8
- **ST/MONO/MONI/CUE** ..... STEREO L, STEREO R, MONO (C), MONI L, MONI R, MONI C, CUE L, CUE R
- **DIRECT OUT 1–32** ..... CH1–CH32 Direct Outs
- **DIRECT OUT 33–64** ..... CH33–CH64 Direct Outs
- **INSERT 1 OUT 1–32** ..... CH1–CH32 Insert 1 Outs
- **INSERT 1 OUT 33–64** ..... CH33–CH64 Insert 1 Outs
- **INSERT 1 OUT MIX/MATRIX**..... MIX1–MIX16, MATRIX1–MATRIX8 Insert 1 Outs
- **INSERT 1 OUT ST/MONO**..... STEREO L, STEREO R, MONO (C) Insert 1 Outs
- **INSERT 2 OUT 1–32** ..... CH1–CH32 Insert 2 Outs
- **INSERT 2 OUT 33–64** ..... CH33–CH64 Insert 2 Outs
- **INSERT 2 OUT MIX/MATRIX**..... MIX1–MIX16, MATRIX1–MATRIX8 Insert 2 Outs
- **INSERT 2 OUT ST/MONO**..... STEREO L, STEREO R, MONO (C) Insert 2 Outs
- **CASCADE MIX/MATRIX**..... MIX1–MIX16, MATRIX1–MATRIX8
- **CASCADE ST/MONO/CUE** ..... STEREO L, STEREO R, MONO (C), CUE L, CUE R

### NOTE

In the case of QL1, channels that do not exist on the model will not be shown.

### ② Channel select button

Select the channel to be assigned to the output port from the current category.

### ③ CLOSE button

Closes the screen.

## Inserting an external device into a channel

You can insert an effect processor or other external device into the signal path of an INPUT, MIX, MATRIX, STEREO, or MONO channel. When doing so, the type of input/output port used for the insertion and the location of the insertion in/out can be specified individually for each channel.

### STEP

1. Use the Bank Select keys in the Fader Bank section and the [SEL] keys on the top panel to select the channel where you want to insert the external device.
2. Press the popup button in the INSERT field in the SELECTED CHANNEL VIEW screen.
3. Press the INSERT OUT or INSERT IN button.
4. Select an output port or an input port.
5. Press the INSERT ON button.



SELECTED CHANNEL VIEW screen

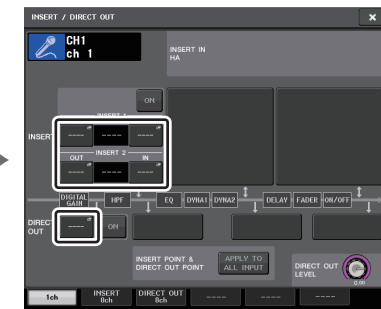

INSERT/DIRECT OUT window (1ch)

### NOTE

If you install a digital I/O card in a slot and digitally connect an external device, you must synchronize the word clock of the QL console and the external device ([page 184](#)).

## INSERT/DIRECT OUT window (1ch)

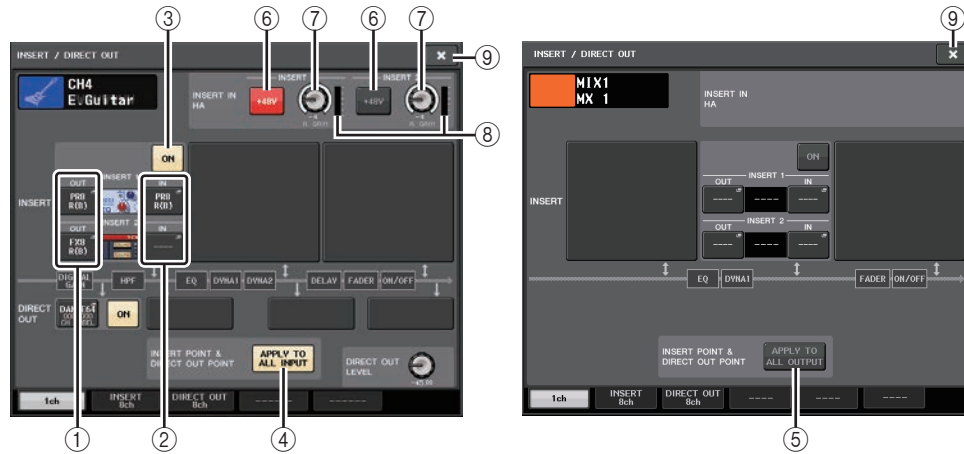

### INSERT field

This field enables you to make insert settings. Press one of three fields to choose PRE HPF (immediately before the HPF), PRE EQ (immediately before the EQ) or PRE FADER (immediately before the fader), or POST ON (immediately after the [ON] key) as the insert position.

- ① **INSERT OUT button**  
Displays the currently-selected output port for insert 1 and insert 2. Press this button to open the PORT SELECT window, and select an output port.
- ② **INSERT IN button**  
Displays the currently-selected input port for insert 1 and insert 2. Press this button to open the PORT SELECT window, in which you can select an input port.
- ③ **INSERT ON/OFF button**  
Switches the insert on or off.
- ④ **APPLY TO ALL INPUT button (input channels only)**  
Specifies whether the insert point/direct out point settings will be applied to all input channels.
- ⑤ **APPLY TO ALL OUTPUT button (output channels only)**  
Specifies whether the insert point setting will be applied to all output channels.

### INSERT IN HA field

This field will appear if you have selected an input port (that features a head amp) as the insert-in.

- ⑥ **+48V button**  
Switches head amp phantom power (+48V) (currently-selected for insert 1 and insert 2) on or off.
- ⑦ **A.GAIN knob**  
Indicates the currently-selected head amp analog gain setting for insert 1 and insert 2. You can use the [TOUCH AND TURN] knob to adjust the gain.

#### NOTE

- If you have selected the INPUT jack on the QL console as the input port for insert-in, make the HA settings in the INSERT IN HA field.
- Even if the INSERT ON/OFF button is OFF, the signal selected for insert-out will continue to be sent.



- ⑧ **HA meter**  
Displays the level of the currently-selected head amp input signal for insert 1 and insert 2.
- ⑨ **Close button**  
Closes the screen.

## INSERT screen (8ch)



- ① **Channel select button**  
Selects the channel to set. The channel icon, color, and number appear.

- ② **INSERT ON/OFF button**  
Switches the insert on or off. The currently-specified insert point setting appears above the button.
- ③ **INSERT OUT button**  
Displays the currently-selected port for insert 1 and insert 2. Press this button to open the PORT SELECT window, in which you can select an output port.
- ④ **INSERT IN button**  
Displays the currently-selected port for insert 1 and insert 2. Press this button to open the PORT SELECT window, in which you can select an input port. You can also view the insert-in level by checking the indicator located to the right of this button.

## PORT SELECT window

Displayed when you press either the INSERT OUT or INSERT IN button in the one-channel or the eight-channel INSERT/DIRECT OUT window. Set the input/output port used for insertion.

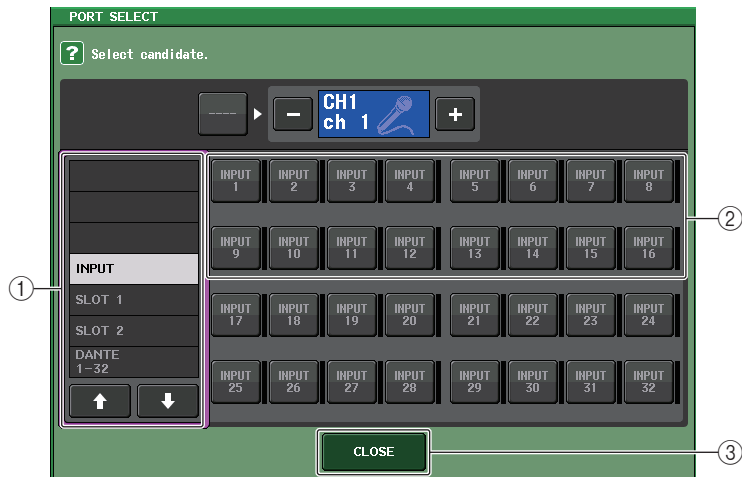

- ① **Category select list**  
Selects the category of port. The categories correspond to the following ports. The displayed categories vary depending on the channel type.
  - DANTE1-32 ..... DANTE1-DANTE32
  - DANTE33-64 ..... DANTE33-DANTE64 (QL5 only)
  - INPUT ..... INPUT1-32 (QL5), INPUT1-16 (QL1) (input channels only)
  - OUTPUT/DIGITAL ..... OMNI OUT1-16, DIGITAL OUT L/R (output channels only)
  - SLOT1 ..... SLOT1(1)-SLOT1(16)
  - SLOT2 ..... SLOT2(1)-SLOT2(16)

- **GEQ RACK** ..... GEQ1L(A)-GEQ8R(B)
  - **EFFECT RACK** ..... FX1L(A)-FX8R(B)
  - **PREMIUM RACK** ..... PR1L(A)-PR8R(B)
- ② **Port select buttons**  
Assign the port that will be used as insert-out/insert-in for the currently-selected channel.
 

**NOTE**  
If a rack in which a GEQ or Premium Rack is mounted is specified as the insert-out or insert-in, the other patch point will automatically be assigned to the same rack. Also, insert mode will automatically be switched on. Additionally, if you defeat the insert-out or insert-in of a rack in which a GEQ or Premium Rack is mounted, the other patch point will automatically be defeated and at the same time insert mode will automatically be switched off.
  - ③ **CLOSE button**  
Closes the screen.

## Directly outputting an INPUT channel

The signal of an INPUT channel can be output directly from an OUTPUT jack on the I/O device, from the desired OMNI OUT jack, or from the output channel of a desired slot.

### STEP

1. Use the Bank Select keys in the Fader Bank section and the [SEL] keys on the top panel to select the INPUT channel that you want to output directly.
2. Press the popup button in the INSERT field in the SELECTED CHANNEL VIEW screen.
3. Press the DIRECT OUT PATCH button in the INSERT/DIRECT OUT window.
4. Select an output port.
5. Press the DIRECT OUT ON button.



SELECTED CHANNEL VIEW screen

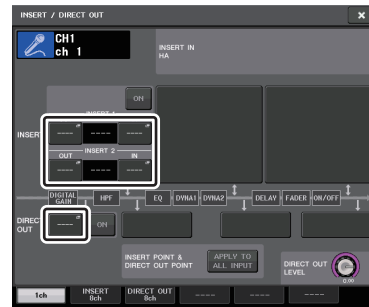

INSERT/DIRECT OUT window (1ch)

### NOTE

If you install a digital I/O card in a slot and digitally connect an external device, you must synchronize the word clock of the QL console and the external device ([page 184](#)).

## INSERT/DIRECT OUT window (1ch)



- 1 **DIRECT OUT field**  
Enables you to make settings for direct output. Press one of four fields to choose PRE HPF (immediately before the HPF), PRE EQ (immediately before the EQ) or PRE FADER (immediately before the fader), or POST ON (immediately after the [ON] key) as the direct output position.
- 2 **DIRECT OUT PATCH button**  
Displays the currently-selected Direct Out output port. Press this button to open the PORT SELECT window, in which you can select an output port.
- 3 **DIRECT OUT ON button**  
Switches the Direct Out on or off.
- 4 **DIRECT OUT LEVEL knob**  
Indicates the output level of the Direct Out. You can use the [TOUCH AND TURN] knob to adjust the level.
- 5 **APPLY TO ALL INPUT button (input channels only)**  
Specifies whether the insert point/Direct Out point settings will be applied to all input channels.
- 6 **Close button**  
Closes the screen.

## DIRECT OUT screen (8ch)



- ① **DIRECT OUT ON button**  
Switches the Direct Out on or off. The currently-selected Direct Out point is indicated above the button.
- ② **DIRECT OUT PATCH button**  
Displays the currently-selected Direct Out output port. Press this button to open the PORT SELECT window, in which you can select an output port.
- ③ **DIRECT OUT LEVEL knob**  
Indicates the output level of the Direct Out. You can use the [TOUCH AND TURN] knob to adjust the level.
- ④ **Close button**  
Closes the screen.

## PORT SELECT window

Displayed when you press the DIRECT OUT PATCH button in the one-channel or the eight-channel INSERT/DIRECT OUT window. Set the output port used for direct output.

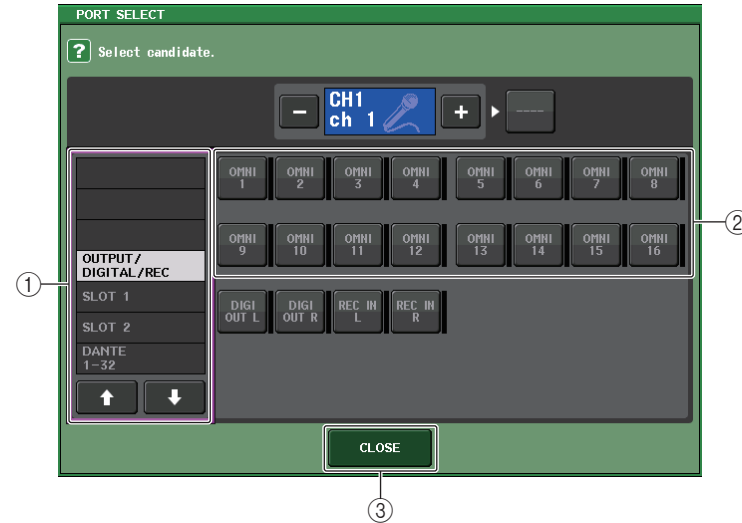

- ① **Category select list**  
Selects the category of output port. The categories correspond to the following output ports. The displayed categories vary depending on the channel type.
  - **OUTPUT/DIGITAL/REC**.....OMNI OUT1–OMNI OUT16 (QL5), OMNI OUT1–OMNI OUT8 (QL1), DIGITAL OUT L/R, RECORDER IN(L/R)
  - **SLOT1**.....SLOT1(1)–SLOT1(16)
  - **SLOT2**.....SLOT2(1)–SLOT2(16)
  - **DANTE1–32**.....DANTE1–DANTE32
  - **DANTE33–64**.....DANTE33–DANTE64 (QL5 only)
- ② **Output port select buttons**  
Assign the output port used for direct output of the currently-selected INPUT channel.
- ③ **CLOSE button**  
Closes the window.



# Input channels

This chapter explains various operations for input channels.

## Signal flow for input channels

The input channels comprise the section that processes signals received from the I/O devices, rear panel input jacks, or slots 1–2, and sends them to the STEREO bus, MONO bus, MIX buses, or MATRIX buses. There are two types of input channels, as follows.

### INPUT channel (monaural)

These channels are used to process monaural signals. When the QL series console is in the default state, the signal from the analog input connector is assigned.

### ST IN channel (stereo)

These channels are used to process stereo signals. When the QL series console is in the default state, the input signals from EFFECT RACKS 5–8 are assigned to ST IN 1–4. There are no assignments for ST IN 5–8.

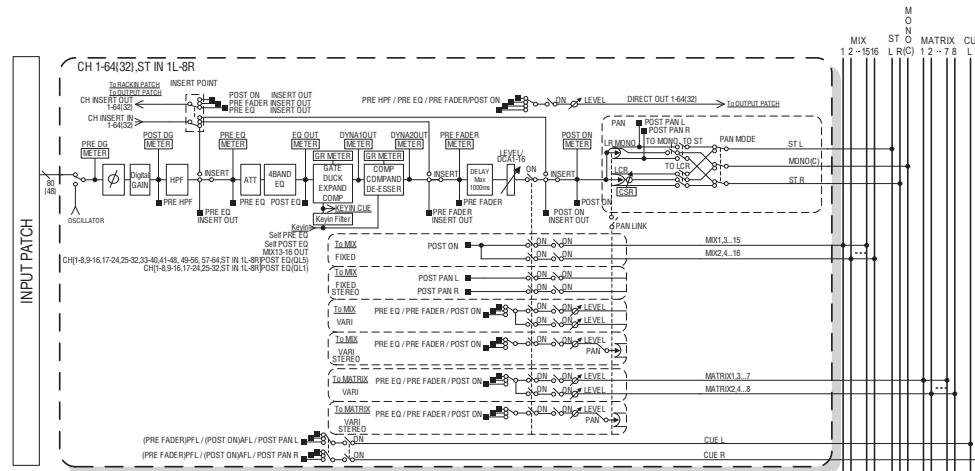

- **INPUT PATCH**  
Assigns input signals to the input channels.
- **∅ (phase)**  
Switches the phase of the input signal.
- **DIGITAL GAIN**  
Attenuates/boosts the level of the input signal.

- **HPF (High Pass Filter)**  
Cuts the region below the specified frequency.
- **4 BAND EQ (4 band equalizer)**  
A parametric EQ with four bands: HIGH, HIGH MID, LOW MID, and LOW.
- **DYNAMICS 1**  
This is a dynamics processor that can be used for gating, ducking, expander, or compressor.
- **DYNAMICS 2**  
This is a dynamics processor that can be used as a compressor, compander, or de-esser.
- **INPUT DELAY**  
Corrects input signal delay. You can specify up to 1000ms.
- **LEVEL/DCA 1–16**  
Adjusts the input level of the effect.
- **ON (On/off)**  
Turns the input channel on or off. If this is off, the corresponding channel will be muted.
- **PAN**  
Adjusts the panning of signals sent from the input channel to the STEREO bus. For the ST IN channel (stereo), you can switch between PAN and BALANCE. The BALANCE parameter adjusts the volume balance of the left/right signals sent from the ST IN channel (stereo) to the STEREO bus. You can turn on PAN LINK in the BUS SETUP window so that the setting of the PAN parameter will also be applied to signals sent to two MIX or MATRIX buses that are set to stereo.
- **LCR (Left/Center/Right)**  
Sends the input channel signal to the STEREO bus/MONO bus as a three-channel signal that consists of the L/R channels plus the center channel.
- **MIX ON/OFF (MIX send on/off)**  
This is an on/off switch for signals sent from the input channel to MIX buses 1–16.
- **MIX LEVEL 1–16 (MIX send levels 1–16)**  
Adjusts the send level of signals sent from the input channel to VARI type MIX buses 1–16. As the position from which the signal is sent to the MIX bus, you can choose from the following: immediately before EQ, pre-fader, or post-fader.
- **MATRIX ON/OFF (MATRIX send on/off)**  
This is an on/off switch for signals sent from the input channel to MATRIX buses 1–8.
- **MATRIX LEVEL 1–8 (MATRIX send levels 1–8)**  
Adjusts the send level of the signal sent from the input channel to MATRIX buses 1–8. As the position from which the signal is sent to the MATRIX bus, you can choose from the following: immediately before the EQ, pre-fader, or post-fader.

- INSERT (INPUT channels (monaural) only)**  
 You can patch the desired output/input ports to insert an external device such as an effect processor. For the position of the insert-out/insert-in point, you can choose immediately before the EQ, immediately before the fader, or immediately after the [ON] key.
- DIRECT OUT (INPUT channels (monaural) only)**  
 You can patch this to any output port to send out the input signal directly from the corresponding output port. For the position of the direct output, you can choose immediately before the HPF, immediately before the EQ, immediately before the fader, or immediately after the [ON] key.
- METER**  
 Indicates the input channel level. You can switch the position at which the level is detected (page 102).

## Specifying the channel name, icon, and channel color

On the QL series unit, you can specify the on-screen name and icon for each input channel. This section explains how to specify the channel name, icon and channel color.

### STEP

- Press the Bank Select keys in the Fader Bank section and the [SEL] keys on the top panel to select the input channel.
- Press the channel number/channel name field of the channel you want to specify on the OVERVIEW screen.
- Switch between items in the tabs on the PATCH/NAME screen, and specify a channel name, icon and channel color.

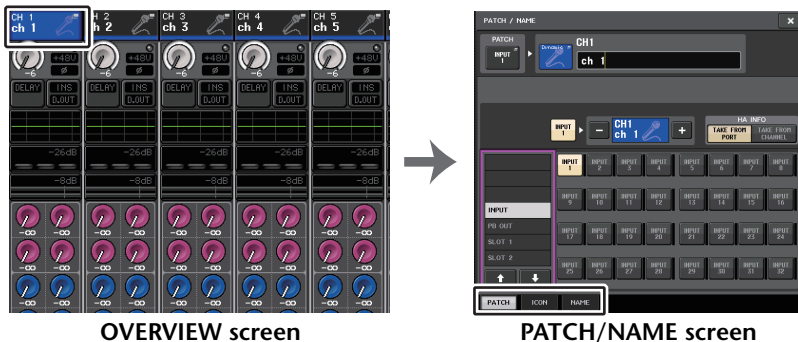

OVERVIEW screen

PATCH/NAME screen

## PATCH/NAME screen

### When selecting the PATCH tab



#### 1 PATCH button

Indicates the currently-patched port. If you press this button when another tab is active, a window will appear, enabling you to select the network and port.

#### 2 Icon button

Indicates the icon and color that are currently selected for the corresponding channel. When you press this button, a screen will appear in which you can select an icon or sample name.

#### 3 Channel name input box

Indicates the currently-specified channel. When you press the inside of this box, the SOFT KEYBOARD window will appear, enabling you to edit the channel name.

#### 4 Tabs

Enable you to switch between items.

#### 5 Close button

Closes the screen.

## ■ When selecting the ICON tab



### ① Channel color select buttons

Select a channel color.

### ② Icon select buttons

Select a channel icon.

### ③ Sample name setup buttons

Select a preset sample name. You can edit the name on the NAME tab later.

#### NOTE

You can also add or edit characters in the channel name field after you have entered the sample name. If you want to quickly assign channel names that consist of a common name plus a consecutive number, such as “Vocal 1” or “Vocal 2,” enter a sample name first, and then add a number.

## ■ When selecting the NAME tab

You can directly enter a channel name on the keyboard screen.



## Making HA (Head Amp) settings

You can make HA (Head Amp) related settings (phantom power on/off, gain, phase) for the input channel.

- To adjust only the HA analog gain, use the [TOUCH AND TURN] knob.

### Setting the gain

Head amp settings are made in the GAIN/PATCH window.

#### STEP

- Press the Bank Select keys in the Fader Bank section and the [SEL] keys on the top panel to select the channel.
- Press the GAIN knob in the GAIN/PATCH field in the SELECTED CHANNEL VIEW screen.
- Press the 1ch or 8ch tab in the GAIN/PATCH window.
- Make settings for the head amp.



SELECTED CHANNEL VIEW screen



GAIN/PATCH window (1ch)

#### NOTE

- The PAD will be switched on or off internally when the HA gain is adjusted between +17 dB and +18 dB.
- Keep in mind that noise may be generated when using phantom power if there is a difference between the Hot and Cold output impedance of an external device connected to the INPUT jack.
- The GAIN knob, +48V button, and Ø button are valid only on channels for which the assigned input port is an INPUT jack on the I/O device, the INPUT jack on the QL unit, or a slot that is connected to an external head amp device (e.g., Yamaha AD8HR or SB168-ES).

## GAIN/PATCH window (1ch)

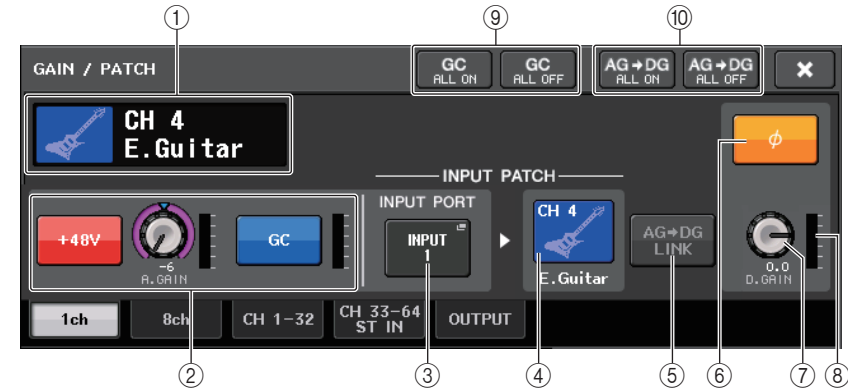

- Channel icon/Channel number/Channel name indicator**

Indicates the channel icon, number, and name.

- HA section**

Appears if the head amp is patched to the input channel.

#### NOTE

- If a slot is patched to the channel, the type of the slot/MY card and the slot meter will be displayed.
- If a rack is patched, the type of rack and type of effect will be displayed.

- +48V button**

Switches head amp phantom power (+48V) on or off.

- A.GAIN (analog gain) knob**

Indicates the analog gain of the head amp. You can use the [TOUCH AND TURN] knob to adjust the gain. If the Gain Compensation function is turned on, an indicator will appear, showing the position of the analog gain when the function is turned on.



- HA meter**

Displays the level of the HA input signal.

- GC (Gain Compensation) ON/OFF button**

Turns the Gain Compensation (gain correction function) on or off. If the Gain Compensation function is turned on, the level of the signal output from the I/O device to the audio network will be stabilized. For example, if the FOH console and the monitoring console are sharing an I/O device, or if you are performing digital recording via Dante connections, using this function will maintain the signal output at a constant level from the I/O device to the network even if the analog gain value on the I/O device is changed. If the Gain Compensation function is turned off, the analog gain and digital gain will return to the level that was obtained when you turned on the function. Therefore, the signal level on the digital network will remain the same.

- Gain compensation meter**

Indicates the level of the signal output to the audio network after gain compensation.

- ③ **INPUT PORT button**  
Indicates the port that is assigned to the channel. Press this button to display the PORT SELECT window, in which you can select a port to patch.
- ④ **Icon/Channel name button**  
Indicates the channel number, icon, and name. Press this button to access the PATCH/NAME window, in which you can patch the input port and specify the channel name.
- ⑤ **AG-DG LINK button**  
Turns the analog gain and digital gain link on or off. When the link is turned on, the digital gain is linked to adjustments made to the analog gain, even if Gain Compensation is on.
- ⑥ **Ø (Phase) button**  
Switches between normal and reverse phase settings of signals input.
- ⑦ **D. GAIN (digital gain) knob**  
Indicates the digital gain value. You can use the [TOUCH AND TURN] knob to adjust the digital gain. If the Gain Compensation function is turned on, no changes will be made to the input level of the analog gain, and therefore the input gain is adjusted with the digital gain.
- ⑧ **Digital gain meter**  
Indicates the level after the signal passes through the digital gain.
- ⑨ **GC ALL ON button/GC ALL OFF button**  
Switch Gain Compensation on or off for all input channels simultaneously.
- ⑩ **AG-DG ALL ON button/AG-DG ALL OFF button**  
Switch all analog gain and digital gain links on or off simultaneously.

## GAIN/PATCH window (8ch)

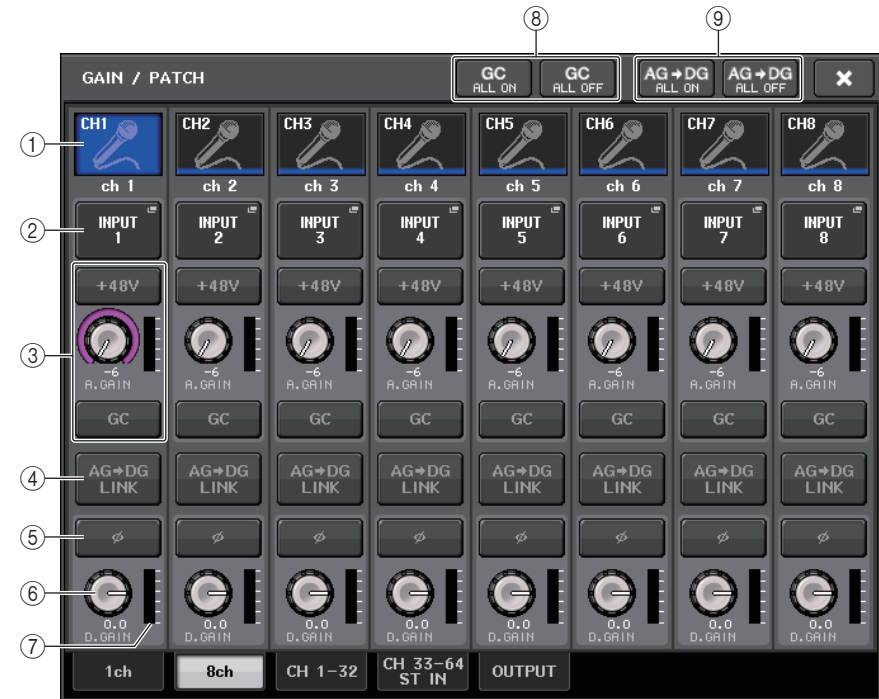

- ① **Channel select button**  
Indicates the channel icon, number, and name. When you press this button, the corresponding channel will become a target for operations in the SELECTED CHANNEL section, and the corresponding [SEL] key will light.

② **PATCH button**

Press this button to display the PORT SELECT window to patch the input port to the input channel.

**PORT SELECT window**

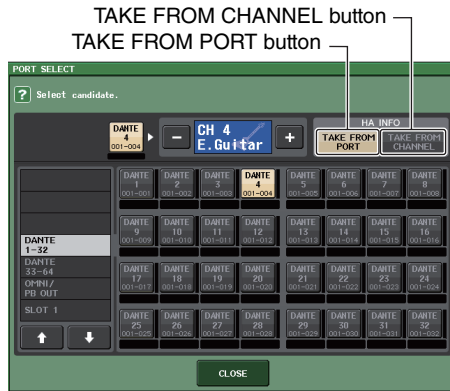

• **TAKE FROM PORT button**

The HA settings of the port will take priority. Even if you change the patching, the HA settings of the port will remain unchanged.

• **TAKE FROM CHANNEL button**

The HA settings of the channel will take priority. The HA settings of the port that had been previously patched will be copied to the newly-patched port.

If the channel's HA settings are selected, the following HA settings will be copied from the channel to the port that is patched. If you patch the input channel from an input that does not have these settings (i.e., that does not have a HA), the default values will be specified.

HA setting	Default value
HA gain amount	-6dB
HPF on/off	Off
Phantom power on/off	Off
Gain compensation on/off	Off

**NOTE**

If you're newly patching a previously-unpatched input channel, the default values will be specified if the HA INFO field's TAKE FROM CHANNEL button is pressed.

③ **HA section**

Appears if the head amp is patched to the input channel.

**NOTE**

If the slot (for which the connection to the head amp is not recognized) is patched, the type of the MY card will be displayed.

• **+48V button**

This button will appear for the input channel to which the head amp has been patched. Press the button to switch phantom power (+48V) on or off.

• **A.GAIN (analog gain) knob**

Indicates the analog gain of the head amp. You can use the [TOUCH AND TURN] knob to adjust the gain. If the Gain Compensation function is turned on, an indicator will appear, showing the position of the analog gain when the function is turned on.



• **Level meter**

Indicates the input signal level.

• **GC (Gain Compensation) button**

Switches the Gain Compensation function on or off for that channel.

④ **AG-DG LINK button**

Turns the analog gain and digital gain link on or off. When the link is turned on, the digital gain is linked to adjustments made to the analog gain, even if Gain Compensation is on.

⑤ **∅ (Phase) button**

Switches between normal and reverse phase settings of signals input.

⑥ **D. GAIN (digital gain) knob**

Indicates the digital gain value. You can use the [TOUCH AND TURN] knob to adjust the gain. If the Gain Compensation function is turned on, digital gain will be used to adjust the level of the signal input to the input channels.

⑦ **Digital gain meter**

Indicates the level after the signal passes through the digital gain.

⑧ **GC ALL ON button/GC ALL OFF button**

Switch Gain Compensation on or off for all input channels simultaneously.

⑨ **AG-DG ALL ON button/AG-DG ALL OFF button**

Switch all analog gain and digital gain links on or off simultaneously.

## GAIN/PATCH window (1–32, 33–64/ST IN (QL5), ST IN (QL1))

This window displays the head amp settings of the corresponding input channels. Here you can also use the [TOUCH AND TURN] knob to adjust the selected head amp gain.

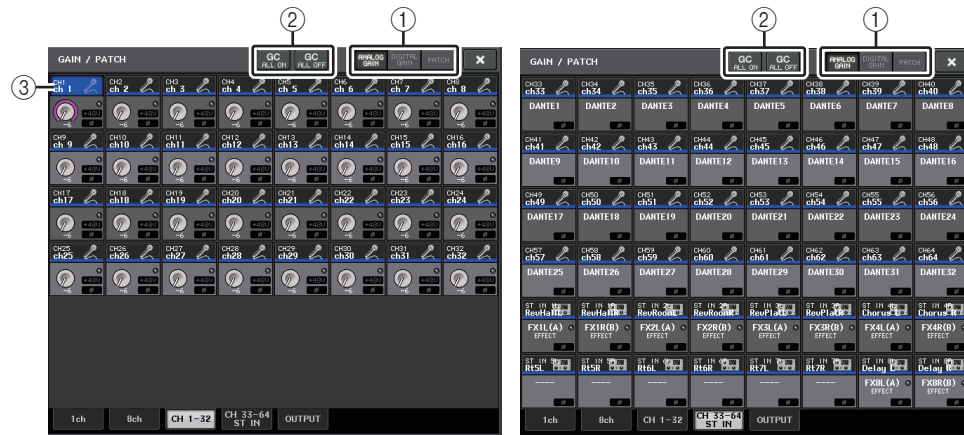

### 1 Parameter select buttons

Switch parameters to view in the window.

- **ANALOG GAIN** ..... Analog gain
- **DIGITAL GAIN** ..... Digital gain
- **PATCH** ..... Patch selection

### 2 GC ALL ON/GC ALL OFF buttons

Switch Gain Compensation on or off for all input channels simultaneously.

### 3 Channel select button

Selects the channel. You can select multiple channels simultaneously.

## ■ If you press the ANALOG GAIN parameter select button:



### 1 GAIN knob

Indicates the analog gain setting for each channel. Press the knob to select a channel, and then control the gain value using the [TOUCH AND TURN] knob. If the Gain Compensation function is turned on, an indicator will appear, showing the position of the analog gain when the function is turned on.

### 2 OVER indicator

Lights when a signal at the input port or from the rack output exceeds the full scale level. This indicator is available only if an input channel is selected.

### 3 +48V indicator

Indicates the +48V on/off status for each channel.

### 4 Ø (Phase) indicator

Indicates the phase setting for each channel.

### NOTE

If the input channel is patched to a slot for which the connection to the head amp is not recognized, the knob 1 will be replaced with the slot/port number of the patch destination. 3 will not be displayed.

If the input channel is patched to a rack, the knob 1 will be replaced with the port ID of the rack. If nothing is patched to the input channel, the knob 1 will be replaced with a dotted line "----".

## ■ If you press the DIGITAL GAIN parameter select button:



### 1 GAIN knob

Indicates the digital gain setting for each channel. Press the knob to select a channel, and then control the gain value using the [TOUCH AND TURN] knob.

### 2 OVER indicator

Lights when a signal at the input port or from the rack output exceeds the full scale level. This indicator is available only if an input channel is selected.

### 3 Ø (Phase) indicator

Indicates the phase setting for each channel.

## ■ If you press the PATCH parameter select button:

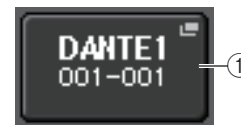

### 1 PATCH button

Press this button to open the PORT SELECT window, in which you can select an input port to patch to the channel.



## Relationship between analog and digital gain while Gain Compensation is on

If Gain Compensation is on, adjusting the analog gain by a specific amount will cause the I/O device to output to the audio network a signal that is attenuated by the same amount. Therefore, the signals on the audio network will maintain a constant corrected level in the digital domain.

For example, assume that the analog gain value has been set to +30 dB and Gain Compensation is now turned on. Under this condition, if you raise the analog gain value to +45 dB, the level of the signal sent to the audio network will stay at +30 dB (that is, attenuated by -15 dB).

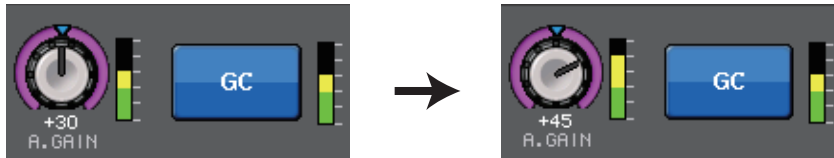

If the FOH console and the monitoring console are sharing one I/O device, adjusting the analog gain on the FOH console will not affect the input level on the monitoring console. The signal in the audio network is maintained at a constant level, and therefore increasing the analog gain as much as possible will lower the relative noise floor and improve the S/N ratio. The gain of each signal input to the QL series unit will be adjusted by the digital gain parameter of the QL series console.

However, please note that if the signal is distorted due to a high level of analog gain, you must first turn the Gain Compensation function off, set the gain to an appropriate input level, and then turn the function back on. If you try to lower the analog gain level while the Gain Compensation function is on, the signal on the audio network will be amplified by the same amount due to the Gain Compensation function, and the signal will remain distorted.

### NOTE

You can perform this operation rapidly if you've assigned Gain Compensation on/off as the SET BY SEL function to one of the USER DEFINED keys.

## Sending the signal from an input channel to the STEREO/MONO bus

The STEREO bus and MONO bus are used to send signals to the main speakers. There are two ways to send signals to the STEREO bus or MONO bus: ST/MONO mode and LCR mode. You can select the mode individually for each channel. These two modes differ as follows.

### ■ ST/MONO mode

This mode sends signals from the input channel to the STEREO bus and to the MONO bus independently.

- Signals sent from an input channel to the STEREO bus and to the MONO bus can be switched on or off individually.
- The panning of a signal sent from an input channel to the STEREO bus L/R is controlled by the TO ST PAN knob. (Signals sent to the MONO bus are not affected by this knob.)
- The left/right volume balance of a signal sent from an ST IN channel to the STEREO bus is controlled by this knob. If PAN/BALANCE mode is set to PAN, you will be able to adjust the pan position of signals sent to the STEREO bus L/R individually ([page 31](#)).

### ■ LCR mode

This mode sends input channel signals to three buses (STEREO (L/R) and MONO (C)) simultaneously.

- Signals sent from an input channel to the STEREO bus and MONO bus will be switched on or off collectively.
- The CSR (Center Side Ratio) knob specifies the level ratio between signals sent from an input channel to the STEREO (L/R) bus and to the MONO (C) bus.
- The TO ST PAN knob/BALANCE knob specifies the level of signals sent from an input channel to the STEREO (L/R) bus and MONO (C) bus.

### NOTE

If you want to monitor the signal of the STEREO bus or MONO bus through headphones or similar devices, press the MONITOR button in the Function Access Area to select "LCR" as the monitor source before you continue with the following procedure.

**STEP**

1. Set the phantom power, gain, and phase of the input channel from which you want to send the signal to the STEREO/MONO bus.
2. Press the Bank Select keys in the Fader Bank section and the [SEL] keys on the top panel to select the input channel from which you want to send the signal to the STEREO/MONO bus.
3. In the PAN/BALANCE field, press a knob to select the channel you want to adjust in the SELECTED CHANNEL VIEW screen, and then press the knob once again.
4. Use the MODE select button in the TO STEREO/MONO window to select either ST/MONO mode or LCR mode for each channel.
5. In the MASTER section on the top panel, turn on the [ON] key for the ST IN channel (stereo)/INPUT channel (monaural), and then raise the fader to an appropriate level.
6. In the INPUT section on the top panel, turn on the [ON] key for the input channel you want to control, and then raise the fader to an appropriate position.

The subsequent steps will differ depending on whether ST/MONO mode or LCR mode was selected for the channel in step 4.

**Channels for which ST/MONO mode is selected**

7. In the TO STEREO/MONO window, use the STEREO/MONO button to individually turn on/off the signal sent from the input channel to the STEREO bus/MONO bus.
8. Use the TO ST PAN knob to set the panning of a signal sent from the input channel to the STEREO bus.

**Channels for which LCR mode is selected**

7. In the TO STEREO/MONO window, use the LCR button to turn signals sent from the input channel to the STEREO bus/MONO bus on or off collectively.
8. Use the CSR knob to adjust the level difference between signals sent from that channel to the STEREO (L/R) bus and to the MONO (C) bus.
9. Use the TO ST PAN knob to specify the panning of signals sent from the input channel to the STEREO (L/R) bus and MONO (C) bus.



SELECTED CHANNEL VIEW screen



TO STEREO/MONO window

**TO STEREO/MONO window (8ch)**

Here you can control the on/off and pan/balance settings of signals sent from input channels to the STEREO (L/R) bus and MONO (C) bus, in groups of eight channels.

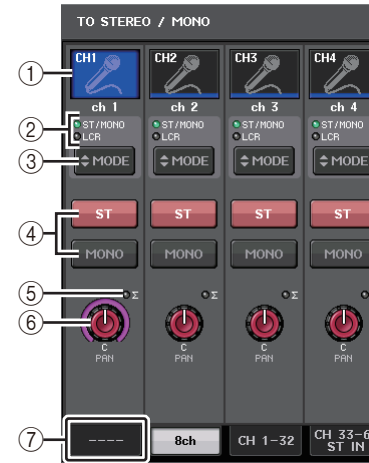

ST/MONO mode



LCR mode

- 1 **Channel select button**  
Selects the channel. You can select multiple channels simultaneously.
- 2 **Mode LEDs**  
The LED of the currently-selected mode will light.
- 3 **MODE select button**  
For an INPUT channel (monaural), the mode can be switched between ST/MONO and LCR. For a STEREO channel, the mode can be switched between PAN and BALANCE.
- 4 **ST/MONO buttons**  
These buttons are on/off switches for signals that are sent from each channel to the STEREO bus/MONO bus when the MONO button is set to ST/MONO mode.
- 5 **Σ clipping indicator**  
Lights to indicate a signal is clipping at some point in the channel.

### ⑥ TO ST PAN/TO ST BALANCE knob

For an INPUT channel (monaural), this acts as a PAN knob that adjusts the left/right panning of signals sent to the STEREO bus. For a ST IN channel (stereo), this acts as a PAN knob, and also as a BALANCE knob that adjusts the volume of the left and right signals sent to the STEREO bus. To adjust the value, press the knob to select it, and then operate the [TOUCH AND TURN] knob.

### ⑦ Tabs

Enable you to switch between windows.

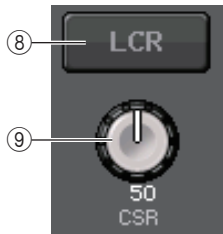

### ⑧ LCR button

If the MODE button is set to LCR mode, this button is displayed instead of ④. This button is an overall on/off button for signals sent from a channel to the STEREO bus and MONO bus. If this button is off, no signals will be sent from the corresponding input channel to the STEREO bus or MONO bus.

### ⑨ CSR knob

Adjusts the relative level of signals sent from the channel to the STEREO (L/R) bus and to the MONO (C) bus, in the range of 0–100%. To adjust the value, press the knob to select it, and then operate the [TOUCH AND TURN] knob ([page 33](#)).

## TO STEREO/MONO window (CH1–32, CH33–64/ST IN (QL5), ST IN (QL1))

Adjusts the status of a signal sent from the corresponding input channel to the STEREO/MONO bus. You can also adjust the selected pan or balance setting.

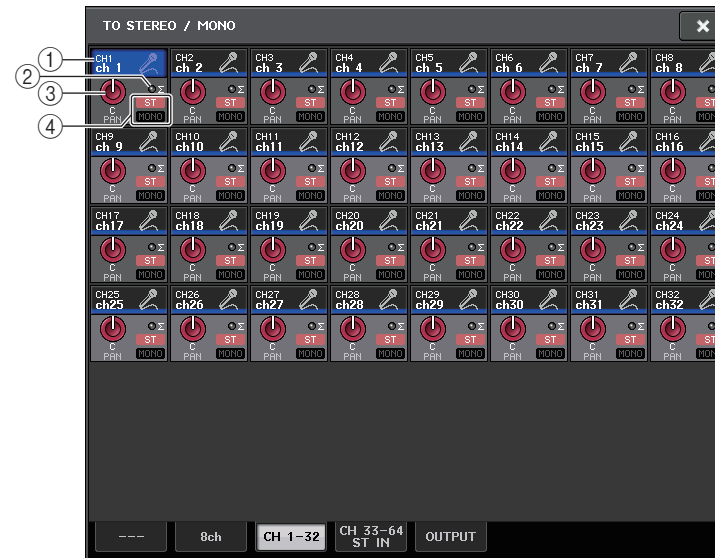

### ① Channel select button

Selects the channel. You can select multiple channels simultaneously.

### ② $\Sigma$ clipping indicator

Lights to indicate a signal is clipping at some point in the channel.

### ③ TO ST PAN/TO ST BALANCE knob

Adjusts the panning or balance.

To adjust the value, press the knob to select it, and then operate the [TOUCH AND TURN] knob.

If the signal reaches the overload point at any meter detection point in that channel, the  $\Sigma$  indicator to the right of the knob will light.

### ④ ST/MONO indicator

If a channel is set to ST/MONO mode, these indicators will individually indicate the on/off status of signals sent from the channel to the STEREO bus/MONO bus.

If that channel is set to LCR mode, the LCR indicator will be displayed in this location. The LCR indicator indicates the on/off status of all signals sent from that channel to the STEREO bus/MONO bus.

### Signal level when LCR mode is selected

If LCR mode is selected, the signal level sent to the STEREO (L/R) bus and MONO (C) bus will vary according to the settings of the CSR knob and the TO ST PAN knob.

#### ■ When the CSR knob is set to 0% (INPUT channel (monaural))

The TO ST PAN knob operates as a conventional PAN knob, and no signal is sent to the MONO (C) bus.

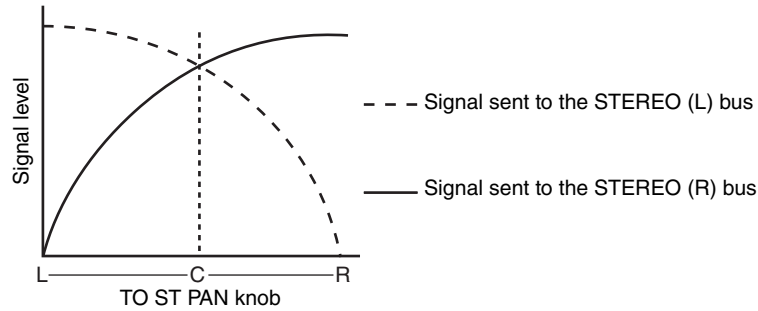

#### ■ When the CSR knob is set to 0% (ST IN channel (stereo))

The TO ST BALANCE knob operates as a conventional BALANCE knob, and no signal is sent to the MONO (C) bus.

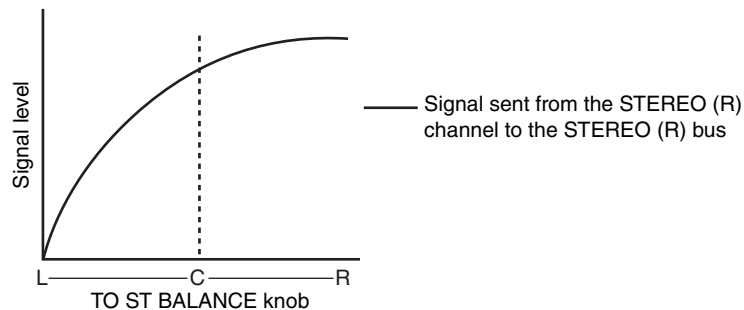
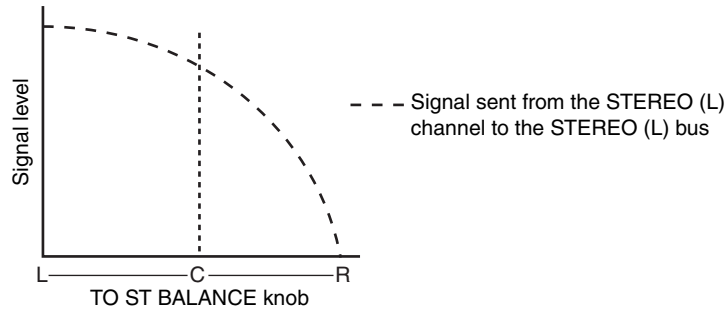

#### ■ When the CSR knob is set to 100%

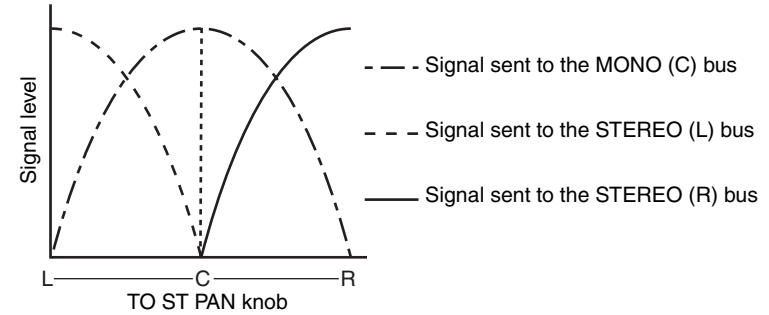

#### ■ When the CSR knob is set to 100% (ST IN channel)

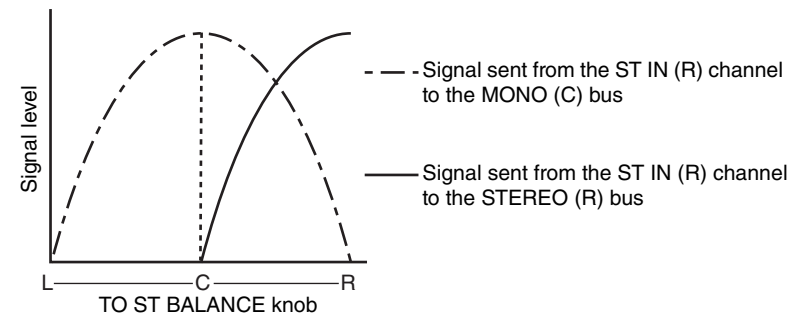
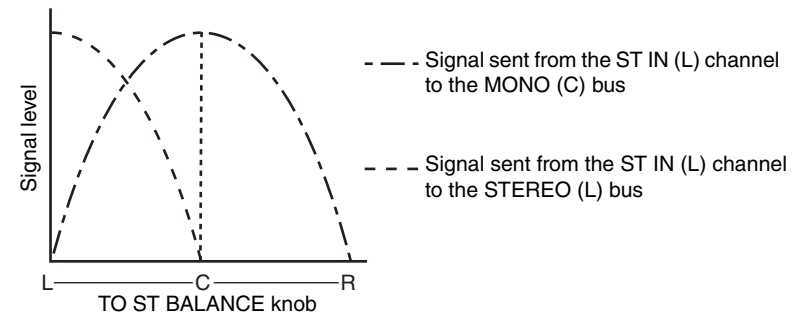

## Sending a signal from an input channel to a MIX/MATRIX bus

The MIX buses are used mainly for the purpose of sending signals to foldback speakers on stage, or to external effect processors. The MATRIX buses are used to produce a mix that is independent of the STEREO bus or MIX buses, and is typically sent to a master recorder or to a backstage monitoring system.

You can send a signal from an input channel to a MIX/MATRIX bus in the following ways.

### ■ Using the SELECTED CHANNEL section

With this method, you use the [TOUCH AND TURN] knob to adjust the send levels to the MIX/MATRIX buses. When using this method, signals sent from a specific input channel to all MIX/MATRIX buses can be adjusted collectively.

### ■ Using the faders (SENDS ON FADER mode)

With this method, you switch the QL series unit to SENDS ON FADER mode, and use the faders on the top panel to adjust the level of signals sent to the MIX/MATRIX buses. When using this method, signals sent from all input channels to a specific MIX/MATRIX bus can be adjusted simultaneously.

## Using the SELECTED CHANNEL section

This section explains how to use the [TOUCH AND TURN] knob to adjust the send levels of signals sent from a specific input channel to all MIX/MATRIX buses.

### STEP

1. Press the Bank Select keys in the Fader Bank section and the [SEL] keys on the top panel to select the input channel from which you want to send the signal to the MIX/MATRIX buses.
2. Turn on the ON button in the SEND field in the SELECTED CHANNEL VIEW screen.
3. Use the [TOUCH AND TURN] knob to adjust the send levels to the MIX/MATRIX buses.



SELECTED CHANNEL VIEW screen

MIX buses can be either a FIXED type that features a fixed send level, or a VARI type that features a variable send level. The MATRIX buses are all VARI type. You can switch between FIXED and VARI types for each two adjacent odd/even-numbered MIX buses. To do so, press the SETUP button and then the BUS SETUP button to open the BUS SETUP window.

### ■ If the MIX bus is a FIXED type



A gray circle is displayed instead of the TO MIX SEND LEVEL knob, and you cannot adjust the send level.

### ■ For a VARI type MIX bus or a MATRIX bus



Use the [TOUCH AND TURN] knob to adjust the send level.

## ■ If the MIX/MATRIX bus is a stereo bus



You can link the main parameters of two adjacent odd/even-numbered MIX/MATRIX buses. If the send-destination MIX/MATRIX bus is assigned as stereo, the left knob of the two adjacent TO MIX/MATRIX SEND LEVEL knobs will operate as the TO MIX/MATRIX PAN knob. (If BALANCE mode is selected in the TO STEREO/MONO window, it will operate as a BALANCE knob).

### NOTE

- For an INPUT channel (monaural), the right knob will adjust the common send level to the two MIX/MATRIX buses, and the left knob will adjust the panning between the two MIX/MATRIX buses. Rotating the left TO MIX/MATRIX SEND PAN knob counter-clockwise will increase the amount of signal sent to the odd-numbered MIX/MATRIX bus, and rotating it clockwise will increase the amount sent to the even-numbered MIX/MATRIX bus.
- For a ST IN channel (stereo), if BALANCE mode has been selected in the TO STEREO/MONO window (8ch), the right knob adjusts the common send level for the two MIX/MATRIX buses, and the left knob adjusts the volume balance of the left and right signals sent to the two MIX/MATRIX buses. Rotating the left TO MIX/MATRIX SEND BAL knob counter-clockwise will increase the amount of signal sent from the L-channel to the odd-numbered MIX/MATRIX bus, and rotating it clockwise will increase the amount sent from the R-channel to the even-numbered MIX/MATRIX bus. If PAN mode has been selected in the TO STEREO/MONO window (8ch), the left knob will function as the PAN knob. The right knob will function as send level, just as in BALANCE mode.

## MIX SEND/MATRIX SEND window

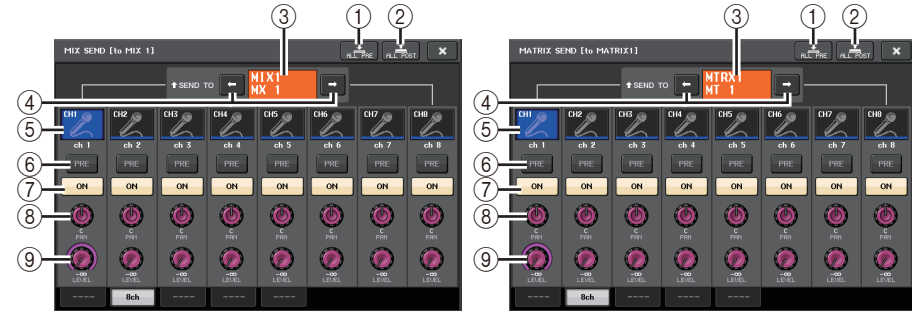

- ① **ALL PRE button**  
Sets the send point to PRE. (The send point is the point at which signals are sent from all send-source channels — including the input and output channels — to the selected send destination.) At this time, the PRE/POST button will light.
  - ② **ALL POST button**  
Sets the send point to POST. (The send point is the point at which signals are sent from all send-source channels — including the input and output channels — to the selected send destination.) At this time, the PRE/POST button will turn off.
  - ③ **Send destination indicator**  
Indicates the currently-selected send destination.
  - ④ **Send destination select buttons**  
Select MIX/MATRIX buses as the send destination.
  - ⑤ **Channel select button**  
Selects the send-source channel that you wish to control. The current channel icon, number, and color appear on the button, and the channel name appears below the button.
  - ⑥ **PRE/POST button**  
Switches the send point of each send-source channel between PRE and POST. If the button is lit, the send point is set to PRE.
- NOTE**
- If the PRE/POST button is on, you can also select PRE EQ (immediately before the EQ) or PRE FADER (immediately before the fader) for each MIX/MATRIX bus. This setting is made in the BUS SETUP window ([page 189](#)).
  - The PRE/POST button is not displayed for FIXED type MIX buses.
- ⑦ **SEND ON/OFF button**  
Switches the send of each send-source channel on or off.

**⑧ SEND PAN/BALANCE knob**

Sets the panning or balance of signals sent to the stereo send destination. If the send destination is monaural or set to FIXED, this knob will not appear.

If the send source is monaural, this knob functions as a PAN knob.

If the send source is stereo, you can use PAN/BALANCE mode setting in the TO STEREO/MONO window to select whether PAN/BALANCE will function as a PAN or BALANCE knob. The knob for the mode selected here will appear.

**⑨ SEND LEVEL knob**

Indicates the level of signals sent to the selected send destination. You can use the [TOUCH AND TURN] knob to control the level.

If the send destination is set to FIXED, only a gray circle will appear.

**Using the faders (SENDS ON FADER mode)**

You can use the faders on the top panel to adjust signals that are sent from all input channels to a specific MIX/MATRIX bus.

**STEP**

1. Assign an output port to each MIX/MATRIX bus to which you want to send signals, and connect your monitor system, external effects, or other device to the corresponding output port.
2. In the Function Access Area, press the SENDS ON FADER button, or press the key that is currently lit in the SENDS ON FADER section.
3. Use the MIX/MATRIX select buttons in the Function Access Area to switch between MIX/MATRIX.
4. Use the MIX/MATRIX bus select buttons in the Function Access Area, or the key in the SENDS ON FADER section to select the send-destination MIX/MATRIX bus.
5. Use the faders in the Channel Strip section on the top panel to adjust the send level of signals routed from the input channels to the selected MIX/MATRIX bus.



**SENDS ON FADER section**



**Function access area**

**NOTE**

- Press the SENDS ON FADER button to switch to SENDS ON FADER mode. The faders in the Channel Strip section and Master section will move to the send levels of the signals that are routed from each channel to the currently-selected MIX/MATRIX bus. The [ON] keys will also change to the SEND ON status.
- If you press the currently-selected MIX/MATRIX bus select button again, cue monitoring will be turned on for the related MIX/MATRIX channel. This method is convenient if you want to monitor the signal that is being sent to the selected MIX/MATRIX bus.
- You can assign the SENDS ON FADER function to a USER DEFINED key. This lets you quickly switch to SENDS ON FADER mode for a specific MIX/MATRIX bus, and quickly switch back again.



## SENDS ON FADER mode



## ① MIX/MATRIX select button

Use the MIX/MATRIX select button to switch between MIX/MATRIX for the bus displayed in the Function Access Area.

## ② MIX/MATRIX bus select buttons

Select the buses that will be controlled by the faders.

## ③ Close button

Closes the SENDS ON FADER mode.

## Correcting delay between channels (Input Delay)

This section explains how to correct delay between input channels by using the Input Delay function.

This function is useful when you want to correct the phase variance caused by microphone locations on the stage, to add depth to the sound by using phase variance, or to correct a delay (a time gap) that may exist between video and audio that are sent from a site for broadcast on TV.

## STEP

1. Press the Bank Select keys in the Fader Bank section and the [SEL] keys on the top panel to select the input channel.
2. Press the INPUT DELAY field in the SELECTED CHANNEL VIEW screen.
3. Use the [TOUCH AND TURN] knob to set the delay.
4. Press the DELAY ON button.



SELECTED CHANNEL VIEW screen



INPUT DELAY screen

## INPUT DELAY window (8ch)

You can set the on/off status and the value of the input channel delay.



### ① DELAY SCALE button

Press the button to display the DELAY SCALE window, in which you can select the unit for the delay time. There are four delay scales: meter (meter/sec), feet (feet/sec), sample (number of samples), and ms (millisecond).

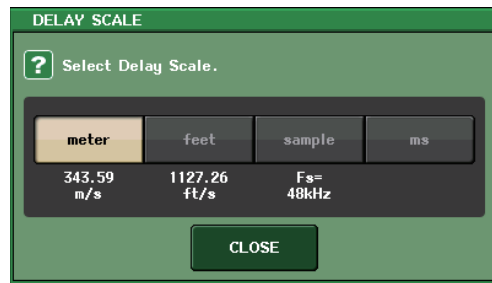

### ② Channel select button

The currently-selected input channel is indicated in blue. Press the button to select the channel.

### ③ Delay setting knob (input channels only)

Use the [TOUCH AND TURN] knob to set the delay value. You can view the current value immediately above the knob (always shown in unit of ms) and below the knob (shown using the currently-selected scale). If ms (millisecond) has been selected for the DELAY SCALE, nothing will appear above the knob.

### ④ DELAY ON button

Switches the delay on or off.

### ⑤ Tabs

Enable you to switch between windows.

### ⑥ Close button

Closes the window.

## INPUT DELAY (CH1–32, CH33–64/ST IN (QL5), ST IN (QL1))

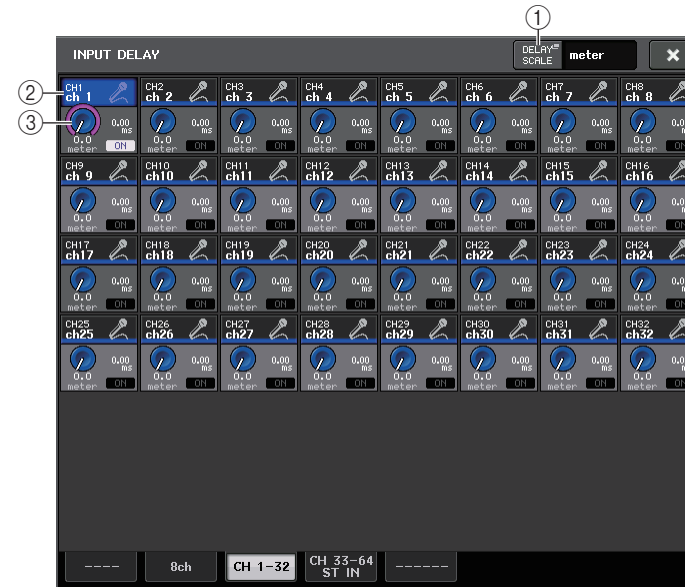

### ① DELAY SCALE button

Press the button to display the DELAY SCALE window, in which you can select the unit for the delay time.

### ② Channel select button

Lights to indicate the currently-selected input channel. Press the button to select the channel.

### ③ Delay setting knob (input channels only)

Use the [TOUCH AND TURN] knob to set the value. You can view the current value immediately beside the knob (always shown in unit of ms) and below the knob (shown using the currently-selected scale).

### NOTE

If ms (millisecond) has been selected for the DELAY SCALE, nothing will appear to the right of the knob.

## Channel library operations

Channel libraries include “INPUT CHANNEL LIBRARY,” which enables you to store and recall various parameters (including the head amp settings) for input channels.

To recall a library, press the corresponding LIBRARY button in the SELECTED CHANNEL VIEW screen. For details on using the library, refer to the “Using the libraries” section in the separate Owner’s Manual.

LIBRARY button



# OUTPUT channels

This chapter explains output channels (MIX channels, MATRIX channels, STEREO channels, MONO channels).

## Signal flow for output channels

The output channel section takes the signals sent from the input channels to the various buses, processes them with EQ and dynamics, and sends them to output ports or other buses. The following types of output channels are provided.

### MIX channels

These channels process signals sent from input channels to MIX buses, and output them to the corresponding output port, MATRIX bus, STEREO bus, or MONO (C) bus.

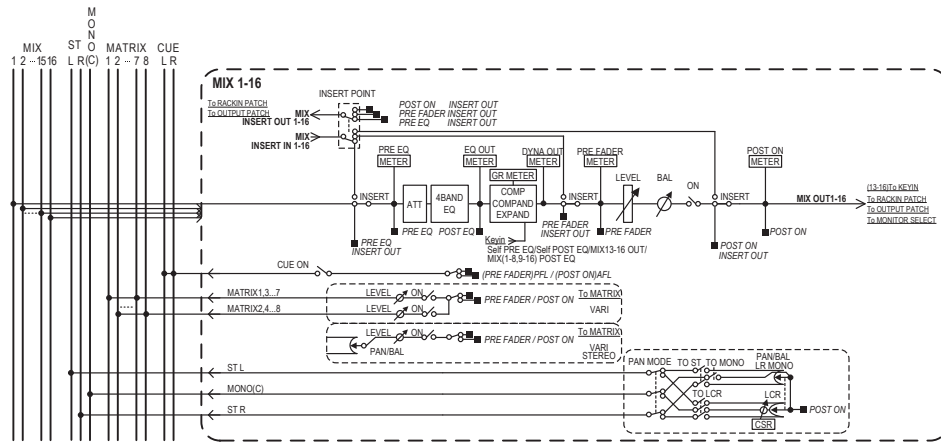

### STEREO channel/MONO (C) channel

Each of these channels processes the signal sent from the input channels to the STEREO bus or MONO (C) bus, and send it to the corresponding output port or MATRIX bus. If input channels are in LCR mode, the STEREO (L/R) channels and the MONO (C) channel can be used together as a set of three output channels.

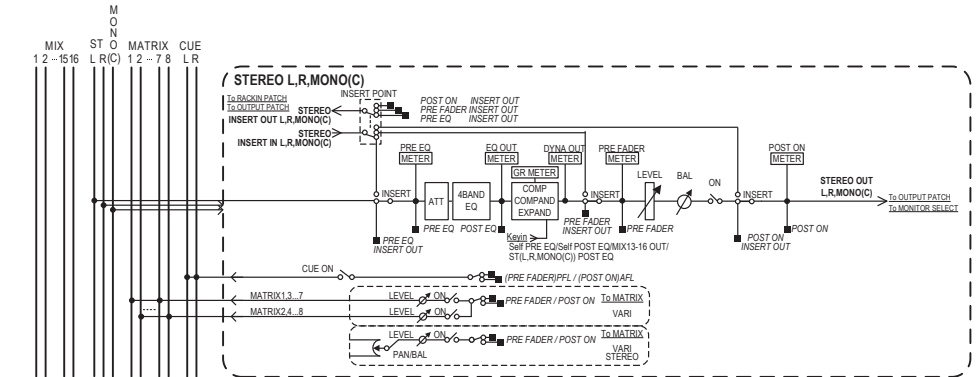

### MATRIX channel

These channels process the signals sent from input channels, MIX channels, and STEREO/MONO channels to MATRIX buses, and send them to the corresponding output ports.

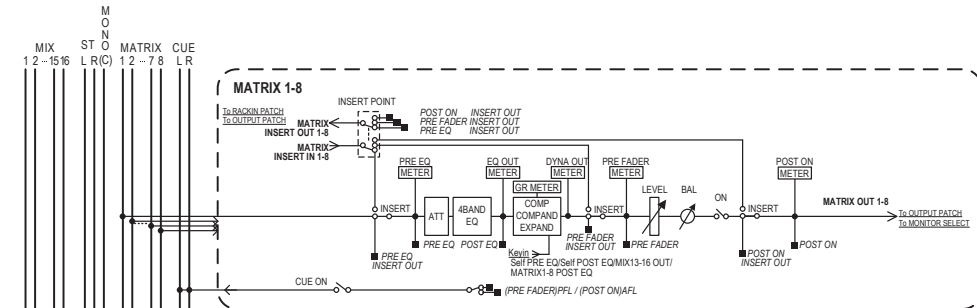

- 4 BAND EQ (4 band equalizer)**  
 A parametric EQ with four bands: HIGH, HIGH MID, LOW MID, and LOW.
- DYNAMICS 1**  
 This is a dynamics processor that can be used as a compressor, expander, or compander.
- LEVEL**  
 Adjusts the output level of the channel.
- ON (On/off)**  
 Turns the output channel on or off. If this is off, the corresponding channel will be muted.

- MATRIX ON/OFF (MATRIX send on/off)**  
 This is an on/off switch for signals sent from the MIX channels, STEREO (L/R) channel, or MONO (C) channel to each MATRIX bus.
- MATRIX (MATRIX send level)**  
 Adjusts the send level of signals sent from the MIX channels, STEREO (L/R) channel, or MONO (C) channel to each MATRIX bus 1–8. For the position from which the signal will be sent to the MATRIX bus, you can choose either immediately before the fader, or immediately after the [ON] key.
 

If the send-destination MATRIX bus is set to stereo, you can use the PAN knob to adjust the panning between the two MATRIX buses. If the send-source is a stereo MIX channel or the STEREO channel, use the BALANCE knob to adjust the volume balance of the left and right channels sent to the two MATRIX buses.
- INSERT**  
 You can patch the desired output/input ports to insert an external device such as an effect processor. You can switch the insert-out and insert-in locations.
- METER**  
 Indicates the level of the output channel.  
 You can switch the position at which the level is detected.
- KEY IN (MIX channels 13–16 only)**  
 You can send the output signals of MIX channels 13–16 to dynamics processors and use them as key-in signals to control the dynamics.
- RACK IN PATCH**  
 Patches the output signal of an output channel to an input of the rack.
- OUTPUT PATCH**  
 Assigns an output port to an output channel.
- MONITOR SELECT**  
 Selects the output signal of an output channel as a monitor source.

## Specifying the channel name, icon, and channel color

### STEP

- Press the Bank Select keys in the Fader Bank section and the [SEL] keys on the top panel to select an output channel.
- In the OVERVIEW screen, press the channel number/channel name field of the channel for which you want to specify the channel name, icon, and channel color.
- Follow the steps for the input channels ([page 24](#)).

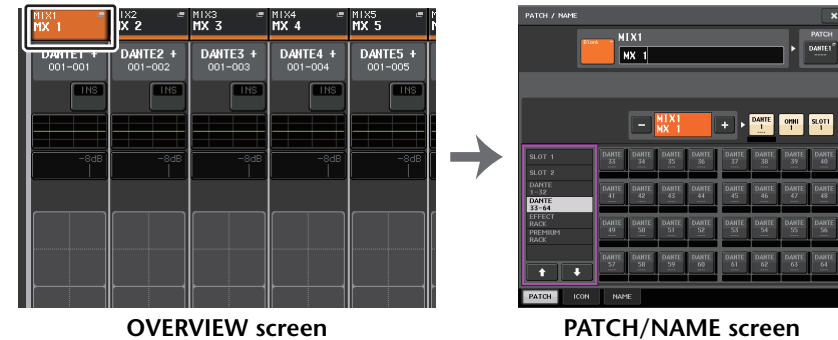

OVERVIEW screen

PATCH/NAME screen

# Sending signals from MIX channels to the STEREO/MONO bus

There are two ways to send signals to the STEREO bus or MONO bus: ST/MONO mode and LCR mode. You can select the mode individually for each channel. Features of each mode are the same as for input channels.

## STEP

1. Use the Bank Select keys in the Fader Bank section and the [SEL] keys on the top panel to select the MIX channel from which you want to send the signal to the STEREO/MONO bus.
2. In the PAN/BALANCE field, press a knob to select the channel you want to adjust in the SELECTED CHANNEL VIEW screen, and then press the knob once again.
3. Use the MODE select button in the TO STEREO/MONO window to select either ST/MONO mode or LCR mode for each channel.
4. In the MASTER section on the top panel, turn on the [ON] key for the STEREO channel/MONO channel, and then raise the fader to an appropriate level.
5. Turn on the [ON] keys for those channels, and use the fader in the Channel Strip section to raise the master level of the MIX channel to an appropriate position.

The subsequent steps will differ depending on whether ST/MONO mode or LCR mode was selected for the channel in step 3.

### Channels for which ST/MONO mode is selected

6. In the TO STEREO/MONO window, use the ST/MONO button to turn a signal sent from the MIX channel to the STEREO bus/MONO bus on or off.
7. Use the TO ST PAN knob to set the panning of the signal sent from the MIX channel to the STEREO bus.

### Channels for which LCR mode is selected

6. Turn on the LCR button in the TO STEREO/MONO window.
7. Press the CSR knob to select it, and use the [TOUCH AND TURN] knob to adjust the level difference between signals sent from that channel to the STEREO (L/R) bus and to the MONO (C) bus.
8. Press the TO ST PAN knob to select it, and use the [TOUCH AND TURN] knob to adjust the panning of signals sent from the MIX channel to the STEREO (L/R) bus and MONO (C) bus, and the level balance of signals sent to the MONO (C) bus and STEREO (L/R) bus.



SELECTED CHANNEL VIEW screen

TO STEREO/MONO window

## NOTE

Refer to “Signal level when LCR mode is selected” on page 33 for details on how the signal level sent from an LCR mode MIX channel to each bus will change according to the operation of the TO ST PAN knob.

## TO STEREO/MONO window (8ch)

You can control the on/off and pan/balance settings of the signal sent from MIX channels to the STEREO (L/R) bus and MONO (C) bus, in groups of eight channels.



ST/MONO mode

LCR mode

- ① **Channel select button**  
Selects the channel. You can select multiple channels simultaneously.
- ② **Mode LEDs**  
The LED of the currently-selected mode will light.

③ **MODE select button**

Press this button repeatedly to toggle between ST/MONO and LCR.

④ **ST/MONO buttons**

These buttons are individual on/off switches for signals that are sent from each channel to the STEREO bus/MONO bus when the MONO button is set to ST/MONO mode.

⑤ **Σ clipping indicator**

Lights to indicate a signal is clipping at some point in the channel.

⑥ **TO ST PAN/TO ST BALANCE knob**

If the type of the MIX channel signal is MONO, this knob will function as a PAN knob that adjusts the left and right pan position of the signal sent to the STEREO bus. If the type of MIX channel signal is STEREO, this knob will function as a BALANCE knob that adjusts the volume level balance of left and right signals sent to the STEREO bus. To adjust the value, press the knob to select it, and then operate the [TOUCH AND TURN] knob.

⑦ **Tabs**

Enable you to switch between windows.

⑧ **LCR button**

This button is an overall on/off button for signals sent from a channel to the STEREO bus and MONO bus. If this button is off, no signals will be sent from the corresponding input channel to the STEREO bus or MONO bus.

⑨ **CSR knob**

Adjusts the relative level of signals sent from the channel to the STEREO (L/R) bus and to the MONO (C) bus, in the range of 0–100%. To adjust the value, press the knob to select it, and then operate the [TOUCH AND TURN] knob.

**TO STEREO/MONO window**

**(CH1–32, CH33–64/ST IN (QL5), ST IN (QL1), OUTPUT)**

This window shows the status of signals sent from the corresponding channel to the STEREO bus/MONO bus. You can also adjust the selected pan or balance setting.

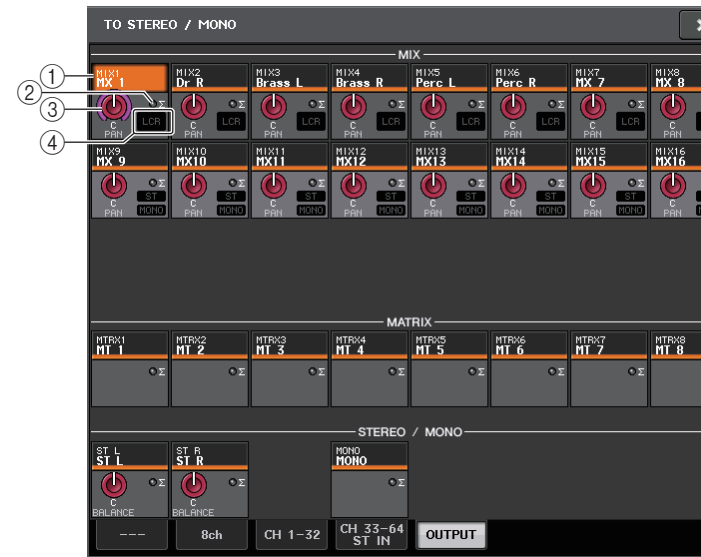

① **Channel select button**

Selects the channel. You can select multiple channels simultaneously.

② **Σ clipping indicator**

Lights to indicate a signal is clipping at some point in the channel.

③ **TO ST PAN/TO ST BALANCE knob**

Adjusts the panning or balance.

To adjust the value, press the knob to select it, and then operate the [TOUCH AND TURN] knob.

If the signal level reaches the overload point at any meter detection point in that channel, the Σ clipping indicator to the right of the knob will light.

④ **ST/MONO indicator**

If a channel is set to ST/MONO mode, these indicators will individually indicate the on/off status of signals sent from the channel to the STEREO bus/MONO bus.

If that channel is set to LCR mode, the LCR indicator will be displayed in this location. The LCR indicator indicates the on/off status of all signals sent from that channel to the STEREO bus/MONO bus.



## Sending signals from MIX channels and STEREO/MONO channels to MATRIX buses

You can send a signal from a MIX or STEREO/MONO channel to MATRIX buses 1–8 in the following two ways.

### Using the SELECTED CHANNEL section

With this method, you use the [TOUCH AND TURN] knob to adjust the send levels to the MATRIX buses. This method allows you to simultaneously control the signals sent from a specific MIX, STEREO (L/R), or MONO (C) channel to all MATRIX buses.

### ■ Using the faders (SENDS ON FADER mode)

With this method, you switch the QL series unit to SENDS ON FADER mode, and use the faders on the top panel to adjust the level of signals sent to the MATRIX buses. When using this method, signals sent from MIX and STEREO/MONO channels to a specific MIX/MATRIX bus can be adjusted simultaneously.

### Using the SELECTED CHANNEL section

Use the [TOUCH AND TURN] knob to adjust the send level of signals sent from the desired MIX, STEREO (L/R) or MONO (C) channel to all MATRIX buses.

#### STEP

1. Assign an output port to the MATRIX bus to which you want to send signals, and connect an external device.
2. Use the Bank Select keys in the Fader Bank section and the [SEL] keys on the top panel to select the channels that will send signals to the MATRIX buses.
3. In the SELECTED CHANNEL VIEW screen, turn on the TO MATRIX SEND ON/OFF button for the send-destination MATRIX bus.
4. Use the [TOUCH AND TURN] knob to adjust the send levels to the MATRIX buses.



SELECTED CHANNEL VIEW screen

#### NOTE

- You can also use the [SEL] key in the MASTER section to directly select the STEREO/MONO channels.

- If you want to monitor the signal being sent to a specific MATRIX bus, use the Bank Select keys in the Fader Bank section to access the corresponding MIX/MATRIX channel, and then press the appropriate [CUE] key in the Channel Strip section.

## MATRIX SEND screen



- 1 **ALL PRE button**  
Sets the send point to PRE. (The send point is the point at which signals are sent from all send-source channels — including the input and output channels — to the selected send destination.)
- 2 **ALL POST button**  
Sets the send point to POST. (The send point is the point at which signals are sent from all send-source channels — including the input and output channels — to the selected send destination.)
- 3 **Send destination indicator**  
Indicates the currently-selected send destination.
- 4 **Send destination select buttons**  
Select MIX/MATRIX buses as the send destination.
- 5 **Channel select button**  
Selects the send-source channel that you wish to control. The current channel icon, number, and color appear on the button, and the channel name appears below the button.
- 6 **PRE/POST button**  
Switches the send point of each send-source channel between PRE and POST. If the button is lit, the send point is set to PRE.

⑦ **SEND ON/OFF button**

Switches the send of each send-source channel on or off.

⑧ **SEND PAN/BALANCE knob**

Sets the panning or balance of signals sent to the stereo send destination. If the send destination is monaural or set to FIXED, this knob will not appear.

If the send source is monaural, this knob functions as a PAN knob.

If the send source is stereo, you can use PAN/BALANCE mode setting in the TO STEREO/MONO window to select whether PAN/BALANCE will function as a PAN or BALANCE knob. The knob for the mode selected here will appear.

⑨ **SEND LEVEL knob**

Indicates the level of signals sent to the selected send destination. You can use the [TOUCH AND TURN] knob to control the level.



## Using the faders (SENDS ON FADER mode)

You can use the faders on the top panel to adjust signals that are sent from the MIX and STEREO/MONO channels to a specific MATRIX bus.

### STEP

1. Assign an output port to the MATRIX bus to which you want to send signals, and connect your monitor system etc. to the corresponding output port.
2. In the Function Access Area, press the SENDS ON FADER button, or press the key that is currently lit in the SENDS ON FADER section.
3. Use the MIX/MATRIX select buttons to switch between MIX/MATRIX.
4. Use the MIX/MATRIX bus select buttons in the Function Access Area, or the key in the SENDS ON FADER section to select the send-destination MATRIX bus.
5. Use the faders on the top panel to adjust the send level from the MIX and STEREO/MONO channels to the selected MATRIX bus.



**NOTE**

- Press the SENDS ON FADER button to switch to SENDS ON FADER mode. The faders in the Channel Strip section and Master section will move to the send levels of the signals that are routed from each channel to the currently-selected MIX/MATRIX bus. The [ON] keys will also change to the SEND ON status.
- If you press the currently-selected MIX/MATRIX bus select button again, cue monitoring will be turned on for the corresponding MIX/MATRIX channel. This method is convenient if you want to monitor the signal that is being sent to the selected MIX/MATRIX bus.
- You can assign the SENDS ON FADER function to a USER DEFINED key. This lets you quickly switch to SENDS ON FADER mode for a specific MIX/MATRIX bus, and quickly switch back again.

## Correcting delay between channels (Output Delay)

This Output Delay function is useful when you want to correct the timing of output signals sent to speakers that are located at a distance from each other.

**STEP**

1. In the Function Access Area, press the SETUP button.
2. Press the OUTPUT PORT button in the SYSTEM SETUP field located in the center of the SETUP screen.
3. Specifies the delay time, and turns on the DELAY button.



SETUP screen



OUTPUT PORT screen

## OUTPUT PORT screen



- 1 **Slot number/Card type**  
If an output channel of slot 1-2 is selected for operations, this area indicates the slot number and the type of I/O card installed in that slot.
- 2 **DELAY SCALE button**  
Press this button to open the DELAY SCALE window, in which you can select the unit for the delay time.
- 3 **Output Port**  
This is the type and number of the output port to which the channel is assigned.
- 4 **Channel select button**  
Enables you to select the channel that you want to assign to the output port. The name of the currently-selected channel is displayed.
- 5 **Delay time knob**  
Sets the delay time of the output port. Press the knob to select it, and then operate the [TOUCH AND TURN] knob. The millisecond delay time value is indicated above the knob, and the delay time value in the units selected in the DELAY SCALE window is indicated below the knob.

**NOTE**

If you have selected ms (millisecond) as the scale, the delay time value will not appear above the knob.

- ⑥ **DELAY button**  
Switches the output port delay on or off.
- ⑦ **Ø (Phase) button**  
Switches the phase of the signal assigned to the output port between normal phase (black) and reverse phase (yellow).
- ⑧ **GAIN knob**  
Adjusts the output gain of the output port. To adjust this value, press the knob on screen to select it, and then operate the [TOUCH AND TURN] knob. Rotate the knob to set the value in 1.0 dB steps. Rotate the knob while pressing and holding it down to set the value in 0.1 dB steps. The current value appears immediately below the knob.
- ⑨ **Level meter**  
Indicates the level of the signal assigned to the output port.
- ⑩ **Tabs**  
Switch the output ports controlled in groups of up to eight ports. Tabs are categorized into three groups: DANTE, SLOT, and PATCH VIEW. To display tabs in the desired group, press the group name button located at the right or left end of the bottom row.

## Using the PORT TO PORT function

### STEP

1. In the Function Access Area, press the **SETUP** button.
2. Press the **OUTPUT PORT** button in the **SYSTEM SETUP** field located in the center of the **SETUP** screen.
3. Press the channel select button in the **OUTPUT PORT** screen.
4. In the **CH SELECT** screen, select the output port.

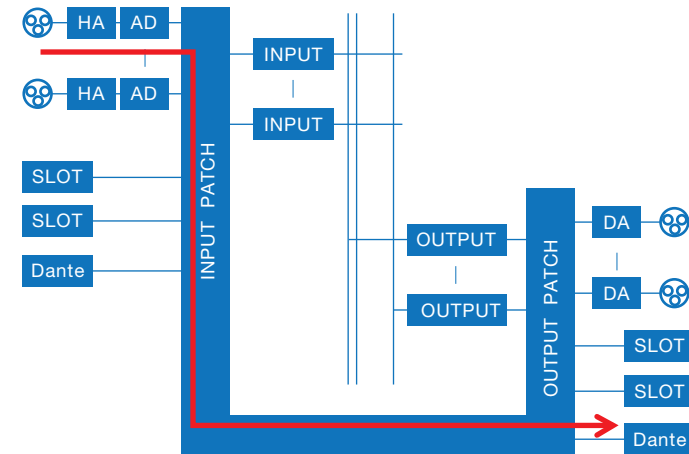

Use the PORT TO PORT function to output from an input jack on the rear panel to a Dante connector without sending the signal through the mixer. This allows you to use the I/O jacks on QL series consoles as I/O jacks for an audio network.

## CH SELECT screen

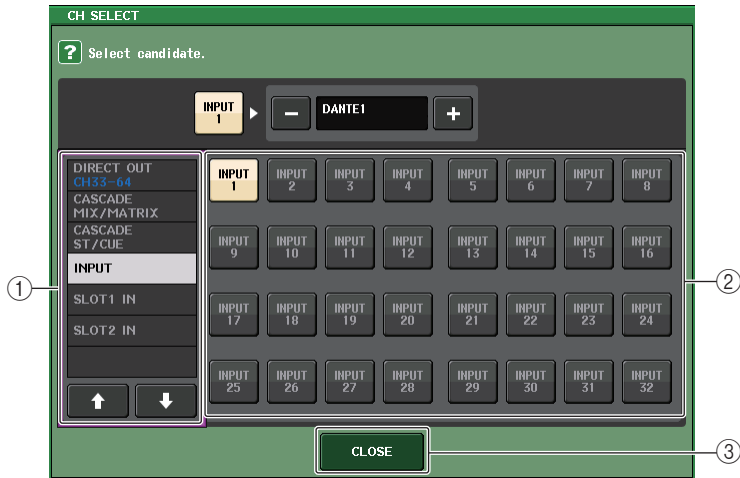

① **Category select list**

Select the category of the channel. The categories and channels for the PORT TO PORT function are shown below.

- **INPUT IN** ..... INPUT1-32\*1
- **SLOT1 IN** ..... SLOT1(1)-SLOT1(16)
- **SLOT2 IN** ..... SLOT2(1)-SLOT2(16)
- **PLAYBACK OUT** ..... PB OUT(L), PB OUT(R)

\*1. QL1: INPUT1-16

② **Channel select button**

Select the channel to be assigned to the output port from the current category.

③ **CLOSE button**

Closes the screen.

## Channel library operations

Channel libraries include “OUTPUT CHANNEL LIBRARY,” which enables you to store and recall various parameters (including the head amp settings) for output channels.

To recall the library, while an output channel is selected, press the LIBRARY button on the SELECTED CHANNEL VIEW screen.

For details on using the library, refer to the “Using the libraries” section in the separate Owner’s Manual.



# EQ and Dynamics

Each input channel and output channel on a QL series console provides a four-band EQ and dynamics.

EQ can be used on all input channels and all output channels. An attenuator is provided immediately before the EQ, allowing you to attenuate the level of the input signal so that the GAIN setting for EQ will not cause the signal to clip. Input channels also provide a high-pass filter that is independent of the EQ.

Input channels provide two dynamics processors: Dynamics 1 can be used as a gate, ducking device, compressor, or expander, while Dynamics 2 can be used as a compressor, hard compander, soft compander, or de-esser. Output channels provide one dynamics processor, which can be used as a compressor, expander, hard compander, or soft compander.

## Using EQ

This section explains the four-band EQ that is provided on input channels and output channels.

### STEP

1. Use the Bank Select keys and the [SEL] keys to select the channel that you want to control.
2. Press the EQ graph field in the SELECTED CHANNEL VIEW screen.
3. Press the 1ch tab in the HPF/EQ window.
4. Press the EQ ON button, and adjust the EQ parameters.

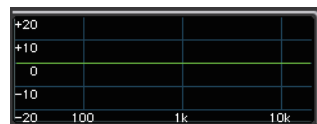

SELECTED CHANNEL VIEW screen



HPF/EQ window

### NOTE

- The EQ field in the OVERVIEW screen shows the response of the EQ. In this OVERVIEW screen, you can edit the parameter by using the EQ knobs in the SELECTED CHANNEL section.
- EQ settings can be saved and recalled at any time using the dedicated library. You can also take advantage of a wide variety of presets suitable for various instruments or situations.
- You can also access the SELECTED CHANNEL VIEW screen, and use the knobs in the SELECTED CHANNEL section to edit the EQ and high-pass filter (page 8).
- Even when the HPF/EQ window is displayed, you can use the knobs in the SELECTED CHANNEL section to control the EQ.

## HPF/EQ window (1ch)

This lets you edit all EQ parameters of the currently-selected channel. This is convenient if you want to make detailed EQ settings for a specific channel.

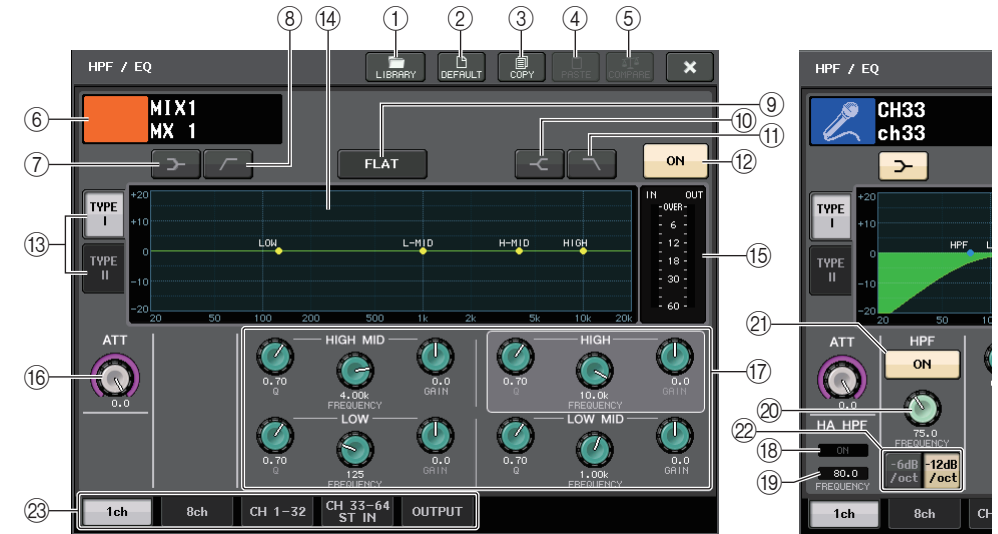

- 1 **LIBRARY button**  
Press this button to open the EQ Library window.
- 2 **DEFAULT button**  
Press this button to reset all EQ/filter parameters to the initial values.
- 3 **COPY button**  
All EQ parameter settings will be copied in buffer memory.
- 4 **PASTE button**  
Press this button to paste the setting in buffer memory to the current EQ. If no valid data has been copied in the buffer memory, nothing will happen.

**⑤ COMPARE button**

Press this button to swap between the current EQ settings and the data stored in buffer memory. If no valid data has been copied in the buffer memory, nothing will happen.

**NOTE**

For details on how to use buttons ①–⑤, refer to “Using the tool buttons” in the separate Owner’s Manual.

**⑥ Channel icon/Channel number/Channel name**

This area indicates the icon, number and name of the currently-selected channel.

**⑦ LOW SHELIVING ON/OFF button**

Turn on this button to select the shelving-type filter for the LOW band.

**⑧ HPF ON/OFF button (output channels only)**

Turn on this button to select the high pass filter for the LOW band.

**NOTE**

Output channels do not feature a high-pass filter that is independent of the EQ. However, you can turn on the high-pass filter button on the window to use the LOW band EQ as a high-pass filter.

**⑨ EQ FLAT button**

Press this button to reset the GAIN parameters of all EQ band to 0 dB.

**⑩ HIGH SHELIVING ON/OFF button**

Turn on this button to select the shelving-type filter for the HIGH band.

**⑪ LPF ON/OFF button**

Turn on this button to select the low pass filter for the HIGH band.

**⑫ EQ ON/OFF button**

Switches the EQ on or off.

**⑬ EQ type select button**

Switches between TYPE I (an algorithm used in previous Yamaha digital mixers) and TYPE II (an algorithm that reduces interference between bands).

**⑭ EQ graph**

Displays the parameter values for the EQ and filter.

**⑮ EQ IN/OUT level meters**

Indicates the peak level of signals before and after the EQ. For a stereo channel, these meters indicate the level of both the L and R channels.

**⑯ ATT knob**

Indicates the attenuation value before the signal enters the EQ. You can use the [TOUCH AND TURN] knob to adjust this.

**⑰ EQ parameter setting knobs**

Indicates the Q, FREQUENCY, and GAIN parameters for the LOW, LOW MID, HIGH MID, and HIGH bands. You can use the [TOUCH AND TURN] knob to adjust this.

**⑱ HA HPF ON indicator**

Indicates the HPF on/off status of the external head amp.

**⑲ FREQUENCY**

Indicates the HPF cutoff frequency of the external head amp.

**⑳ HPF FREQUENCY knob (input channels only)**

Indicates the cutoff frequency of the HPF. You can use the [TOUCH AND TURN] knob to adjust this.

**㉑ HPF ON/OFF button (input channels only)**

Switches the HPF on or off.

**㉒ HPF type select button (input channels only)**

Switches the HPF attenuation per octave between  $-12$  dB/oct and  $-6$  dB/oct.

**NOTE**

Input channels provide a high-pass filter that is independent of the four-band EQ. Turn on the HPF ON/OFF button, and use the HPF FREQUENCY knob to adjust the cutoff frequency.

**㉓ Tabs**

Use these tabs to select a channel that you want to view on the screen.

**NOTE**

- If shelving type has been selected for the LOW band, or if HPF is selected for the output channels, the LOW band Q parameter will not appear.
- If shelving type has been selected for the HIGH band, or if LPF is selected, the HIGH band Q parameter will not appear.



## HPF/EQ window (8ch)

This window displays the input channel or output channel EQ settings in groups of 8 channels simultaneously. Use the knobs in the SELECTED CHANNEL section to edit the EQ settings.



### ① Channel select button

Selects the channel that you want to control. The current channel icon and number appear on the button, and the channel name appears immediately below the button.

### ② EQ graph

Displays the parameter values for the EQ and filter. The currently-selected EQ type appears below the graph.

### ③ EQ ON/OFF button

Switches the EQ on or off. The OVER indicator (located to the right above the button) lights if the post-EQ signal is clipping.

### ④ HPF FREQUENCY knob (input channels only)

Indicates the cutoff frequency of the HPF. You can use the knobs in the SELECTED CHANNEL section to adjust this.

### ⑤ HPF ON/OFF button (input channels only)

Switches the HPF on or off.

## HPF/EQ window (CH1–32, CH33–64/ST IN (QL5), ST IN (QL1), OUTPUT)

This window displays the corresponding input channels (or output channels) simultaneously. This window is only for display, and does not allow the parameters to be edited. It is useful when you need to quickly check multiple EQ settings, or when you want to copy and paste EQ settings between distant channels.



### ① Channel select button

Selects the channel that you want to control in the SELECTED CHANNEL section. The current channel icon, number, and color appear on the button.

### ② EQ graph

This field graphically indicates the approximate response of the EQ and filters.

## Using dynamics

Input channels feature two dynamics processors; output channels feature one dynamics processor.

### STEP

1. Use the Bank Select keys and the [SEL] keys to select the channel for which you want to control the dynamics.
2. Press the THRESHOLD knob in the DYNAMICS1/DYNAMICS2 field in the SELECTED CHANNEL VIEW screen.
3. Press the 1 ch tab in the DYNAMICS1/2 window.
4. Press the DYNAMICS ON button, and adjust the dynamics parameters.

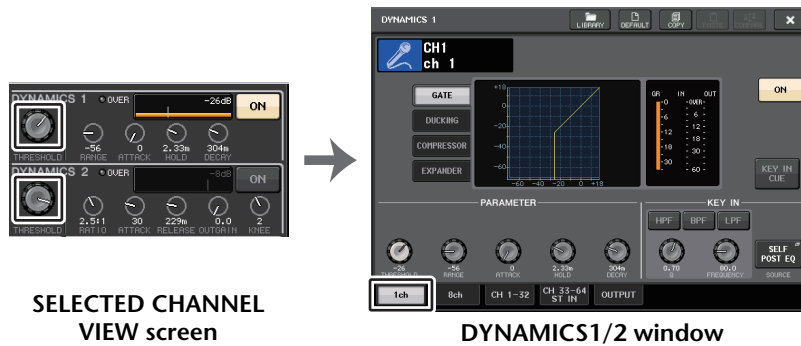

SELECTED CHANNEL VIEW screen

DYNAMICS1/2 window

### NOTE

- The DYNAMICS 1/2 field on the OVERVIEW screen displays the dynamics on/off status and the amount of gain reduction.
- Dynamics settings can be saved and recalled at any time using the dedicated library. You can also take advantage of a wide variety of presets suitable for various instruments or situations.
- You can also access the SELECTED CHANNEL VIEW screen, and use the knobs in the SELECTED CHANNEL section to edit the dynamics settings on [page 9](#).
- Even when the DYNAMICS 1/2 window is displayed, you can use the knobs in the SELECTED CHANNEL section to control the dynamics.

## DYNAMICS1/2 window (1ch)

All dynamics parameters can be viewed and edited by channel. This is convenient when you want to make detailed dynamics settings for a specific channel.

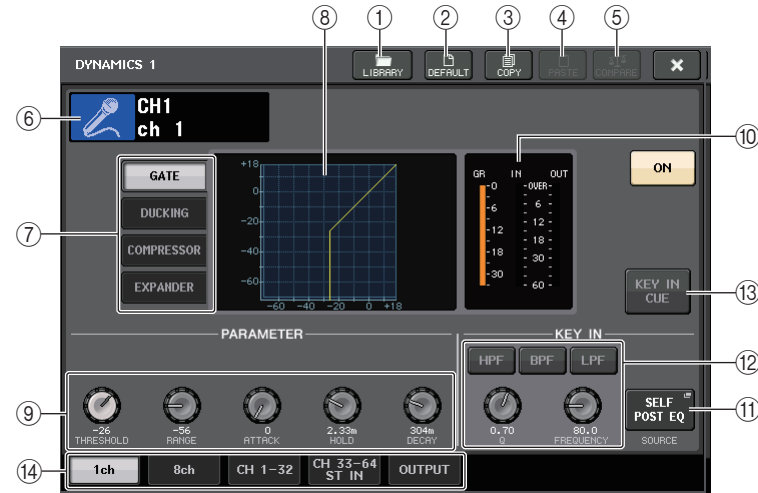

### ① LIBRARY button

Press this button to open the DYNAMICS Library window.

### ② DEFAULT button

Press this button to reset all dynamics parameters to the initial values.

### ③ COPY button

All dynamics parameter settings will be copied in buffer memory.

### ④ PASTE button

Press this button to apply the settings in buffer memory to the current dynamics. If no valid data has been copied in the buffer memory, nothing will happen.

### ⑤ COMPARE button

Press this button to swap between the current dynamics settings and the data stored in buffer memory. If no valid data has been copied in the buffer memory, nothing will happen.

### NOTE

For details on how to use buttons ①–⑤, refer to “Using the tool buttons” in the separate Owner’s Manual.

### ⑥ Channel icon/Channel number/Channel name

This area indicates the icon, number, and name of the currently-selected channel.

### ⑦ Dynamics type buttons

Enables you to select the dynamics type. You can choose from the following dynamics types.

- **Dynamics 1 for an input channel**  
GATE, DUCKING, COMPRESSOR, EXPANDER
- **Dynamics 2 for an input channel**  
COMPRESSOR, COMPANDER-H, COMPANDER-S, DE-ESSER
- **Dynamics 1 for an output channel**  
COMPRESSOR, EXPANDER, COMPANDER-H, COMPANDER-S

### ⑧ Dynamics graph

Displays the input/output response of the dynamics processors.

### ⑨ Dynamics parameter setting knobs

Indicates the dynamics parameter values. You can use the [TOUCH AND TURN] knob to adjust the values. The type of parameters will vary depending on the currently-selected dynamics type.

#### • GATE or DUCKING:



#### • COMPRESSOR or EXPANDER:

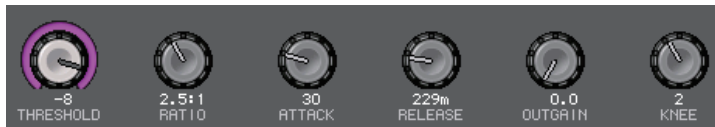

#### • COMPANDER-H or COMPANDER-S:

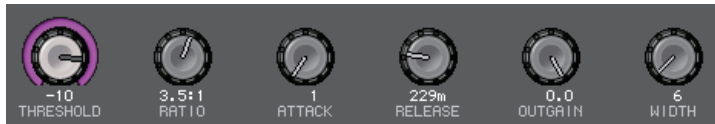

#### • DE-ESSER:



### ⑩ Dynamics IN/OUT level meters, GR meter

These meters indicate the peak level of the signals before and after the dynamics processing, and the amount of gain reduction. For a stereo channel, these meters indicate the level of both the L and R channels.

### ⑪ KEY IN SOURCE select button

Press this button to display the KEY IN SOURCE SELECT window, in which you can select a key-in signal that will trigger the dynamics.

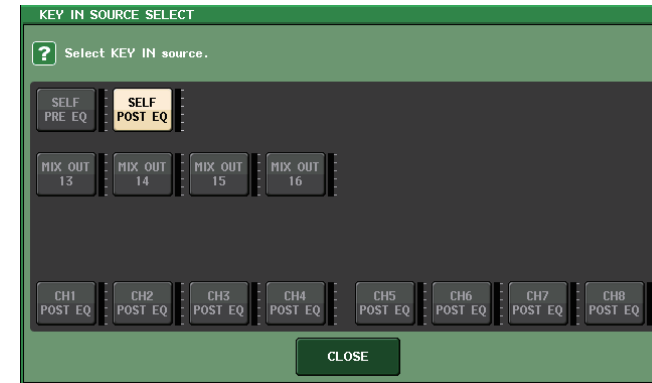

- **SELF PRE EQ** ..... The pre-EQ signal of the same channel.
- **SELF POST EQ** ..... The post-EQ signal of the same channel.
- **MIX OUT 13–16** ..... Output signals of MIX channels 13–16
- **CH1–64 POST EQ (QL5), CH1–32 POST EQ (QL1), ST IN1L–8R POST EQ, MIX1–16 POST EQ, MTRX1–8 POST EQ, ST L/R, MONO POST EQ** ..... The post-EQ signal of the corresponding channel\*<sup>1</sup>

\*1. The selectable signals are limited to the corresponding eight-channel group.

#### NOTE

In the case of QL1, channels that do not exist on the model will not be shown.

### ⑫ KEY IN FILTER parameter area (Displayed only for Gate or Ducking)

Enables you to make various settings for a filter that lets the key-in signal pass.

- **Filter select buttons** ..... Select the type of filter from HPF, BPF, or LPF. To disable the filter, press the button that is turned on.
- **Q knob** ..... Indicates the filter Q. You can use the [TOUCH AND TURN] knob to adjust the value.
- **FREQUENCY knob** ..... Indicates the filter cutoff frequency. You can use the [TOUCH AND TURN] knob to adjust the value.

### ⑬ KEY IN CUE button

Enables you to cue-monitor the signal that has been selected as the KEY IN SOURCE signal. Cue will be canceled if you have selected a dynamics type that does not feature this button, or if you move to a different screen.

### ⑭ Tabs

Use these tabs to select a channel that you want to view on the screen.

## DYNAMICS1/2 window (8ch)

This window displays the input channel or output channel dynamics settings in groups of 8 channels simultaneously. This window is convenient if you want to adjust the threshold or certain other parameters while watching the adjacent channels to the left and the right.



### ① Channel select button

Selects the channel that you want to control. The current channel icon and number appear on the button, and the channel name appears immediately below the button.

### ② DYNAMICS OUTPUT meters, GR meter

Indicate the output levels of signals after dynamics processing, and the amount of gain reduction. If GATE is selected as the dynamics type, a three-step indicator appears, indicating the open/close status of the gate.



Type = Any type other than GATE



Type = GATE

If GATE is selected as the dynamics type, the indicator status means the following:

Gate status				
On/Off status	Red	Yellow	Green	Off (dark)
Open/Close status	Close	Open	Open	—
Amount of gain reduction	30 dB or more	less than 30 dB	0 dB	—

### ③ Dynamics graph

Indicates the dynamics parameter values. The currently-selected dynamics type appears below the graph. Press the graph to access the DYNAMICS 1ch window for that channel.

### ④ THRESHOLD knob

Indicates the threshold value for the dynamics. You can use the [TOUCH AND TURN] knob to adjust the value.

### ⑤ DYNAMICS ON/OFF button

Switches dynamics on or off.

## DYNAMICS 1/2 window (CH1–32, CH33–64/ST IN (QL5), ST IN (QL1), OUTPUT)

This window enables you to make settings of the global dynamics parameters for the corresponding channel.



### ① Channel select button

Selects the channel that you want to control. The current channel icon, number, threshold, and color appear on the button.

## ② Dynamics parameter area

This area displays the dynamics type and various meters. Press the area to access the DYNAMICS 1ch window of that channel.

If DUCKING, EXPANDER, COMPANDER (-H/-S), or DE-ESSER has been selected as the dynamics type, the type appears near the top of this area.

The lower part of this area displays meters that indicate the levels of signals after dynamics processing, the GR meter, and the threshold (a numeric value). If the dynamics processor is any type other than GATE, the threshold setting is indicated as a vertical line.

## Using the EQ or Dynamics libraries

You can use dedicated libraries to store and recall EQ and dynamics settings. For details on using the EQ and dynamics libraries, refer to the “Using the libraries” section in the separate Owner’s Manual.

### EQ library

There is an “INPUT EQ LIBRARY” that lets you store/recall EQ settings for input channels, and an “OUTPUT EQ LIBRARY” that lets you store and recall EQ settings for output channels.

To recall settings from a library, press the LIBRARY tool button in the/HPF/EQ window.

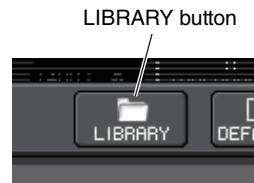

#### NOTE

You can recall 199 different settings from both the input EQ library and output EQ library. Forty (40) of the input library items are read-only presets, and three (3) of the output library items are read-only presets.

### Dynamics library

Use the “Dynamics Library” to store and recall dynamics settings. All of the dynamics processors on QL series units use this dynamics library. (However, the available types will differ between an input channel’s Dynamics 1 and Dynamics 2, and an output channel’s Dynamics 1. You cannot recall a type that cannot be selected.)

To recall an item from the dynamics library, press the LIBRARY tool button in the DYNAMICS 1/2 window.

#### NOTE

You can recall 199 different settings from the library. Forty-one (41) of these are read-only presets.

# Channel Job

This chapter explains the DCA Group and Mute Group functions that enable you to control the level or muting of multiple channels together, the Channel Link function that links the parameters of multiple channels, and the operations that enable you to copy or move parameters between channels.

## DCA group

QL series consoles feature sixteen DCA groups that enable you to control the level of multiple channels simultaneously.

DCA groups enable you to assign input channels to sixteen groups, so that the DCA faders can be used to control the level of all channels in each group. A single DCA fader will control the level of all input channels belonging to the same DCA group while maintaining the level difference between the channels. This provides a convenient way in which drum mics, for example, can be grouped.

## Assigning channels to a DCA group

There are two ways to assign a channel to a DCA group.

- You can select a specific DCA group and then specify the channels to be assigned to the group.
- You can select a specific channel and then specify the DCA group to which it should be assigned.

### NOTE

- DCA groups can be used only with input channels.
- DCA group settings are saved as part of the scene.

## ■ Selecting channels to belong to a specific DCA group

### STEP

1. In the Function Access Area, press the CH JOB button.
2. Press the DCA GROUP button.
3. Use the DCA GROUP select button to select the DCA group to which you want to assign channels.
4. Use the [SEL] keys of the input channels to select the input channels that you want to assign to the group (multiple selections are allowed).

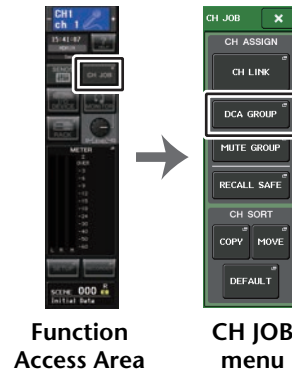

Function  
Access Area

CH JOB  
menu

### NOTE

- You can assign a single channel to more than one DCA group. In this case, the value will be the sum of the levels of all assigned DCA group faders.
- The DCA/MUTE GROUP field of the OVERVIEW screen indicates the DCA group(s) to which each channel is assigned. Numbers that are lit yellow in the upper and middle row of this field indicate the DCA groups to which that channel belongs.



## DCA/MUTE GROUP ASSIGN MODE window

Here you can specify the channels that will be assigned to each DCA group.

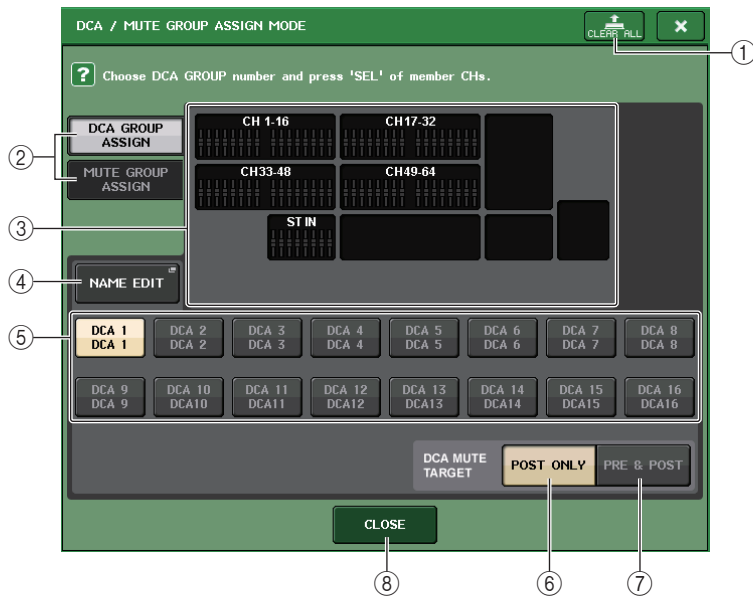

### ① CLEAR ALL button

Clears all channels that are assigned to the currently-selected DCA group.

### ② DCA GROUP ASSIGN/MUTE GROUP ASSIGN buttons

Toggle between the DCA GROUP ASSIGN window and MUTE GROUP ASSIGN window.

### ③ DCA group assign field

This area displays the channels assigned to the currently-selected DCA group. While this window is displayed, press the [SEL] key for the channel that you want to assign to the DCA group. The channel will be assigned to the DCA group, and the on-screen fader for that channel will turn yellow. Press the same [SEL] key once again if you want to remove the channel from the group.

### NOTE

In the case of the QL1, faders that do not exist on the model will not be shown.

### ④ NAME EDIT button

Edits the group name of the currently-selected DCA group. When you press this button the keyboard window will appear, allowing you to enter or edit the text.

### ⑤ DCA group select button

Selects the DCA group that you want to assign.

### ⑥ POST ONLY button

Specifies the object of muting in the DCA group as POST only.

### ⑦ PRE & POST button

Specifies the object of muting in the DCA group as PRE and POST. The PRE & POST indicator is shown below a DCA group that has this setting.

### ⑧ CLOSE button

Closes the window.

## ■ Selecting the DCA groups to which a specific channel will belong

### STEP

1. Press a [SEL] key to select the input channel you want to operate.
2. Use the DCA group select buttons in the SELECTED CHANNEL VIEW screen to select the DCA group(s) to which the currently-selected channel will be assigned (multiple selections are allowed).



SELECTED CHANNEL VIEW screen

DCA/MUTE field



## Controlling DCA groups

Use the DCA faders to control DCA groups.

### STEP

1. Assign input channels to DCA groups.
2. Using the faders in the Channel Strip section or Master section on the top panel, adjust the relative balance between the input channels that belong to the DCA group you want to use.
3. Use the Bank Select keys to select the [ST IN/DCA] key.
4. Use the Channel Strip section to operate the DCA group.

### Using DCA groups

Use the strip section to operate the DCA group.

- **Level adjustment: Faders** .... The level of the channels assigned to that DCA group can be adjusted while preserving the level differences of each channel. The input faders will not operate at this time.
- **On/Mute switch: [ON] key** ..... When you press an [ON] key in the strip section to make the key indicator go dark, the channels assigned to that DCA group will be muted (the same state as when the faders are lowered to the  $-\infty$  dB position).
- **Cue monitor: [CUE] key** ..... When you press the strip section [CUE] key to make it light, the [CUE] keys of the channels assigned to that DCA group will blink, and cue monitoring will be enabled. For more information about cue, refer to “Operating the Cue function” on page 92.

## Mute group

QL series consoles feature eight mute groups.

Mute groups enable you to use USER DEFINED keys [1]–[12] to mute or unmute multiple channels in a single operation. You can use this to cut out multiple channels simultaneously. Mute groups 1–8 can be used with both input channels and output channels. Both types of channels can exist in the same group.

### Assigning channels to mute groups

As with the DCA group, there are the following two ways to assign channels to mute groups.

- You can select a specific mute group first and then specify the channels to be assigned to the group.
- You can select a specific channel and then specify the mute group to which it should be assigned.

### Selecting the channels that will belong to a specific mute group

#### STEP

1. In the Function Access Area, press the CH JOB button.
2. Press the MUTE GROUP button in the CH JOB menu.
3. Use the mute group master buttons in the DCA/MUTE GROUP ASSIGN MODE window to select the mute group to which you want to assign channels.
4. Press the [SEL] key for the input channels/output channels that you want to operate (multiple selections are allowed).

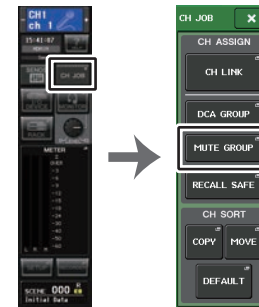

Function Access Area

CH JOB menu

#### NOTE

- You may assign a single channel to more than one mute group.
- The DCA/MUTE GROUP field of the OVERVIEW screen indicates the mute group(s) to which each channel is assigned. Numbers that are lit red in the lower line of this field indicate the mute groups to which that channel belongs.



- If the dimmer level is set to any level other than  $-\infty$  dB, and the corresponding MUTE GROUP MASTER button is turned on, these numbers will light orange. For a channel for which the Mute Safe function (page 60) has been turned on, an “S” indicator will light up green at the right end of the bottom row.

## DCA/MUTE GROUP ASSIGN MODE window

Here you can select the channels that will be assigned to each mute group.

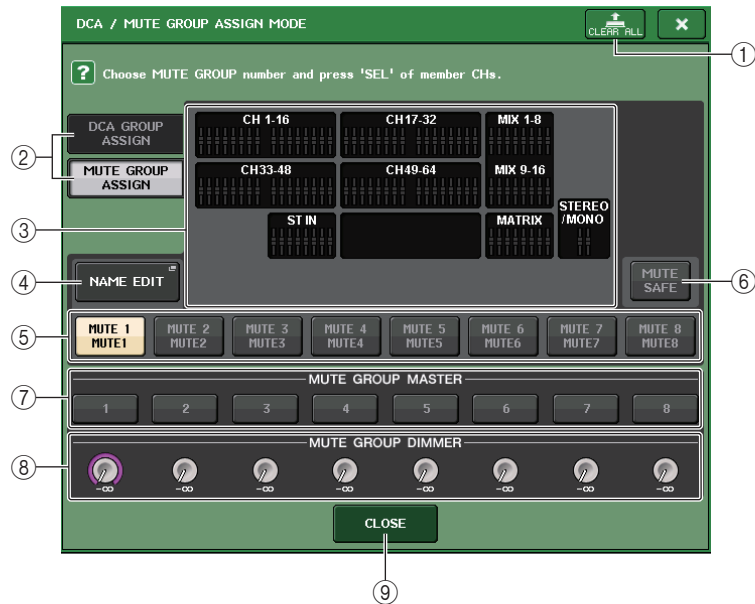

- ① **CLEAR ALL button**  
Clears all channels that are assigned to the currently-selected mute group.
- ② **DCA GROUP ASSIGN/MUTE GROUP ASSIGN buttons**  
Toggle between the DCA GROUP ASSIGN window and MUTE GROUP ASSIGN window.
- ③ **Mute group assign field**  
This area displays the channels assigned to the currently-selected mute group. While this window is displayed, press the [SEL] key for the channel that you want to assign to the mute group. The channel will be assigned to the mute group, and the on-screen fader for that channel will turn red. Press the same [SEL] key once again if you want to remove the channel from the group.  
If the MUTE SAFE button is on, this field displays the channels that enabled for mute safe (that is, excluded from the mute groups). The operation procedure to apply or cancel mute safe to the channels is the same as that for assigning or removing channels to or from a mute group. The on-screen faders of the assigned channels will turn green.
- ④ **NAME EDIT button**  
Edits the group name of the currently-selected mute group. When you press this button the keyboard window will appear, allowing you to enter or edit the text.

- ⑤ **Mute group select button**  
Selects the mute group that you want to assign.
  - ⑥ **MUTE SAFE button**  
Use this button if you want to exclude a specific channel from all mute groups, regardless of its assignment settings. The mute group assign field displays the channels that are excluded from the mute groups. For more information on mute safe, refer to "Using the Mute Safe function" on page 60.
  - ⑦ **MUTE GROUP MASTER button**  
Switches the mute for the corresponding mute group on or off.
  - ⑧ **DIMMER LEVEL knob**  
Sets the dimmer level for the corresponding mute group when the dimmer function is enabled.
- NOTE**
- In the case of the QL1, faders that do not exist on the model will not be shown.
  - If the dimmer level is set to any level other than  $-\infty$  dB, and the corresponding MUTE GROUP MASTER button is turned on, this button will light orange.
- ⑨ **CLOSE button**  
Closes the window.

### Selecting the mute groups to which a specific channel will belong

#### STEP

1. Press the [SEL] key of the input channels / output channels that you want to operate.
2. Use the mute group select buttons in the SELECTED CHANNEL VIEW screen to select the mute group(s) to which the currently-selected channel will be assigned. (Multiple selections are allowed.)



SELECTED CHANNEL VIEW screen

DCA/MUTE field

## Using mute groups

To control mute groups, you can use the MUTE GROUP MASTER buttons in the MUTE GROUP ASSIGN window. In addition, it may prove convenient if you assign the Mute On/Off function for a mute group 1–8 to a USER DEFINED key.

### Assigning mute groups to USER DEFINED keys

#### STEP

1. In the Function Access Area, press the SETUP button.
2. Press the USER SETUP button in the upper left of the SETUP screen.
3. Press the USER DEFINED KEYS tab in the USER SETUP window.
4. Press the button for the USER DEFINED key to which you want to assign the Mute On/Off function.
5. Choose "MUTE MASTER" in the FUNCTION column, and choose "MUTE GROUP x" (where "x" is the mute group number) in the PARAMETER 1 column.
6. When you press the OK button, the Mute On/Off function will be assigned to the USER DEFINED key that you selected in step 4.



SETUP screen

USER SETUP window

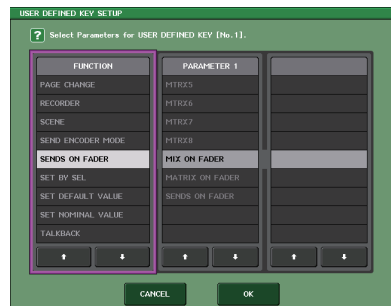

USER DEFINED KEY SETUP window

#### NOTE

The USER SETUP window enables you to limit available functionality by user, and also to make system-wide settings. This window includes several pages, which you can switch between using the tabs located at the bottom of the window.

### Turning mute groups on/off with USER DEFINED keys

To mute a mute group, press the USER DEFINED key to which you have assigned the Mute On/Off function.

The LED of the USER DEFINED key will light, and all channels that belong to the selected mute group will be muted. At this time, the [ON] keys of the muted channels will blink. You can turn on multiple USER DEFINED keys to mute multiple mute groups.

To defeat muting for a mute group, press the USER DEFINED key that you lit.

#### NOTE

Even if a channel is assigned to a mute group, it will not be affected by operations of the USER DEFINED key if the [ON] key for that channel is already turned off to begin with.

## Using the Mute Safe function

Specific channels that belong to a mute group can be temporarily excluded from mute group operations (Mute Safe). Channels that are set to Mute Safe will not be affected when you mute a mute group to which that channel belongs.

#### STEP

1. In the Function Access Area, press the CH JOB button.
2. Press the MUTE GROUP button in the CH JOB menu.
3. Press the MUTE SAFE button in the DCA/MUTE GROUP ASSIGN MODE window.
4. Press a [SEL] key for the channel(s) you want to exclude from mute groups (multiple selections are allowed).

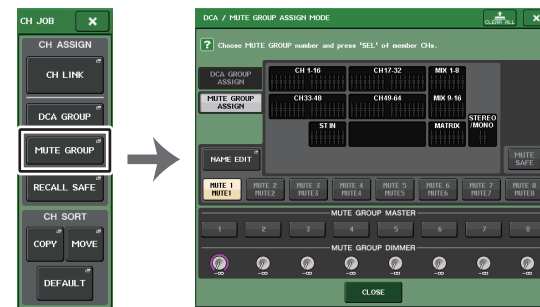

CH JOB menu

DCA/MUTE GROUP ASSIGN MODE window

**NOTE**

The [SEL] key of the channel set for Mute Safe will light, and the on-screen fader for that channel will be highlighted in green. You can cancel the Mute Safe status by pressing a lit [SEL] key once again to make it go dark.

**Temporarily disabling the Mute function**

Mute can be temporarily disabled by turning on the [ON] key; and resumed by turning it off, when you mute one of the mute groups to which that channel belongs. However, this mute control by turning on/off the [ON] key is disabled in the PREVIEW mode.

**Using the Recall Safe function**

“Recall Safe” is a function that excludes only specific parameters/channels (DCA groups) from Recall operations. Unlike the Focus Recall function (page 80), which you can apply to individual scenes, the Recall Safe settings are globally applied to all scenes.

**STEP**

1. In the Function Access Area, press the CH JOB button.
2. Press the RECALL SAFE button in the CH JOB menu.
3. Press the [SEL] key for the channel or DCA group that will be affected by Recall Safe operations.
4. Select the target for Recall Safe operations in the SAFE PARAMETER SELECT field in the RECALL SAFE MODE window.
5. To enable Recall Safe for the selected channel, turn on the SAFE button on. (If you selected a DCA group, turn on either the LEVEL/ON button or the ALL button.)
6. To enable Recall Safe for global parameters, turn on the buttons of the GLOBAL RECALL SAFE field.
7. When you have finished making settings, press the CLOSE button to close the window. Then perform a Recall operation.

**NOTE**

- Simply selecting a parameter in step 4 does not enable Recall Safe. To turn Recall Safe on or off, you must also perform the operation described in step 5.
- Bus settings are not subject to Recall Safe. They will always be reproduced in the recalled scene. This means that if Recall Safe is enabled for one of several channels included in a link group or one of two channels set to stereo, the parameter settings of that channel may differ from those of the other channel(s). In such cases, the applicable parameter will be automatically re-linked the next time it is operated.  
You can globally apply Recall Safe to channel links by using the global parameter.
- You can use the Recall Safe function along with the Focus Recall function (page 80). Channels or parameters that are excluded from Recall operations by either Focus or Recall Safe will not be recalled.
- If you hold down the [SEL] key while performing a recall operation, all parameters of that channel will be treated as Recall Safe regardless of the state of the SAFE PARAMETER SELECT selections.

**RECALL SAFE MODE window**

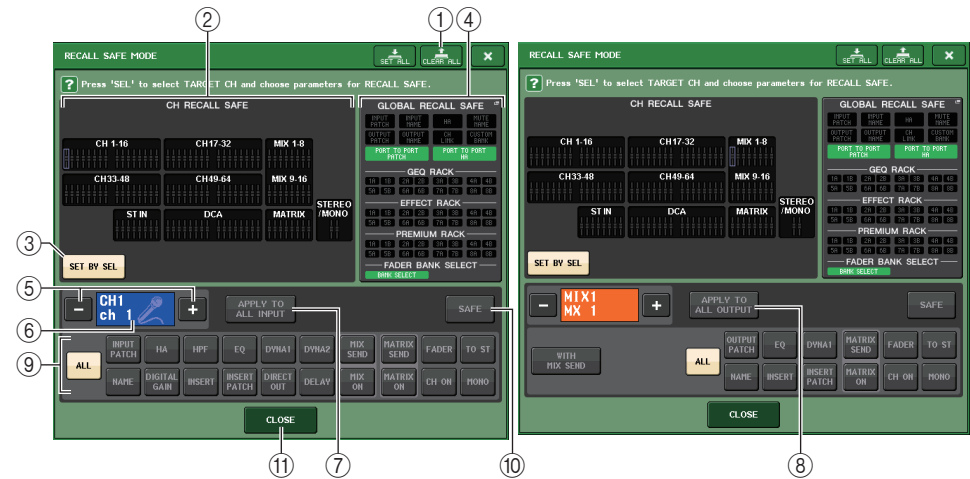

① **CLEAR ALL button/SET ALL button**

The CLEAR ALL button turns off (disables) the Recall Safe function (that is currently set for individual channels) and the Global Recall Safe function simultaneously. The SET ALL button turns on (enables) these functions simultaneously.

**NOTE**

The parameters that would be affected by the Recall Safe function will not change.



Function Access Area

CH JOB menu

② **CH RECALL SAFE field**

Indicates the channels currently specified to Recall Safe function.



**All parameters are affected by Recall Safe on these channels.**



**Some parameters are affected by Recall Safe on these channels.**



**Recall Safe has been canceled on these channels.**

③ **SET BY SEL button**

Enables you to use the [SEL] keys on the panel to select channels that will be affected by the Recall Safe function. Turn this button on, and then press the [SEL] key for the channel to which you want to apply Recall Safe. Recall Safe will turn on. Press the same [SEL] key once again to de-select the channel.

④ **GLOBAL RECALL SAFE display field**

Indicates the state of Recall Safe settings that are not made in units of channels, and the Recall Safe settings for racks. Press this field to open the GLOBAL RECALL SAFE window. These buttons correspond to the following parameters.

INPUT PATCH	All input channel patching (including INSERT IN/OUT and DIRECT OUT patching)
INPUT NAME	All input channel names, icons, and channel colors
OUTPUT PATCH	All output channel patching (including INSERT IN/OUT patching)
OUTPUT NAME	All output channel names, icons, and channel colors
HA	All I/O devices, and HA-related parameters for external head amps
CH LINK	All channel link group settings
MUTE GROUP NAME	Name of the mute group
CUSTOM FADER BANK	Custom fader bank settings
GEQ RACK EFFECT RACK PREMIUM RACK	Apply Recall Safe to GEQ racks 1–16, Effect racks 1–8, Premium racks 1–8 individually.
FADER BANK SELECT	FADER BANK selections, GAIN/PAN/ASSIGN knob selection status (set in units of blocks)
PORT TO PORT HA	PORT TO PORT settings
PORT TO PORT PATCH	PORT TO PORT patching

**NOTE**

If a dual-type GEQ rack or Premium rack has been selected, you can apply Recall Safe to rack A and B individually. For other racks, the setting for racks A and B will be linked.

⑤ **Channel select button**

Selects the channel for which you want to set the Recall Safe function.

**NOTE**

Switching channels using this button will not affect the channel selection on the top panel.

⑥ **Selected channel display**

This area indicates the icon, number, color, and name of the currently-selected channel.

⑦ **APPLY TO ALL INPUT button (input channels only)**

Turn on this button to apply the Recall Safe parameter selection for one input channel to all other input channels.

Turn this on if you want to apply Recall Safe to the same parameters for all input channels.

⑧ **APPLY TO ALL OUTPUT button (shown only for output channels)**

Turn on this button to apply Recall Safe parameter selection for one output channel to all other output channels.

Turn this on if you want to apply Recall Safe to the same parameters for all output channels.

⑨ **SAFE PARAMETER SELECT field (excluding DCA groups)**

Selects Recall Safe parameters for the selected channel.

The button indication varies depending on the channel type.

• **Input channel**



**NOTE**

ST IN channels do not feature INSERT, INSERT PATCH, and DIRECT OUT button.

• **MIX channel**



• **MATRIX channel**



• **STEREO channel**



• MONO channel



If Recall Safe is turned on for global parameters, the safe parameter select buttons of the selected channel will light green, as follows.



In this illustration, the items that are lit green indicate that the INPUT PATCH, INSERT PATCH, and DIRECT OUT parameters have been set to Safe by the INPUT PATCH Global parameter settings.

In the same way, turning on the Global parameters INPUT NAME, OUTPUT PATCH, and OUTPUT NAME will cause the corresponding safe parameters of each channel to light green. On-screen buttons and corresponding parameters apply to the following channels:

Button name	Corresponding parameter	Input channel	MIX channel	MATRIX channel	STEREO/MONO channel
WITH MIX SEND	Send level to the MIX bus		○		
WITH MATRIX SEND	Send level to MATRIX bus			○	
ALL*1	All parameters	○	○	○	○
HA	HA-related settings	○			
HPF	HPF settings	○			
EQ	EQ settings	○	○	○	○
DYNA 1	Dynamics 1 settings	○	○	○	○
DYNA 2	Dynamics 2 settings	○			
MIX SEND	Send level to MIX bus	○			
MATRIX SEND	Send level to MATRIX bus	○	○		○
FADER	Fader settings	○	○	○	○
CH ON	[ON] key settings	○	○	○	○
TO ST	On/off setting for STEREO bus assignment, PAN, etc.	○	○		
MONO	On/off setting for MONO bus assignment	○	○		
INPUT PATCH	Input patch settings	○			
DIGITAL GAIN	Digital gain settings	○			
INSERT*2	Insert on/off	○*3	○	○	○
INSERT PATCH*2	Insert patch settings	○*3	○	○	○

Button name	Corresponding parameter	Input channel	MIX channel	MATRIX channel	STEREO/MONO channel
DIRECT OUT	Direct Out settings	○*3			
MIX ON	MIX Send On/Off	○			
MATRIX ON	MATRIX Send On/Off	○	○		○
DELAY	Delay settings	○			
NAME	Channel name	○	○	○	○
OUTPUT PATCH	Output patch settings		○	○	○
BAL	BLANCE parameter settings			○	○ (STEREO only)

\*1. The default setting is ALL on.  
 \*2. Insert 1 and Insert 2 are set together.  
 \*3. ST IN channels do not feature these buttons.

⑨ **SAFE PARAMETER SELECT field (DCA)**

Enables you to select parameters for a DCA group that will be affected by Recall Safe operations. If the ALL button is on, all DCA master parameters will be subject to Recall Safe. If LEVEL/ON is on, the DCA master level and on/off status will be subject to Recall Safe. Unlike when a channel is selected, Recall Safe will be enabled for that DCA group the moment you turn on either the LEVEL/ON button or the ALL button.



⑩ **SAFE button (excluding DCA groups)**

When this button is turned on, Recall Safe will be enabled for the selected channel.

**NOTE**

Even if a parameter is selected with the Safe Parameter Select button, Recall Safe will not be enabled if this button is off.

⑪ **CLOSE button**

Closes the window.



## Channel Link function

Channel Link is a function that links the operation of parameters such as fader and EQ between input channels. Two or more input channels that are linked are called a “link group.” There is no limit on the number of link groups you can create, or on the number and combinations of input channels that can be included in these link groups. You can select the types of parameters to be linked for each link group.

The parameters to be linked can be selected from the following choices.

- Head amp settings
- Digital gain settings
- HPF settings
- EQ settings
- Dynamics 1 settings
- Dynamics 2 settings
- Insert on and insert point settings
- Direct Out on, Direct Out level, and Direct Out point settings
- Send levels and PRE/POST settings of signals sent to MIX buses
- On/off status of signals sent to MIX buses
- Send levels and PRE/POST settings of signals sent to MATRIX buses
- On/off status of signals sent to MATRIX buses
- Fader operations
- [ON] key operations
- TO STEREO/MONO setting
- DELAY setting
- DCA GROUP ASSIGN setting
- MUTE GROUP ASSIGN and MUTE SAFE settings

## Linking the desired input channels

This section explains how to link specific parameters of input channels.

### NOTE

Channel link settings are saved as part of the scene.

### STEP

1. In the Function Access Area, press the CH JOB button.
2. Press the CH LINK button in the CH JOB menu.
3. To link channels, hold down the [SEL] key for the link-source input channel and press the [SEL] key for the link-destination channel.
4. Use the buttons of the LINK PARAMETER field in the CH LINK MODE window to select the parameter(s) that will be linked (multiple selections are allowed).
5. If you turned on the MIX ON, MIX SEND, MATRIX ON, or MATRIX SEND buttons in step 4, use the buttons of the SEND PARAMETER field to specify the bus(es) for which you want operations to be linked (multiple selections are allowed).

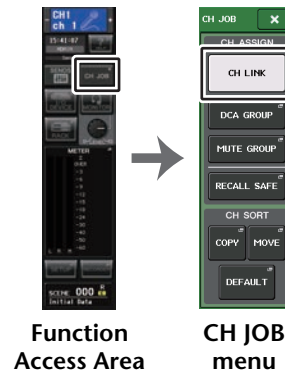

### NOTE

- You can also access the CH LINK MODE window by simultaneously pressing and then releasing the [SEL] keys of two or more channels that will be linked.
- When you press the [SEL] key for a channel (that belongs to a link group) to make it light, the [SEL] keys of all channels that belong to the same link group will blink.
- If you link an input channel to a ST IN channel, parameters that do not exist for a ST IN channel will be ignored.



## CH LINK MODE window

You can view the channels that are linked and specify the parameters that will be linked.

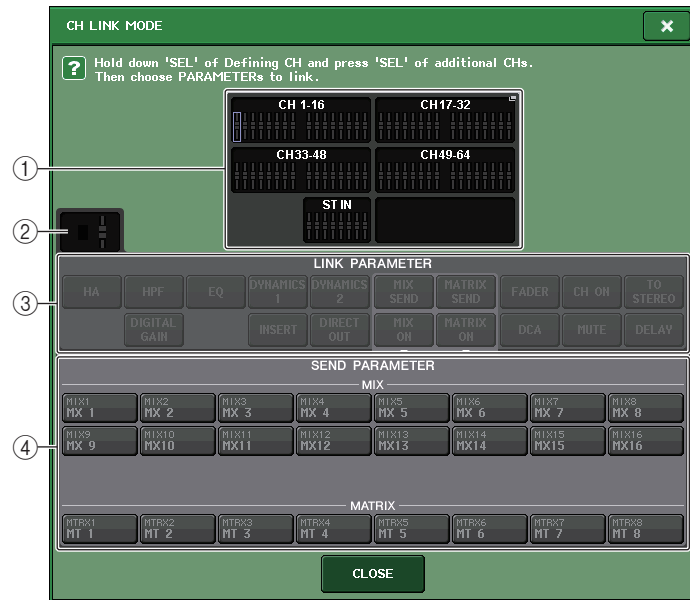

### ① Channel display field

When you create a link group, the corresponding channels will be highlighted. If there are two or more link groups, each group is shown in a different color. Press this field to open the CH LINK SET window. You can also link channels in this window.

#### NOTE

- Left and right of the ST IN channel are always linked.
- In the case of the QL1, faders that do not exist on the model will not be shown.

### ② Link indicator

If a channel belonging to a link group is selected, the associated link group is shown. The LINK PARAMETER field and SEND PARAMETER field show the link settings. While you hold down the [SEL] key of a channel that does not belong to any link group, the link indicator shows the link group that will be created next. The LINK PARAMETER field and SEND PARAMETER field show the settings of the link group that had been previously displayed.

### ③ LINK PARAMETER field

Use the buttons in this field to select the parameters that you want to link. You can do this independently for each link group.

The table below lists the parameters you can select in the LINK PARAMETER field.

HA	Head amp settings
HPF	HPF settings
DIGITAL GAIN	Digital gain settings
EQ	EQ settings
DYNAMICS 1, 2	Dynamics 1 and 2 settings
INSERT	Insert settings
DIRECT OUT	Direct Out settings
MIX SEND	Send levels of signals sent to MIX buses
MIX ON	On/off status of signals sent to MIX buses
MATRIX SEND	Send levels of signals sent to MATRIX buses
MATRIX ON	On/off status of signals sent to MATRIX buses
FADER	Fader operations
DCA	DCA group assignment
CH ON	Channel on/off
MUTE	Mute group assignment
TO STEREO	On/off status of signals sent to STEREO/MONO buses
DELAY	Channel delay settings

#### NOTE

- If you link Dynamics 1 or 2 for two or more input channels, the parameter values will be linked, but the key-in sources are not linked and can instead be set for each channel. The behavior of key-in signals is linked in units of 8ch\*. For details about dynamics, see “EQ and Dynamics” on page 49.
  - \* Units of 8ch means Ch1–8, Ch9–16, Ch17–24, Ch25–32, Ch33–40, Ch41–48, Ch49–56, Ch57–64, ST IN 1L–ST IN 4R, and ST IN 5L–ST IN 8R.
- If you turn on the EQ button or DYNAMICS 1/2 buttons, library recall operations will also be linked.
- The HA analog gain setting and the fader operation will be linked and will maintain the same relative level difference between the channels.
- In the insert settings, the parameters for Insert 1 and Insert 2 are selected together.

④ **SEND PARAMETER field**

If you have turned on the MIX ON, MIX SEND, MATRIX ON, or MATRIX send buttons in the LINK PARAMETER field, use the buttons in this field to specify the send-destination bus(es).

MIX1-16	MIX buses 1-16
MTRX 1-8	MATRIX buses 1-8

**NOTE**

If nothing is selected in the SEND PARAMETER field, send on/off and send level will not be linked.

■ **Channel link operations**

• **Linking three or more channels**

Hold down the link-source [SEL] key and successively press the [SEL] key of each channel you want to add to the link group.

• **Adding a new channel to an existing link group**

Hold down any [SEL] key within the group and press the [SEL] key that you want to add to the group.

**NOTE**

If the link-destination channel is already assigned to another link group, its assignment to the previous group will be canceled, and it will be added to the newly assigned group.

• **Removing a channel from a link group**

Hold down any [SEL] key in the same link group, and press the [SEL] key for the channel that you want to remove.

• **Changing the level balance between channels that belong to the same link group**

While pressing and holding down the [SEL] key for the desired linked channel, adjust the parameter value. You can also remove all linked channels from the same link group temporarily. This can be helpful if you want to edit parameters that are linked to each other while maintaining the same relative level differences. For example, this may be the case for parameters such as the HA analog gain and fader. While you are holding down the [SEL] key, the HA analog gain and fader values will not be linked. (However, you cannot temporarily cancel this link during the “fading” phase of a recalled scene.)

**CH LINK SET window**

Displayed when you press the channel display field in the CH LINK MODE window. You can also link channels in this window.

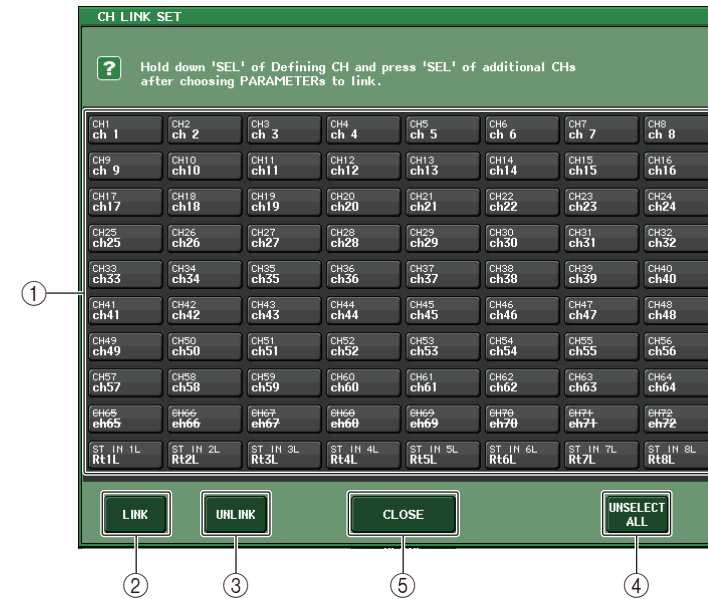

① **Channel select button**

Select a channel that you want to link. The selected channel will be indicated in blue, and the alphabetical character that indicates the link group will appear for linked channels.

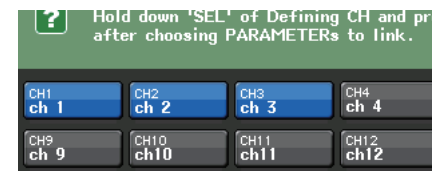

When selecting a channel

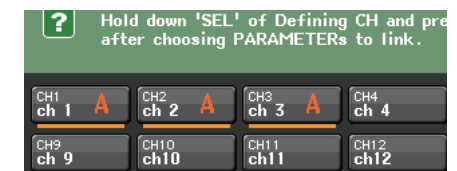

When linking channels

② **LINK buttons**

Link the channel selected in ①.

③ **UNLINK button**

Cancels the link selected in ①.

④ **UNSELECT ALL**

De-selects all selected channels currently appearing in blue.

### ⑤ CLOSE button

Closes the window.

#### NOTE

If you use QL5 settings data on the QL1, buttons will be shown crossed-out if they are assigned to a channel that does not exist on that model.

## Copying, moving, or initializing a channel

You can copy or move mix parameters between channels, or restore the parameters of a specific channel to their default settings.

### Copying the parameters of a channel

You can copy the mix parameter settings of a channel to another channel. When you execute the copy operation, the settings will overwrite the parameters of the copy-destination.

You can copy between the following combinations of channels.

- Between input channels
- Between the STEREO L/R channel and MONO channel
- Between MIX channels
- Between MATRIX channels

#### STEP

1. In the Function Access Area, press the CH JOB button.
2. Press the COPY button in the CH JOB menu.
3. Press a [SEL] key to select the copy-source channel.
4. Press the [SEL] key for the copy-destination channel (multiple selections are allowed).
5. If you have selected a MIX/MATRIX channel as the copy-source, use the buttons in the COPY TARGET field to select the parameters you want to copy.
6. Press the COPY button to execute the copy.

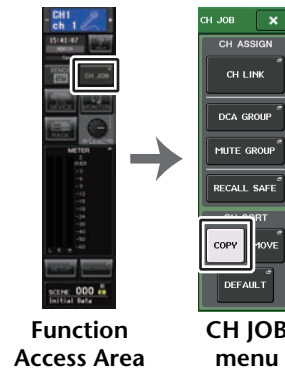

## CH COPY MODE window

This window enables you to copy channel settings.

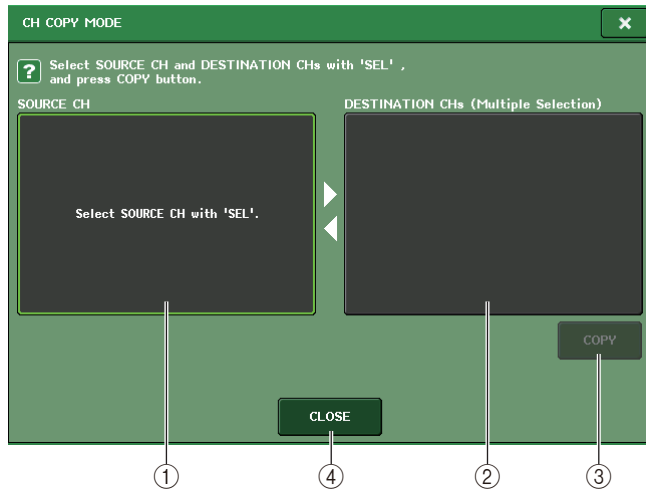

### ① SOURCE CH field

Displays the copy-source channel. While this window is displayed, press a [SEL] key on the top panel to select a channel. The selected channel will be highlighted in this field. If you want to re-select the copy-source channel, press this field.

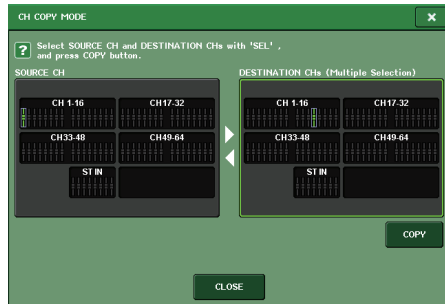

If the copy source is a MIX/MATRIX channel, buttons will appear so you will be able to select parameters to copy.

### COPY TARGET field

- **MODULE PARAMETERS button**  
Selected channel module parameters
- **WITH MIX SEND/WITH MATRIX SEND button**  
SEND parameters of signals sent to the selected channel

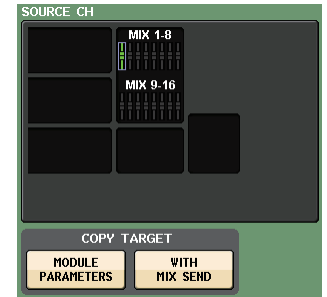

### ② DESTINATION CHs field

Displays the copy-destination channel. When you specify the copy source, you can then select a copy-destination channel (multiple selections are allowed) by pressing its [SEL] key on the panel, and this field will be highlighted. If you want to defeat all of the selected copy-destination channels, press the DESTINATION CHs field.

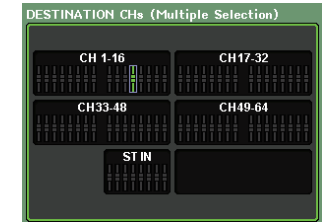

### NOTE

In the case of the QL1, faders that do not exist on the model will not be shown.

### ③ COPY button

Executes the copy operation. After selecting the copy-source channel and copy-destination channel(s), press this button to execute the copy operation.

### ④ CLOSE button

Press this button to close the window and return to the previous screen.

## Moving the parameters of a channel

The settings of a specific input channel can be moved to a different input channel. When you execute a Move operation, the numbering of the channels between the move-source and move-destination will move forward or backward by one.

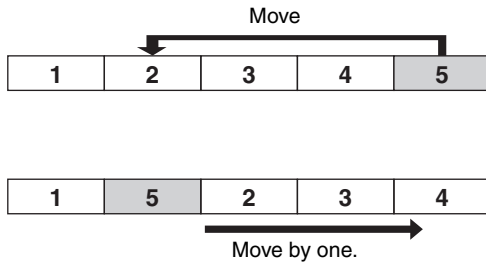

You can move settings between the following combinations of channels.

- Between input channels
- Between ST IN channels

### STEP

1. In the Function Access Area, press the CH JOB button.
2. Press the MOVE button in the CH JOB menu.
3. Press a [SEL] key to select the move-source channel.
4. Press the [SEL] key for the move-destination channel.
5. To execute the move, press the MOVE button.

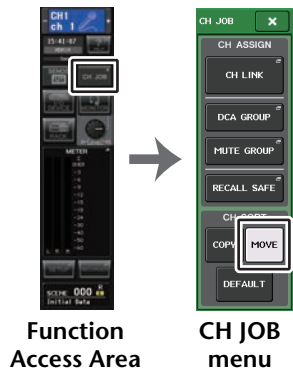

Function Access Area

CH JOB menu

## CH MOVE MODE window

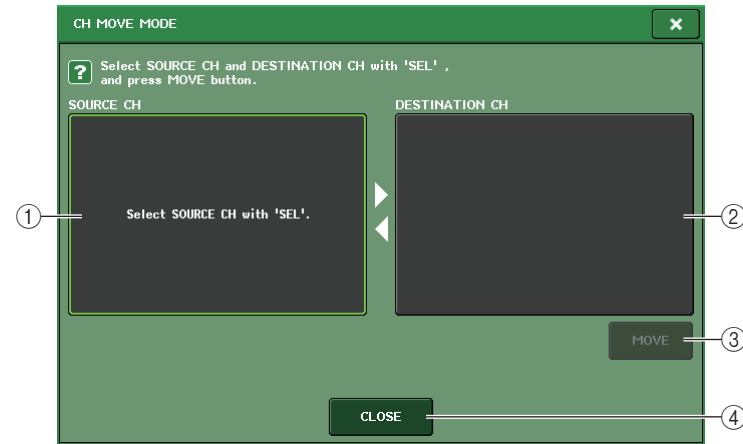

### ① SOURCE CH field

Displays the move-source channel. While this window is displayed, press a [SEL] key on the top panel to select an input channel. The selected channel will be highlighted in this field. If you want to re-select the move-source channel, press this field.

### ② DESTINATION CH field

Displays the move-destination channel. When you specify the move-source, you can then select the move-destination input channel by pressing its [SEL] key on the panel. When the move-destination channel is selected, this field will be highlighted. If you want to defeat the selected move-destination channel, press the DESTINATION CH field.

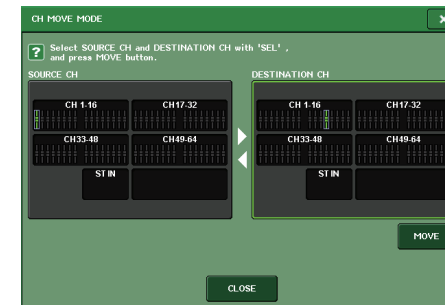

### NOTE

In the case of the QL1, faders that do not exist on the model will not be shown.

### ③ MOVE button

Executes a move operation. After selecting the move-source channel and move-destination channel, the channel settings move from the move-source to the move-destination. The settings of all channels between the move-source and move-destination will shift toward the move-source by one channel.

④ **CLOSE button**

Press this button to close the window and return to the previous screen.

### Initializing the parameters of a channel

You can restore the parameters of a channel to an initialized state. This operation can be performed on any channel(s).

**STEP**

1. In the Function Access Area, press the CH JOB button.
2. Press the DEFAULT button in the CH JOB menu.
3. Press the [SEL] key of the channel(s) to be initialized to make it light (multiple selections are allowed).
4. Press the DEFAULT button to execute the Initialization.

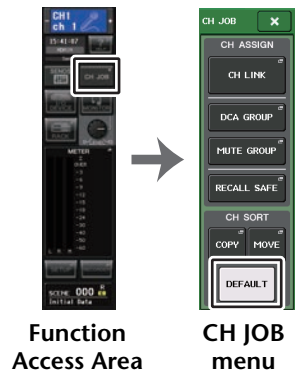

**NOTE**

After initialization, the TARGET CHs field will be empty (nothing is selected).

### CH DEFAULT MODE window

Enables you to initialize parameters.

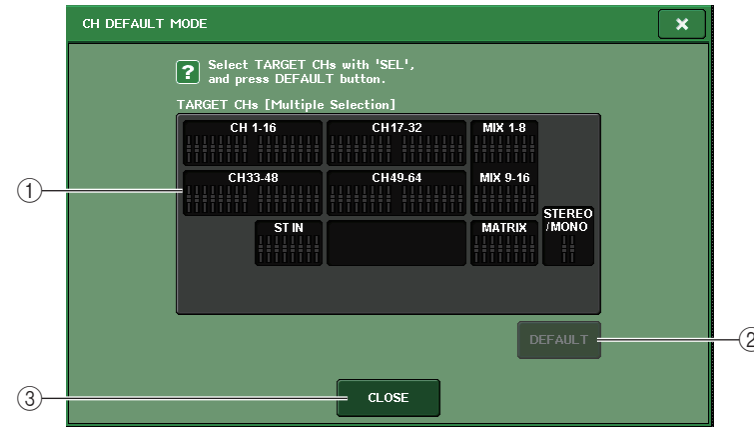

① **TARGET CHs field**

Indicates the channel selected for initialization. While this window is displayed, press a [SEL] key on the top panel to select an input channel (multiple selection is allowed). The field will indicate the selected channel(s). Press the same [SEL] key once again to de-select the channel.

**NOTE**

- If you press this field while a channel is selected, all selected channels will be de-selected.
- In the case of the QL1, faders that do not exist on the model will not be shown.

② **DEFAULT button**

After selecting the channel, press this button to execute the initialization operation.

③ **CLOSE button**

Press this button to close the window and return to the previous screen.

## Scene memory

On QL series consoles, you can assign a name to a set of mix parameter and input/output port patch settings, and store the mix settings in memory (and later recall them from memory) as a “scene.”

Each scene is assigned a number in the range of 000–300. Scene 000 is a read-only scene used to initialize the mix parameters. Scenes 001–300 are writable scenes.

Each scene contains the position of the top panel faders and [ON] key status, as well as the following parameters.

- Input/output port patching
- Channel name and color
- Bus settings
- Head amp settings
- Digital gain settings
- EQ settings
- Dynamics 1 and 2 settings
- Input delay settings
- Rack (GEQ/Effect/Premium Rack) settings
- Pan/balance settings
- Insert/Direct Out settings
- On/off status and send level of signals sent to MIX buses
- On/off status and send level of signals sent to MATRIX buses
- Settings for signals sent to the STEREO/MONO bus
- DCA group settings
- Mute group settings
- Channel link settings
- Panel assignment status (PANEL SNAPSHOT)
- CUSTOM FADER BANK settings

The number of the currently-selected scene appears in the SCENE field of the Function Access Area.

## SCENE field

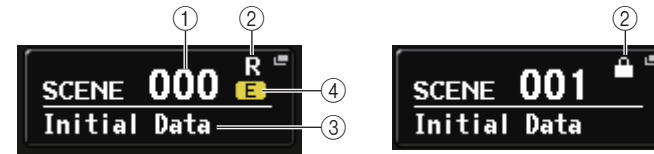

You can press the SCENE field to access the SCENE LIST window, in which you can view and edit additional settings for the scene.

- ① **Scene number**  
Indicates the number of the currently-selected scene. When you select a new scene number, the number will blink. This blinking indicates that the displayed scene number is different than the currently-loaded scene number.
- ② **R symbol (READ ONLY)/Protect symbol**  
Read-only scenes are indicated by an R symbol (READ ONLY) displayed here. Write-protected scenes are indicated by a Protect symbol.
- ③ **Scene title**  
Indicates the title of the currently-selected scene.
- ④ **E symbol (EDIT symbol)**  
This symbol appears when you edit the mix parameters for the currently-loaded scene. This symbol indicates that you must execute the Store operation if you want to keep the changes you made.

### NOTE

You cannot store data to a scene number for which the Protect symbol or R symbol is displayed.



## Storing and recalling scenes

To store or recall the current mix settings as a scene memory, use the SCENE LIST window.

### Storing a scene

#### ■ Using the SCENE LIST window

##### STEP

1. Use the controllers on the top panel or the buttons on the touch screen to set the mix parameters as desired.
2. Press the SCENE field in the Function Access Area.
3. Turn the [TOUCH AND TURN] knob to select the store-destination scene number.
4. Press the STORE button in the SCENE LIST window.
5. Assign a title or comment to the scene as desired.
6. Press the STORE button located in the lower part of the SCENE STORE window.
7. Press the OK button in the STORE CONFIRMATION dialog box to execute the Store operation.

##### NOTE

- You can select multiple scene numbers as the store-destination. To do so, press the MULTI SELECT button to turn it on, and then rotate the [TOUCH AND TURN] knob. Alternatively, rotate the [TOUCH AND TURN] knob while pressing and holding it down.
- If you selected multiple scenes as the store-destination, the same contents will be stored in all selected scene numbers. This is convenient if you want to create several variations based on the same mix settings.

### SCENE STORE window



#### ① SCENE TITLE field

Press this field to select it, and then enter a title for the scene (maximum 16 characters).

#### ② COMMENT field

Press this field to select it, and then enter a comment for the scene. You can use this as a memorandum for each scene (maximum 32 characters).

##### NOTE

For details on entering text, refer to "Assigning a name" in the separate Owner's Manual.

## SCENE LIST window

Here you can perform various scene-related operations. This window will appear when you press the SCENE field.

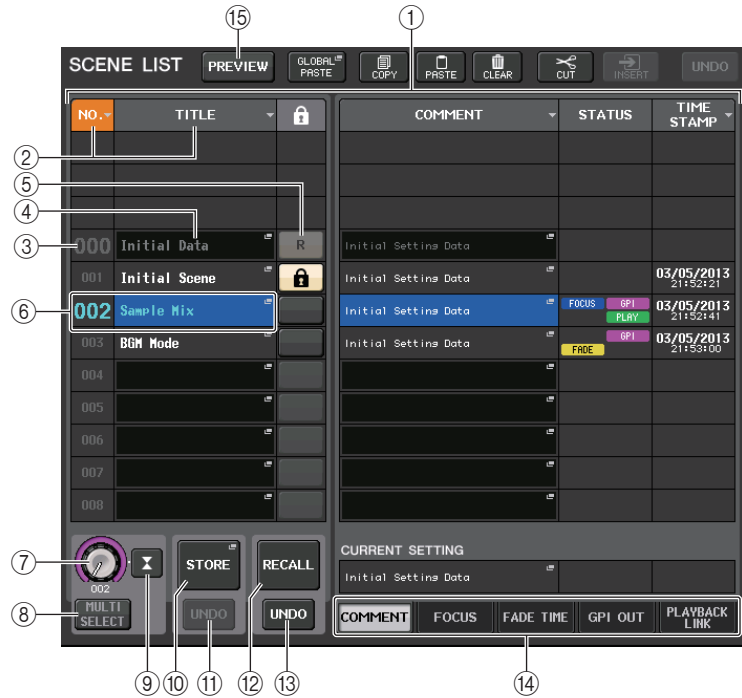

### ① Scene list

This area lists various data about the scenes stored in memory.

### ② NO./TITLE buttons

Press these buttons to sort the listed scenes by number or title. Press the same button repeatedly to toggle between ascending order and descending order.

### ③ Scene number

Indicates the scene number.

### ④ Scene title

Indicates the scene title. Press this button to display the SCENE TITLE EDIT window, in which you can edit the title.

### ⑤ Write-protect

Indicates the Write Protect on/off status. Press this button to write-protect the scene. A lock icon will appear. Press it again to cancel write protection.

### ⑥ Current scene

The currently-selected scene (that is, the current scene) is highlighted in blue in the list. If you press another scene number in the list, the list will scroll and that scene will become the current scene.

### ⑦ SCENE SELECT knob

Use the [TOUCH AND TURN] knob to select a scene. You can view the currently-selected scene number immediately below the SCENE SELECT knob. You can select consecutive multiple scenes by rotating the [TOUCH AND TURN] knob while pressing and holding it down.

### ⑧ MULTI SELECT button

You can select consecutive multiple scenes by turning on this button and rotating the [TOUCH AND TURN] knob.

### ⑨ LAST SCENE button

Selects the scene that was recalled most recently.

### ⑩ SCENE STORE button

This button stores the current mix settings. Press this button to display the SCENE STORE window, which will enable you to assign a name to a scene and store it.

### ⑪ STORE UNDO button

Undoes the Store operation. This button is valid only immediately after you perform an Overwrite-store operation.

### NOTE

- The STORE UNDO button is available only immediately after overwrite-storing.
- You can also assign the function of the STORE UNDO button to a USER DEFINED key ([page 169](#)).

### ⑫ RECALL SCENE button

Recalls the currently-selected scene.

### ⑬ RECALL UNDO button

Undoes the Recall operation. This button is valid only immediately after you perform a Recall operation.

### ⑭ Page switching tabs

Switch the views for the right side of the SCENE LIST window.

### ⑮ PREVIEW button

Press this to select PREVIEW mode, which allows you to view and edit the scene settings in the display and the panel without affecting the signal processing of the current scene.

## Recalling a scene

### STEP

1. Press the SCENE field in the Function Access Area.
2. Rotate the [TOUCH AND TURN] knob to select the scene number to recall.
3. Press the RECALL button in the SCENE LIST window.

### SCENE LIST window



#### ① RECALL SCENE button

Recalls the currently-selected scene.

#### ② RECALL UNDO button

Undoes the Recall operation. This button is valid only immediately after you perform a Recall operation.

#### NOTE

- You can also assign the function of the RECALL UNDO button to a USER DEFINED key ([page 169](#)).
- You can also use MIDI messages (Program Changes) to recall scenes ([page 141](#)).

## Using USER DEFINED keys to recall

You can use the USER DEFINED keys to recall a selected scene with a single keystroke, or to step through the scenes. To do this, you must first assign a scene recall operation to a USER DEFINED key. The following recall operations can be assigned to a USER DEFINED key.

- **RECALL**  
Immediately recalls the currently-loaded scene.
- **INC RECALL**  
Immediately recalls the scene of the number that follows the currently-loaded scene.
- **DEC RECALL**  
Immediately recalls the scene of the number that precedes the currently-loaded scene.

#### NOTE

If no scene is stored in the number that precedes or follows the currently-loaded scene, the closest scene number in which a scene is stored will be recalled.

- **DIRECT RECALL**

Directly recalls the scene number that you assigned to the USER DEFINED key. When you press a USER DEFINED key to which this function is assigned, the assigned scene will be recalled immediately.

### STEP

1. In the Function Access Area, press the SETUP button.
2. Press the USER SETUP button in the upper left of the SETUP screen.
3. Press the USER DEFINED KEYS tab in the USER SETUP window.
4. Press the button for the USER DEFINED key to which you want to assign a function.
5. In the FUNCTION column, select "SCENE."
6. Selects the function you want to assign.
  - To assign INC RECALL or DEC RECALL  
Choose "INC RECALL" or "DEC RECALL" in the PARAMETER 1 column.
  - To assign DIRECT RECALL  
Choose "DIRECT RECALL" in the PARAMETER 1 column, and choose "SCENE #xxx" (xxx is the scene number) in the PARAMETER 2 column.
7. When you have finished making settings, press the OK button to close the window.
8. Press the USER DEFINED key to which you want to assign a recall function.



SETUP screen

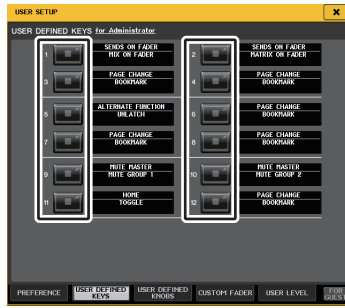

USER SETUP window

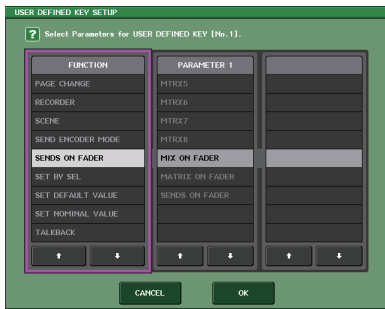

USER DEFINED KEY SETUP window

## Editing scene memories

This section explains how to sort the scenes stored in scene memory, edit their titles, and copy and paste them.

### Sorting scene memories

#### STEP

1. Press the SCENE field in the Function Access Area.
2. Press the COMMENT tab at the bottom of the SCENE LIST window.
3. Rotate the [TOUCH AND TURN] knob on the top panel to select a scene.
4. Edit the scene.

### SCENE LIST window

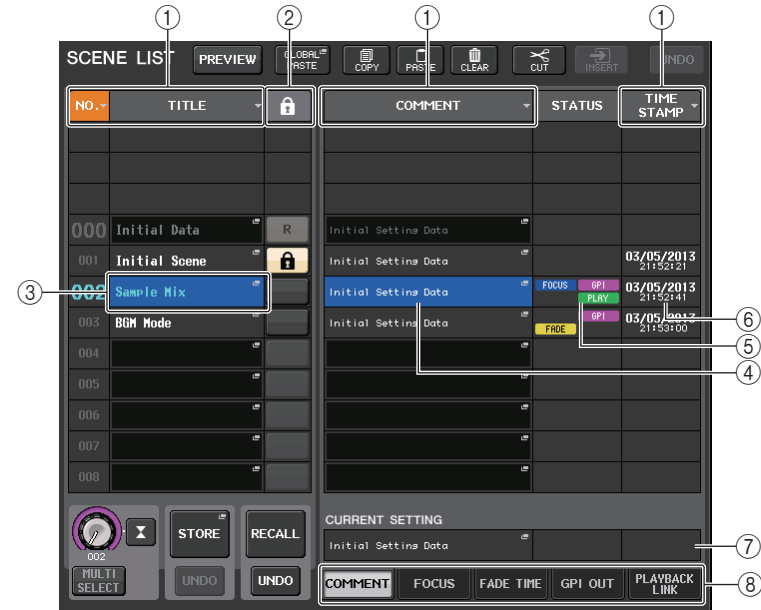

① **Sort button**

The list will be sorted as follows, according to the column heading you press.

- **NO.**  
Sorts the list in order of scene number.
- **TITLE**  
Sorts the list in numerical/alphabetical order of title.
- **COMMENT**  
Sorts the list in numerical/alphabetical order of comments.
- **TIME STAMP**  
Sorts the list in order of date of creation.

**NOTE**

By pressing the same location again, you can change the sorting order (ascending or descending).

② **Write-protect**

Indicates the Write Protect on/off status. Press this button to write-protect the scene. A lock icon will appear. Press it again to cancel write protection.

③ **TITLE field**

Press this field to open the SCENE TITLE EDIT window, in which you can enter the title for the scene. You can edit titles in this window.

④ **COMMENT field**

Press this field to open the SCENE COMMENT EDIT window, in which you can enter comments for the scene. You can edit comments in this window.

⑤ **STATUS field**

Indicators in this field indicate the setting status of the FOCUS, FADE TIME, PLAYBACK (playback link), and GPI (General Purpose Interface) functions. (The Playback Link function plays a desired song in a specified time duration after a scene is recalled.)

⑥ **TIME STAMP field**

Indicates the date and time the scene was stored.

For details on the TIME STAMP display format, refer to “[Setting the date and time of the internal clock](#)” on [page 191](#).

⑦ **CURRENT SETTING field**

Specifies the content that will be saved by the next scene store operation. Changes made here are immediately reflected on the QL series console.

⑧ **Tabs**

Enable you to switch between items. You can use tabs to switch the view of the right half of the window between five different fields (COMMENT/FOCUS/FADE TIME/GPI OUT/PLAYBACK LINK).

**Scene memory editing**

The scenes stored in scene memory can be copied and pasted to other scene numbers, or cleared (erased). You can edit scene memories using the buttons located in the upper part of the SCENE LIST window.

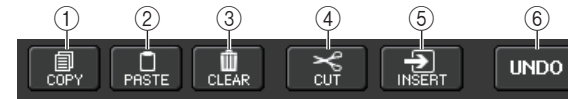
① **COPY button**

Press this button to copy the scene to buffer memory.

② **PASTE button**

Press this button to overwrite the selected scene with the scene in buffer memory.

③ **CLEAR button**

Press this button to erase the selected scene.

④ **CUT button**

Press this button to delete the selected scene and copy it to buffer memory. The numbers of the subsequent scenes will be decremented by one.

⑤ **INSERT button**

Press this button to insert the scene copied to buffer memory into the selected scene number. The numbers of the subsequent scenes will be incremented by one.

⑥ **UNDO button**

Cancels the most recent scene memory paste, clear, cut, or insert operation and restores the previous state.

## Copying and pasting a scene

You can copy a scene into buffer memory, and then paste it to a different scene number.

### NOTE

The Global Paste function enables you to copy any channel or any parameter settings for the current scene, then paste the data into any single or multiple scenes in memory (page 78).

### STEP

1. Press the SCENE field in the Function Access Area.
2. Rotate the [TOUCH AND TURN] knob to select the copy-source scene number, and then press the COPY button in the SCENE LIST window.
3. Press the OK button in the CONFIRMATION dialog box to execute the copy.
4. Rotate the [TOUCH AND TURN] knob to select the paste-destination scene number, and then press the PASTE button.
5. Press the OK button in the CONFIRMATION dialog box to execute the paste operation.

### NOTE

- Be aware that if you copy or cut another scene before you paste, the newly copied or cut scene will overwrite the scene in the buffer memory.
- You cannot select multiple scenes as the copy-source.
- You can select multiple paste-destination scenes. To do so, press the MULTI SELECT button to turn it on, and then rotate the [TOUCH AND TURN] knob. In this case, the same content will be pasted to all selected scenes.
- A copied scene can also be inserted (page 77).
- If nothing has been copied to the buffer memory, the PASTE button will be unavailable.

## Clearing a scene

### STEP

1. Press the SCENE field in the Function Access Area.
2. Rotate the [TOUCH AND TURN] knob to select the scene number to clear, and then press the CLEAR button in the SCENE LIST window.
3. Press the OK button in the CONFIRMATION dialog box to execute the Clear operation.

### NOTE

- You may select multiple scenes to be cleared. To do so, press the MULTI SELECT button to turn it on, and then rotate the [TOUCH AND TURN] knob.
- Read-only scenes or write-protected scenes cannot be cleared.

## Cutting a scene

This section explains how to cut a scene.

When you cut a scene, the numbers of the subsequent scenes will be decremented accordingly. You can paste or insert a cut scene at the desired location. To cut a scene, sort the scene list in order of scene number.

### STEP

1. Press the SCENE field in the SCENE LIST window of the Function Access Area.
2. Rotate the [TOUCH AND TURN] knob to select the scene number to cut, and then press the CUT button in the SCENE LIST window.
3. Press the OK button in the CONFIRMATION dialog box to execute the Cut operation.
4. If desired, you can paste (page 77) or insert the cut scene (that was copied to the buffer memory).

### NOTE

- Read-only scenes or write-protected scenes cannot be cut.
- Be aware that if you copy or cut another scene before you paste or insert, the newly copied or cut scene will overwrite the scene in the buffer memory.

## Inserting a scene

You can insert a scene copied to buffer memory at a desired scene number location. To insert a scene, sort the scene list in order of scene number.

### STEP

1. Press the SCENE field in the Function Access Area.
2. Copy (page 77) or cut the scene you want to insert.
3. Rotate the [TOUCH AND TURN] knob to select the insert-source scene number, and then press the INSERT button in the SCENE LIST window.
4. Press the OK button in the CONFIRMATION dialog box to execute the Insert operation.

### NOTE

- If you select multiple scenes as the insert-destination, the same scene will be inserted the selected number of times.
- If nothing has been copied to the buffer memory, the INSERT button is not available.
- The INSERT button will be unavailable if there is already a scene stored at scene number 300, or if the Insert operation would cause an already-stored scene to exceed number 300.
- When you insert a scene, scenes that were stored in subsequent numbers following that location will be updated and increase by the number of scenes that were inserted.

## Using the Global Paste function

“Global Paste” is a function that lets you copy and paste settings for the desired channel or parameter from the current scene to scene data in memory (multiple selections are allowed). This can be convenient if you want to apply changes (that you made to the current scene) to multiple scenes that have already been stored.

### NOTE

The Global Paste function will be available for a user if the SCENE LIST STORE/SORT parameter is turned on in his or her user level settings.

### STEP

1. Press the SCENE field in the Function Access Area.
2. Press the GLOBAL PASTE button in the SCENE LIST window.
3. Use the tabs in the GLOBAL PASTE window to select the item you want to copy.
4. Press the [SEL] key on the top panel to select the copy-source channel, and then press the button in the window to select a parameter.
5. Use the [TOUCH AND TURN] knob to select the range of paste-destination scenes.
6. Press the PASTE button to execute the paste operation.



SCENE LIST window

GLOBAL PASTE window

### NOTE

- A progress bar will be displayed as the data is being pasted.
- During the paste operation, the STOP button will appear. Press the STOP button if you want to abort the operation. In that case, part of the data will be pasted and you will be unable to undo the operation.
- You cannot select different parameters from different channels.

## GLOBAL PASTE window



### ① SET BY SEL button

Turn on this button to add a channel by using the corresponding [SEL] key.

### ② CLEAR ALL button/SET ALL button

The CLEAR ALL button clears all of the selected channels. The SET ALL button selects all channels simultaneously.

### NOTE

In the case of the QL1, faders that do not exist on the model will not be shown.

### ③ Tabs

Enable you to switch between items.

#### • INPUT tab

Select an input channel in the upper left area, and select its parameter in the lower left area.

You can select the following parameters.

ALL	All input channel parameters
INPUT PATCH	Input patch settings
NAME	Channel name, icon, and channel color
HA	Settings for the head amp assigned to the corresponding input channel, and phase
DELAY	Input delay settings
HPF	HPF settings
DIGITAL GAIN	Digital gain settings for the corresponding input channel



EQ	EQ settings
DYNA1	Dynamics 1 settings (including KEY IN SOURCE and KEY IN FILTER)
DYNA2	Dynamics 2 settings (including KEY IN SOURCE)
MIX SEND	Send level, pan, and PRE/POST of the signal sent to a MIX bus
MATRIX SEND	Send level, pan, and PRE/POST of the signal sent to a MATRIX bus
FADER	Fader level
CH ON	On/off status of [ON] keys
INSERT*1	Insert on/off status and insert point
INSERT PATCH*1	Insert in/out patch settings, head amp settings for insert-in
DIRECT OUT	Direct Out on/off, Direct Out level, Direct Out point and patch settings
MIX ON	Send on/off to a MIX bus
MATRIX ON	Send on/off to a MATRIX bus
TO ST	TO ST on/off, pan/balance settings
MONO	TO MONO on/off

\*1. The parameters for Insert 1 and Insert 2 are selected together.

• **OUTPUT tab**

Select an output channel in the upper left area, and select its parameter in the lower left area.

You can select the following parameters.

ALL	All output channel parameters
OUTPUT PATCH	Output patch settings
NAME	Channel name, icon, and channel color
EQ	EQ settings
DYNA 1	Dynamics 1 settings (including KEY IN SOURCE)
INSERT*1	Insert on/off status and insert point
INSERT PATCH*1	Insert in/out patch settings, head amp settings for insert-in
FADER	Fader level
CH ON	On/off status of [ON] keys
TO ST/BAL	TO ST on/off, pan/balance settings
MONO	TO MONO on/off status (MIX 1–16 only)
MATRIX SEND	Send level, pan, and PRE/POST of the signal sent to a MATRIX bus
MATRIX ON	Send on/off to a MATRIX bus
WITH SEND FROM SOURCE CHs	SEND parameters of the send-source signal that will be sent to a channel CHs

\*1. The parameters for Insert 1 and Insert 2 are selected together.

• **RACK tab**

Enables you to choose from GEQ RACK, EFFECT RACK, or PREMIUM RACK. You can individually select an GEQ for a Flex15GEQ or an effect used in dual mode.

• **PATCH/OTHERs tab**

You can select the following parameters.

INPUT PATCH	All input channel patches, insert in/out patches, Direct Out patches
OUTPUT PATCH	All output channel patches, insert in/out patches
INPUT NAME	Channel names, icons, and colors for all input channels
OUTPUT NAME	Channel names, icons, and colors for all output channels
HA	Analog gain, phantom power on/off status, Gain Compensation, phase settings
CH LINK	Channel link settings
CUSTOM FADER BANK	Custom fader bank settings

• **DCA tab**

You can select either ALL or LEVEL/ON. If ALL is selected, all channel parameters will be copied. If LEVEL/ON is selected, the master level and DCA channel on/off status will be copied. You can select the copy-source items for each DCA group 1–16 individually.

## Using the Focus Recall function

“Focus Recall” is a function that lets you specify the scene parameters that will be recalled (loaded) when you recall a scene. You can specify these settings for each scene. This function is useful if you want to recall only the input channel settings of a specific scene.

### NOTE

In contrast to Focus, the QL series console also features a “Recall Safe” function that enables you to exclude specific channels and parameters from recall operations. However, while the Focus Recall function is specified individually for each scene, the Recall Safe settings are applied to all scenes.

### STEP

1. Press the SCENE field in the Function Access Area.
2. Press the FOCUS tab at the bottom of the SCENE LIST window.
3. In the SCENE LIST window, press the SET button for the scene you want to set.
4. Follow the procedure starting with step 3 in the “Using the Recall Safe function” on page 61 to make settings.
5. Recall a scene for which you have made Focus Recall settings.

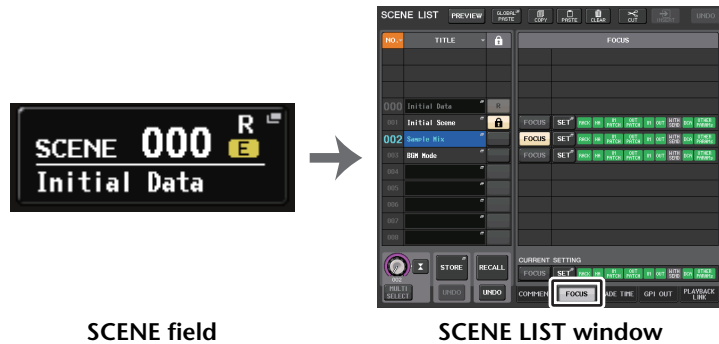

SCENE field

SCENE LIST window

### NOTE

- The FOCUS field enables you to make settings for the Focus function. The buttons in this field correspond to the scene list shown on the left side of the SCENE LIST window.
- Scenes for which Focus settings are made are indicated by a “FOCUS” indication in the STATUS field of the SCENE LIST window.
- You can use the Focus function in conjunction with the Recall Safe function. Channels or parameters that are excluded from Recall operations by either Focus or Recall Safe will not be recalled.

## SCENE LIST window

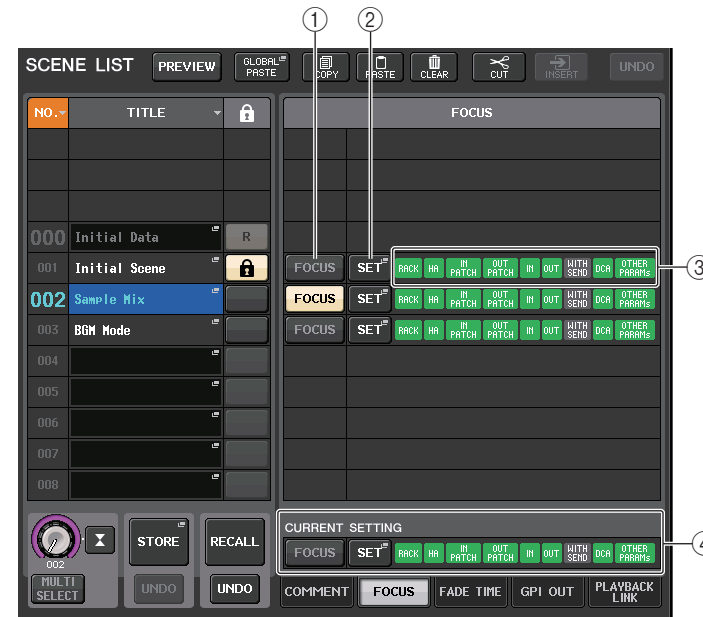

- 1 **FOCUS button**  
Enables or disables the Focus function for each scene.
- 2 **SET popup button**  
Press this button to access the FOCUS RECALL popup window, which allows you to select the parameters that will be subject to recall.
- 3 **FOCUS PARAMETER indicators**  
These indicators show the focus recall settings that are specified for each scene.
- 4 **CURRENT SETTING field**  
Specifies the content that will be saved by the next scene store operation.

## FOCUS RECALL window

Sets the parameters that will be recalled.

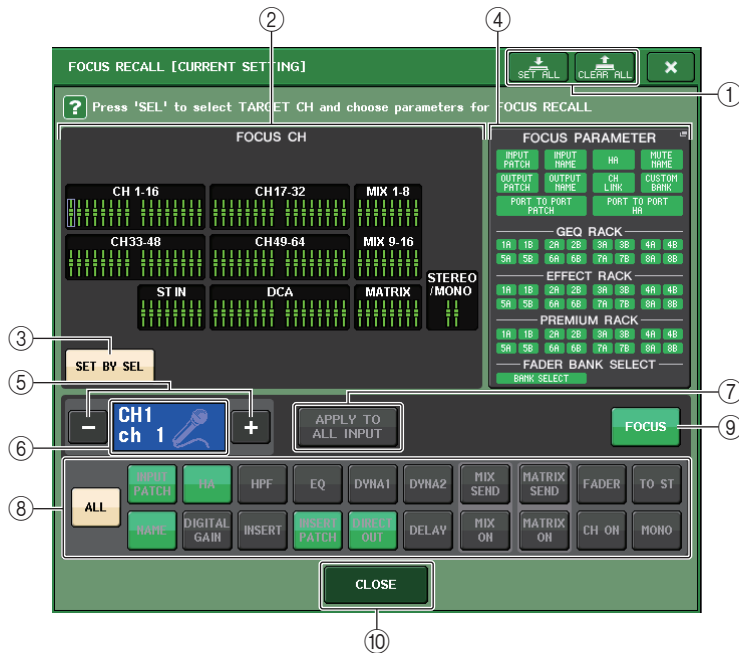

① **CLEAR ALL button/SET ALL button**

Turns off (or on) all focus channel selections and global focus parameter settings.

② **Focus channel display field**

Indicates the target channel for a Recall operation. The view of this field is the same as that in the RECALL SAFE window.

 All parameters are affected by Recall on these channels.

 Some parameters are affected by Recall on these channels.

 Recall has been canceled on these channels.

③ **SET BY SEL button**

Turn on this button to add a channel by using the corresponding [SEL] key. To add channels as the target, turn on this button, and then press the corresponding [SEL] keys for the channels you want to add.

Press the same [SEL] key once again to de-select the channel.

**NOTE**

In the case of QL1, channels that do not exist on the model will not be shown.

④ **FOCUS PARAMETER display field**

Indicates the parameters and racks that will be affected by Recall operations for any scene. Procedures and contents are the same as those in the RECALL SAFE MODE window (page 61).

⑤ **Channel select button**

Selects the channel for which you want to set the Focus Recall function.

**NOTE**

Switching channels using this button will not affect the channel selection on the top panel.

⑥ **Selected channel display**

This area indicates the icon, number, color, and name of the currently-selected channel.

⑦ **APPLY TO ALL INPUT button (input channels only)**

Turn on this button to apply the Focus Recall parameter selection for one input channel to all other input channels.

This can be convenient if you want to apply Focus Recall to the same parameters for all input channels.

⑧ **Recall parameter select button**

Selects Focus Recall parameters for the selected channel.

Enables you to select parameters for each channel that will be affected by Recall operations. You can use the same procedure as that in the RECALL SAFE MODE window (page 61).

⑨ **FOCUS button**

Switches the Focus Recall function on or off.

⑩ **CLOSE button**

Closes the window.

## Using the Fade function

“Fade” is a function that smoothly changes the faders of specified channels and DCA groups to their new values over a specified duration when you recall a scene. The settings of the Fade function are made independently for each scene.

### STEP

1. Press the SCENE field in the Function Access Area.
2. Press the FADE TIME tab at the bottom of the SCENE LIST window.
3. In the SCENE LIST window, press the SET button for the scene you want to set.
4. Press the [SEL] keys for the channels or DCA groups to select the channels or DCA groups to which the Fade effect will be applied (multiple selections are allowed).
5. Use the [TOUCH AND TURN] knob to adjust the fade time.
6. Press the OK button to close the FADE TIME window.
7. Press the FADE button in the SCENE LIST window to enable the Fade function.
8. Recall a scene for which the Fade function is turned on.  
The faders will begin to move immediately after Recall occurs, and will reach the values of the recalled scene over the course of the specified fade time.

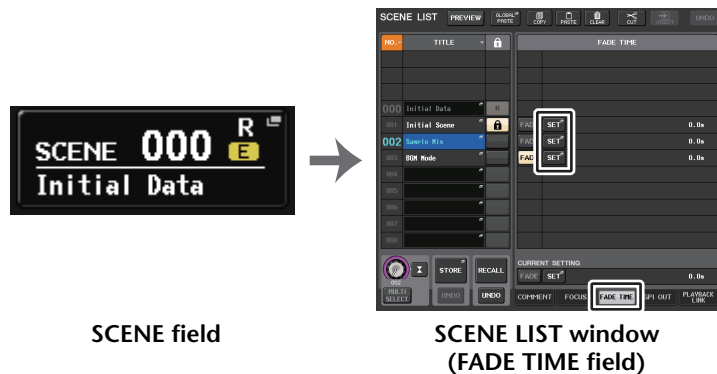

SCENE field

SCENE LIST window  
(FADE TIME field)

### NOTE

- Scenes for which the Fade settings are made are marked by a “FADE” indicator in the STATUS field of the SCENE LIST window (COMMENT tab).
- The Fade function settings can be applied individually even if faders are linked by Channel Link.
- You can stop a fade effect by holding down a [SEL] key while you stop the corresponding moving fader.
- If you recall the same scene while faders are moving, the faders of all channels or DCA groups will move immediately to their target positions.

## SCENE LIST window (FADE TIME field)



- ① **SET button**  
Press this button to open the FADE TIME window, in which you can select a channel for which you want to use the Fade function, and specify the fade time (the duration of time over which the fader will reach its new value).
- ② **FADER button**  
Enables or disables the Fade function for each scene.
- ③ **FADE TIME display**  
This area indicates the fade time specified for each scene.
- ④ **CURRENT SETTING field**  
Specifies the content that will be saved by the next scene store operation.

## FADE TIME window

You can select the channels to which Fade will be applied, and adjust the fade time. To display this window, press the SET button in the FADE TIME field in the SCENE LIST window.

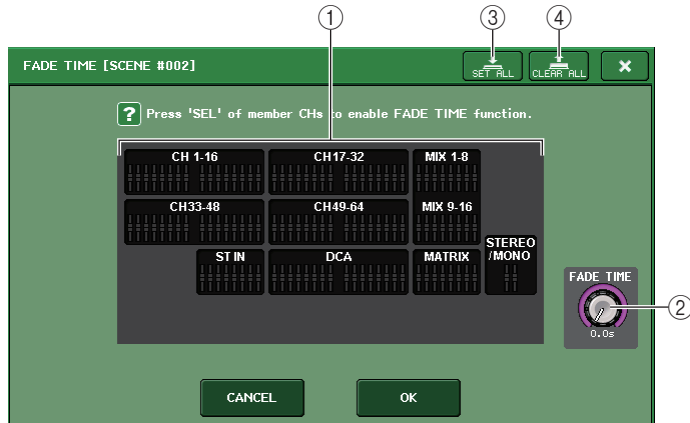

### ① Channel display field

The channels or DCA groups to which Fade is applied are highlighted. To select the channels or DCA groups to which Fade is applied, press the [SEL] keys for the channels or DCA groups. Press the same [SEL] key once again to de-select the channel.

### ② FADE TIME knob

Sets the fade time. You can use the [TOUCH AND TURN] knob to adjust the values. The range is 0.0 sec – 60.0 sec.

#### NOTE

The fade time is used for all channels and DCA groups selected in the channel display field.

### ③ SET ALL button

Press this button to apply the Fade effect to all faders of that scene.

### ④ CLEAR ALL button

Press this button to cancel the Fade function for all faders of that scene.

#### NOTE

In the case of the QL1, faders that do not exist on the model will not be shown.

## Outputting a control signal to an external device in tandem with scene recall (GPI OUT)

A control signal can be output to an external device connected to the GPI connector of the QL series console when you recall a specific scene. Proceed as follows.

#### NOTE

For more information on GPI OUT settings, refer to “Using GPI OUT” on page 204.

#### STEP

1. Press the SCENE field in the Function Access Area.
2. Press the GPI OUT tab at the bottom of the SCENE LIST window.
3. For each scene, specify the control signal that you want to output to each GPI OUT port.
4. Recall the scene for which you want to output GPI OUT signals.



SCENE LIST window  
(GPI OUT field)

## SCENE LIST window (GPI OUT field)



### ① GPI OUT CONTROL buttons

These specify the control signal will be output from each GPI OUT. Pressing a button repeatedly will switch between the following functions.

- ---- (OFF)..... Nothing will be output.
- TRIGGER..... A trigger will be output when the scene is recalled.
- TALLY ..... A tally will be output when the scene is recalled.

### ② CURRENT SETTING field

Specifies the content that will be saved by the next scene store operation.

## Playing back an audio file that links to a scene recall

You can also specify an audio file that you want to play back from a USB flash drive when a specific scene is recalled. This can be convenient if you want an effect sound or BGM to be played automatically in a specific scene.

### NOTE

- Save audio files for playback in the SONGS folder within the YPE folder. If you save them in the root directory or in other folders, you will be unable to specify them for playback. When an audio file is played, the path in the TITLE LIST screen will indicate \YPE\SONGS\.
- You cannot play audio files during recording or in recording standby mode.
- A specified audio file will be played back only once, regardless of the playback mode settings.
- Audio file names must be eight characters plus three extension characters. If you change the file name after specifying the file for playback, or if you delete or copy the file repeatedly, the specified file may become unrecognizable in rare cases.

### STEP

1. Connect a USB flash drive that contains the audio files to the USB connector.
2. Press the SCENE field in the Function Access Area.
3. Press the PLAYBACK LINK tab at the bottom of the SCENE LIST window.
4. Press the song select button for a scene to which you want to link the audio file.
5. Press the SONG SELECT window or use the [TOUCH AND TURN] knob to select a file that you want to link to a scene.
6. Use the [TOUCH AND TURN] knob to set the offset (the time duration until the start of audio file playback).
7. Press the OK button.
8. Press the PLAY button to turn on the link to the audio file.
9. Recall a scene to which an audio file has been linked.

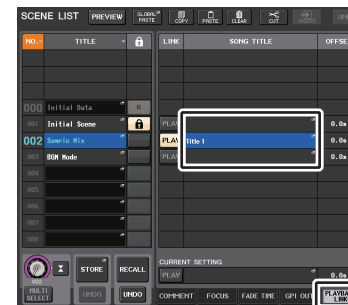

SCENE LIST window (PLAYBACK LINK field)

**NOTE**

- After a scene has been recalled and until the offset time has elapsed, a countdown will appear in the Function Access Area.
- If another song is playing during a scene recall, the song playback will stop when the scene is recalled, regardless of the offset time setting.

**SCENE LIST window (PLAYBACK LINK field)**



- 1 PLAY button**  
Sets the Playback Link function's on/off status for each scene.
- 2 Song select button**  
Press this button to open the SONG SELECT window, in which you can select a song and set the offset time (time duration from scene recall until the start of playback). Also, the title of the selected song will appear on the button.
- 3 Offset time display**  
Indicates the time duration from scene recall until the start of playback of the specified audio file. Set the offset time in the SONG SELECT window.
- 4 CURRENT SETTING field**  
Specifies the content that will be saved by the next scene store operation.

**SONG SELECT window**

You can select an audio file you want to link with the scene, and set the offset time. This window will appear when you press the song select button.

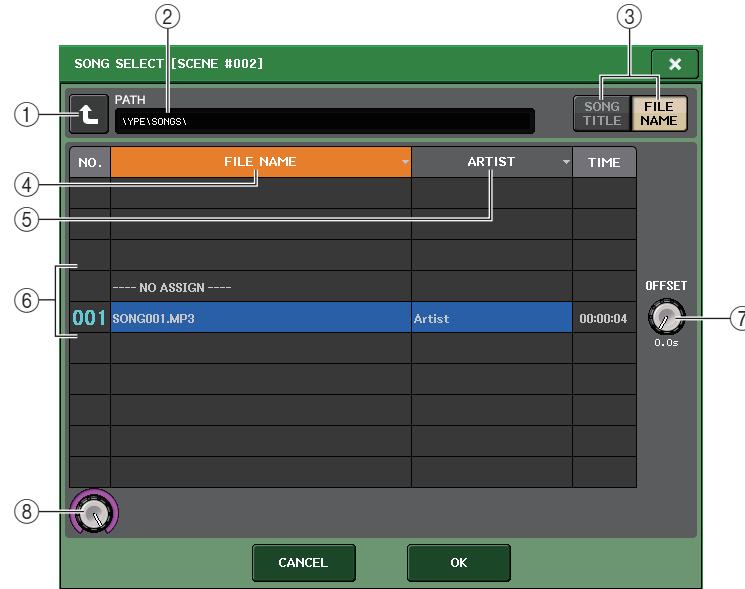

- 1 Change directory button**  
Press this button to move to the next higher folder level.
- NOTE**  
You cannot move to levels higher than \YPE\SONGS\.
- 2 PATH indicator**  
This area indicates the current directory path.
  - 3 SONG TITLE/FILE NAME switch buttons**  
Switch between the song title list and the file name list.
  - 4 SONG TITLE list button**
  - 5 ARTIST list button**  
Press these buttons to sort the audio file list (at the current directory level) by song title and artist name respectively.
  - 6 Song list**  
Displays the title, artist name, and audio file time duration of the audio files in the \YPE\SONGS\ folder. You can select an audio file by pressing the audio file name.



**⑦ OFFSET knob**

You can use the [TOUCH AND TURN] knob to set the time duration from scene recall until the start of audio file playback. The offset value can be adjusted in the range of 0.0 – 99.0 in 0.5 sec steps.

**⑧ Scroll knob**

Use the [TOUCH AND TURN] knob to scroll the list.

## Using Preview mode

Preview mode lets you view or edit the settings of a scene stored in memory without affecting the signal processing of the current scene. When you recall a scene in this mode, the settings of the newly recalled scene will appear on the panel of the QL series console, but the signal processing of the current scene will remain as it was prior to the recall. Even if you modify the settings and save them as a new scene or by overwriting, the signal processing of the current scene will remain as it was prior to the recall. During an actual performance, it can be convenient to use this to check the content of the scene you intend to recall next, or to make minor changes to a scene and then store it.

---

### STEP

1. Press the PREVIEW button in the SCENE LIST window.
  2. Use the [TOUCH AND TURN] knob to operate the SCENE SELECT knobs in the SCENE LIST window, and select the scene number that you want to recall.
  3. Press the RECALL SCENE button in the SCENE LIST window. To execute the Recall operation, press the OK button.
  4. If desired, use the panel controls to edit the settings.
  5. If you want to store the changes you made in step 4, select the scene number in which you want to store the scene, and press the SCENE MEMORY [STORE] key in the SCENE LIST window.
  6. When you have finished viewing or editing the settings of the scene, press the PREVIEW button in the SCENE LIST window.
- 

**NOTE**

PREVIEW mode applies to all parameters included in scene memory, all parameters included in the INPUT PATCH and OUTPUT PATCH functions, and HA parameters.

## Functions in Preview mode

The current scene will be modified by the following software and external operations.

- QL Editor
- StageMix
- MIDI Rx
- GPI IN

Similarly, edits for the current scene will be conveyed to the following software and external devices.

- QL Editor
- StageMix
- MIDI Tx
- GPI OUT

The meters will indicate the state of signal processing for the current scene.

Playback Link will operate for recalling the current scene.

If cascade-connected, both master and slave units will operate independently. Link will not occur while in Preview mode.

The following functions will not operate in Preview mode.

- Synchronization with QL Editor
- Switching users
- Changing the User Level
- Load/Save functions
- Cue changes
- USER DEFINED KEYS operations
- USER DEFINED KNOBS operations
- Monitor (MONITOR, CUE, OSCILLATOR, TALKBACK) changes or display
- Changing or viewing Nuendo Live settings
- Changing or viewing the recorder
- Changing DANTE SETUP or DANTE PATCH settings
- FADE TIME
- EFFECT FREEZE playback or recording
- MIDI clock and tap tempo for effects
- Internal metering for Premium Effects (GR for DynamicEQ and Portico 5043; VU for Opt-2A and U76)

In addition, you cannot enter Preview mode while performing the following operations.

- While pasting scene or EQ settings
- While executing Global Paste
- While synchronizing with QL Editor
- While saving/loading a file

**NOTE**

The scene titles shown in StageMix will be changed to the titles used when using the store operation on a QL series console operated in PREVIEW mode.

# Monitor and Cue functions

The Monitor function lets you monitor various outputs through your nearfield monitors or headphones. Below the front panel of the QL series console is a PHONES out jack for monitoring, which enables you to monitor the monitoring source signal at any time. By assigning the MONITOR OUT L/R/C channels to the desired output jacks, you can also monitor the same signal through external speakers.

You can select the following signals as the monitor source.

- STEREO channel output signal
- MONO channel output signal
- STEREO+MONO channel output signal
- INPUT 25-26, 27-28, 29-30, 31-32 (9-10, 11-12, 13-14, 15-16 for the QL1) channel input signal (for monitoring a two channel pair)
- RECORDER PLAYBACK output signal
- A combination of up to eight MIX, MATRIX, STEREO, or MONO channel output signals, RECORDER PLAYBACK output signals, and INPUT 25-26, 27-28, 29-30, 31-32 (9-10, 11-12, 13-14, 15-16 for the QL1) input signals

The Cue function enables you to check an individual channel or DCA group by temporarily monitoring it via MONITOR OUT or PHONES. When you press the [CUE] key on the top panel, the cue signal of the corresponding channel or DCA group is sent as the monitor output from the selected output port.

## NOTE

Be aware that if you turn CUE INTERRUPTION off in the MONITOR popup window, the cue signal will no longer be sent to the connected monitor speakers. However, the cue signal will always be sent to the PHONES Out jack.

The following diagram shows the cue/monitor signal flow.

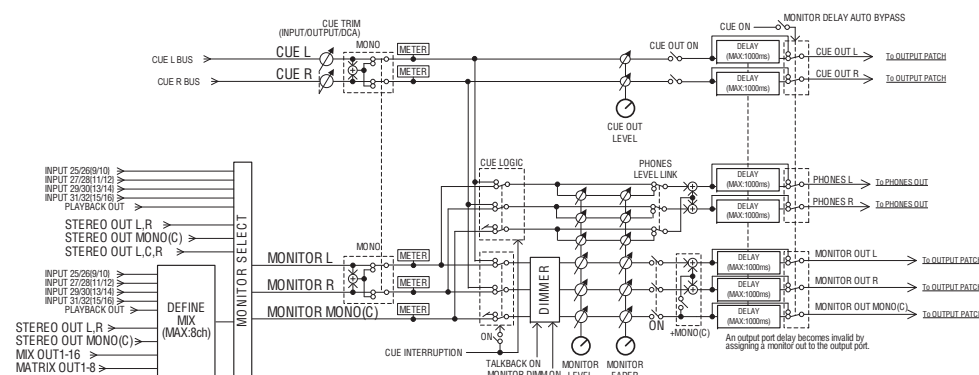

- **MONITOR SELECT**  
Selects the monitor source.
- **METER**  
Detects and indicates the level of the monitor signal or cue signal.
- **DIMMER**  
Attenuates the monitor/cue signal by a fixed amount.
- **MONITOR LEVEL**  
Adjusts the output level of the MONITOR OUT L/R/C channels. If PHONES LEVEL LINK is ON, this setting will also affect the level at the PHONES Out jack.
- **MONITOR FADER**  
Use the STEREO MASTER fader or MONO MASTER fader to adjust the output level of the MONITOR OUT L/R/C channels. MONITOR FADER is positioned in series with MONITOR LEVEL. If PHONES LEVEL LINK is ON, this setting will also affect the level at the PHONES Out jack.
- **ON (On/off)**  
Switches the Monitor function on or off.
- **DELAY (Monitor delay)**  
Delays monitor signals. The Delay function is disabled if cue signals are being output.
- **PHONES LEVEL (Headphone level)**  
Adjusts the dedicated output level of the PHONES Out jack.
- **PHONES LEVEL LINK (Headphone Level Link function)**  
If this function is turned on, the MONITOR LEVEL knob will adjust the level of signals sent to the PHONES Out jack.
- **CUE INTERRUPTION (Cue Interruption function)**  
If this function is turned on, pressing the [CUE] key on the top panel will cause the cue signal of the corresponding channel or DCA group to be sent as the monitor output from the selected output port. With the factory default settings, this function is turned on.  
Turn it off if you do not want to output cue signals to the monitoring speakers.

## Using the Monitor function

This section explains how to select the desired monitor source, and monitor it from the PHONES Out jack or external monitor speakers.

### STEP

1. Connect your monitor system to the OMNI OUT jacks or 2TR OUT DIGITAL jack on the rear panel. To monitor through headphones, connect your headphones to the PHONES Out jack below the front panel.
2. In the Function Access Area, press the MONITOR button.
3. Press the MONITOR display button or the meter field in the MONITOR screen.
4. Use the source select buttons in MONITOR screen to select the monitor source.
5. Press one of the MONITOR OUT PATCH buttons (L/R/C) in the meter field to specify the port that will be the output destination for monitor signals L, R, and C (multiple selections are allowed).
6. Turn the OUTPUT button on to enable monitoring.
7. To adjust the monitor level, set the MONITOR LEVEL control located in the Function Access Area by using the [TOUCH AND TURN] knob.
8. Make settings for Dimmer, Delay, and Monaural as desired.



MONITOR screen

### NOTE

Monitor on/off operations, selection of the monitor source, and dimmer on/off operations can also be assigned to USER DEFINED keys. (page 169)

## MONITOR screen

In the MONITOR screen, the MONITOR field lets you check the current monitor settings, and turn monitoring on or off.

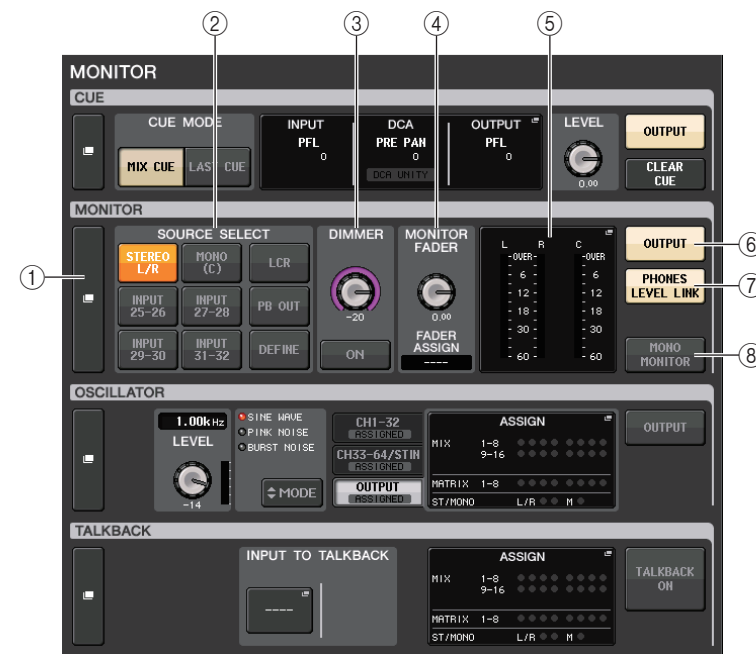

### ① MONITOR display button

When you press this button, the MONITOR window will appear, in which you can make detailed monitor settings.

### ② SOURCE SELECT field

Selects the monitor source. If DEFINE has been selected in this field, access the MONITOR window to specify the source channel.

### ③ DIMMER field

Enables you to make settings for the Dimmer function, which temporarily attenuates monitor signals.

#### • DIMMER LEVEL knob

Adjusts the amount by which the monitor signals will be attenuated when the dimmer is on.

#### • DIMMER ON button

Turn on this button to enable the dimmer and attenuate the monitor signal.

④ **MONITOR FADER field**

Enables you to set and view the monitor fader that adjusts the monitor level.

- **MONITOR FADER LEVEL knob**  
Adjusts the monitor fader level.
- **FADER ASSIGN display**  
This area displays the type of faders that are currently assigned to the monitor fader. Indicator assignments are as follows.
  - --- ..... No assignment
  - **MASTER A**..... Master A only
  - **MASTER A+** ..... Master A, Master B, Custom fader bank
  - **MASTER B**..... Master B only
  - **MASTER B+** ..... Master B, Custom fader bank
  - **CUSTOM**..... A single fader in the Custom fader bank
  - **CUSTOMs**..... Multiple faders in the Custom fader bank

⑤ **Meter field**

Indicates the output level of Monitor Out channels L, R, and C. Press this field to open the MONITOR window.

⑥ **MONITOR OUTPUT button**

Switches the Monitor Output on or off.

⑦ **PHONES LEVEL LINK button**

If this is on, the MONITOR FADER LEVEL knob or MONITOR FADER will adjust the level of signals sent to the PHONES Out jack.

⑧ **MONO MONITOR button**

Turn on this button to switch monitor signals to mono.

**MONITOR window**

You can make detailed settings for monitoring. This screen appears when you press the MONITOR display button or the meter field in the MONITOR screen.

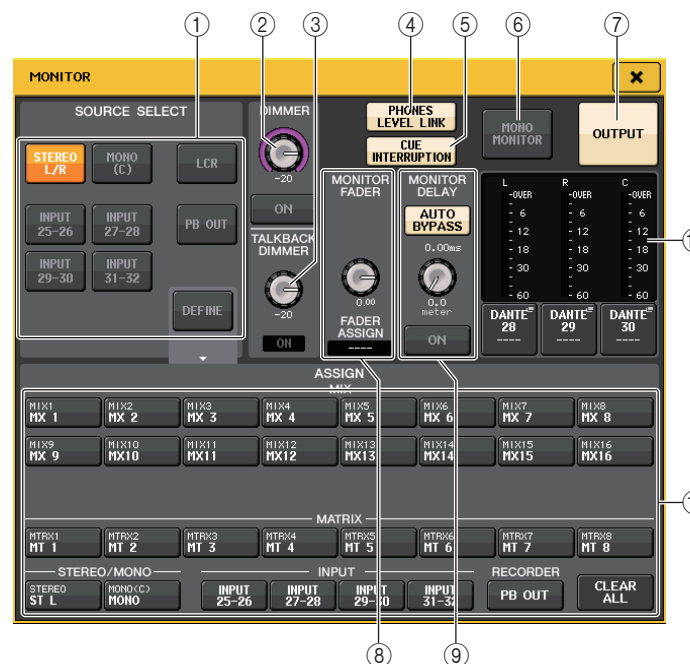

① **SOURCE SELECT field**

Select one of the following as the signal source that will be output to the MONITOR bus.

STEREO L/R	STEREO L/R channel signals
MONO (C)	MONO channel signal
LCR	STEREO L/R + MONO channel signals
INPUT 25-26-31-32*1	INPUT jacks 25-32*2 signals (per two channels)
PB OUT	Recorder's PLAYBACK OUT signals
DEFINE	The signal(s) selected in the ASSIGN field
LINK	Links the monitor source with the MIX/MATRIX bus selected in SENDS ON FADER mode.

\*1. QL1: 9-10-15-16

\*2. QL1: 9-16

② **DIMMER field**

Enables you to make settings for the Dimmer function, which temporarily attenuates monitor signals.

• **DIMMER LEVEL knob**

Adjusts the amount by which the monitor signals will be attenuated when the dimmer is on.

• **DIMMER ON button**

Switches the Dimmer function on or off. The monitor signal will be attenuated if this button is on.

③ **TALKBACK DIMMER field**

Enables you to make settings for the Dimmer function, which temporarily attenuates monitor signals when TALKBACK is on.

• **TALKBACK DIMMER LEVEL knob**

Adjusts the amount by which the monitor level will be attenuated when talkback is on.

• **TALKBACK DIMMER ON indicator**

Indicates the on/off status of the dimmer function for talkback.

④ **PHONES LEVEL LINK button**

Enables you to link the signal level at the PHONES Out jack to the monitor signal level. If this button is on, the MONITOR FADER LEVEL knob and monitor fader will adjust the level of the signal sent to the PHONES OUT jack.

⑤ **CUE INTERRUPTION button**

Press this button to interrupt the monitor signal by the cue signal. If this button is on and the cue is enabled, the cue signal will be sent to the monitor output. With the factory default settings, this function is turned on. If you do not wish to send the cue signal to the monitor output, switch this button off.

⑥ **MONO MONITOR button**

Turn on this button to switch the monitor output signal to mono.

⑦ **MONITOR OUTPUT button**

Switches the monitor output on or off.

⑧ **MONITOR FADER field**

Enables you to set and view the monitor fader that adjusts the monitor level.

• **MONITOR FADER LEVEL knob**

Adjusts the monitor fader level. You can use the [TOUCH AND TURN] knob to adjust the monitor level.

• **FADER ASSIGN display**

This area displays the type of faders that are currently assigned as MONITOR FADER. Indicator assignments are as follows.

----	No assignment
<b>MASTER A</b>	MASTER A fader only
<b>MASTER A+</b>	MASTER A, as well as MASTER B fader and Custom fader bank
<b>MASTER B</b>	MASTER B fader only
<b>MASTER B+</b>	MASTER B, as well as Custom fader bank
<b>CUSTOM</b>	One of the Custom fader bank faders
<b>CUSTOMs</b>	Multiple Custom fader bank faders

⑨ **MONITOR DELAY field**

This field enables you to specify the monitor delay setting by which the monitor out signal is delayed.

• **AUTO BYPASS button**

Turn this on to automatically bypass monitor delay when the cue is on.

• **MONITOR DELAY knob**

Adjusts the delay time for the monitor signal. The delay time is shown above the knob in ms units, and below the knob in units of the currently-selected scale. However if the scale is set to ms, the delay time value is not shown above the knob.

If you press this knob, you can use the [TOUCH AND TURN] knob to adjust the value.

• **MONITOR DELAY ON button**

If this button is on, the monitor signal will be delayed according to the setting of the MONITOR DELAY knob.

⑩ Meter field

• Meters

Indicates the output level of the monitor L/R/C channels.

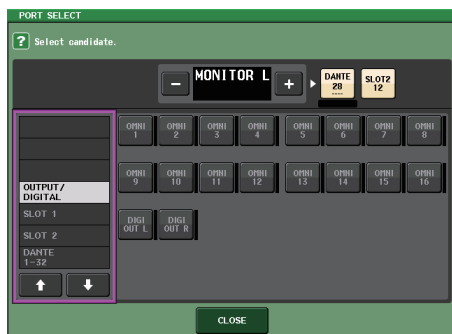

DANTE1-64*1	Output channels 1-64 to audio network*1
OMNI1-16*2	OMNI OUT jacks 1-16*2
DIGI OUT L/R	DIGITAL OUT jack on the QL unit
SLOT1-1-SLOT2-16	Output channels 1-16 of an I/O card installed in slots 1-2

\*1. QL1: 1-32

\*2. QL1: 1-8

**NOTE**

- You can specify output ports only for MONITOR OUT L and R, and monitor through two speakers.
- If you have not specified an output port for MONITOR OUT C, selecting the MONO (C) button or LCR button as the monitor source will automatically cause the MONO channel signal to be distributed to MONITOR OUT L/R.

⑪ ASSIGN field

If you have selected DEFINE in the SOURCE SELECT field, you can use the ASSIGN field to specify multiple monitor sources. The following table shows the monitor sources that you can select in the ASSIGN field.

MIX 1-16	MIX channels 1-16 output signals
MTRX 1-8	MATRIX buses 1-8 output signals
STEREO	STEREO L/R channel output signals
MONO (C)	MONO channel output signal
PB OUT	Recorder's PLAYBACK OUT signals
INPUT 25-26-31-32*1	INPUT jacks 25-32*2 signals (per two channels)

\*1. QL1: 9-10-15-16

\*2. QL1: 9-16

**NOTE**

You can select a maximum of eight monitor sources in the ASSIGN field. If you select eight monitor sources, no further selections will be possible. Turn off the buttons of unneeded sources.

## Using the Cue function

### About CUE groups

Cue signals on the QL series console can be categorized into the following four groups.

① INPUT CUE group

The cue signals of input channels make up this group. To enable cue for this group, press the [CUE] key for any input channel to turn cue on.

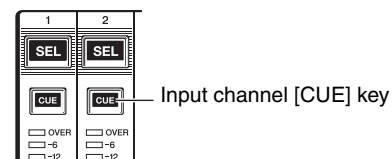

② DCA CUE group

The cue signals of DCA groups make up this group. To enable cue for this group, press the [CUE] key of one of the DCA groups to turn cue on.

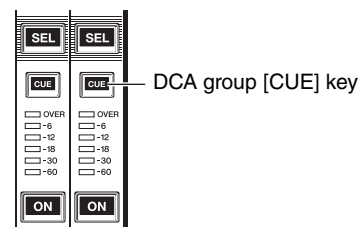

③ OUTPUT CUE group

The cue signals of output channels make up this group. To enable cue for this group, press the [CUE] key of one of the output channels.

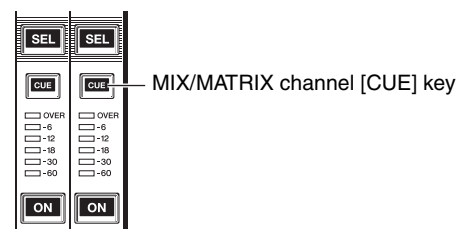
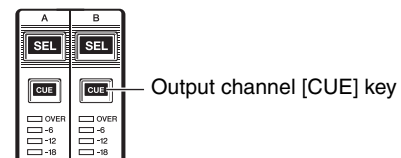

#### ④ Other CUE group

These cue signals are operated via buttons displayed on the touch screen. This group is enabled if you turn on the CUE button in the EFFECT window or the PREMIUM window, or if you turn on the KEY IN CUE button in the DYNAMICS 1 window. This group will automatically be disabled when you exit the corresponding window.



On-screen CUE button

#### NOTE

You cannot turn on cue monitoring between different groups simultaneously. Normally, the group to which the most recently-pressed [CUE] key (or on-screen CUE/KEY IN CUE button) belongs will take priority, and the [CUE] keys for the previously-selected group will be defeated.

However, if you have switched the cue signal group in a specific order when the CUE MODE setting is MIX CUE, the state of the [CUE] keys for the previously-selected group will be restored when the current cue signal is defeated.

The right illustration shows the priority order of the [CUE] keys. After you have switched groups from lower to upper levels, if you then defeat cue for the upper group, the previous [CUE] key status of the group immediately below will be restored.

For example, if you switch groups in the order of OUTPUT CUE group → DCA CUE group → INPUT CUE group → Other CUE group, you can then successively defeat the [CUE] keys (CUE/KEY IN CUE buttons) to successively restore the [CUE] key status of the previously-selected group.

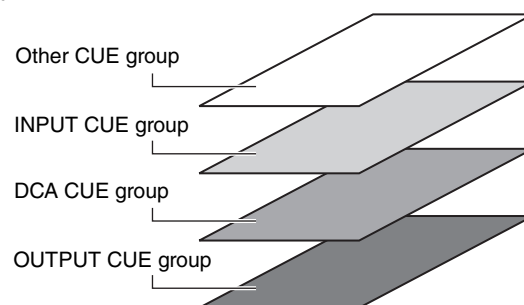

## Operating the Cue function

This section explains how to use the [CUE] key for a channel or DCA group to monitor cue signals.

#### NOTE

Be aware that if you turn CUE INTERRUPTION off in the MONITOR popup window, the cue signal will not be sent to the connected monitor speakers. However, the front panel PHONES jack will always output the cue signal regardless of the Monitor on/off setting. See “Using the Monitor function” on page 88 for details about the Monitor function.

#### STEP

1. In the Function Access Area, press the MONITOR button.
2. Press the CUE display button or the INPUT/DCA/OUTPUT CUE field in the MONITOR screen.
3. Use the CUE MODE button to select either the mode in which channels are mixed for auditioning, or the mode in which only the last-selected channel is auditioned.
4. Use the buttons and knobs of the INPUT CUE/DCA CUE/OUTPUT CUE field to specify the output position and output level for each CUE group.
5. Press one of the CUE OUT PATCH buttons (L/R) in the meter field to specify a port as the output destination for cue signals L and R (multiple selections are allowed).
6. To enable cue out for the port you specified in step 5, press the CUE OUTPUT button to turn it on.
7. Press the [CUE] key of the channel or DCA group to be monitored to turn it on.
8. Adjust the cue signal level by using the [TOUCH AND TURN] knob to operate the CUE LEVEL knobs in the CUE field.
9. To defeat cue, press the currently-on [CUE] key once again. To clear all cue selections, press the CLEAR CUE button in the Meter field.



MONITOR screen



**NOTE**

- The cue signal is sent to the monitor output and PHONES Out jacks regardless of whether the CUE OUTPUT button is on or off. However, the cue signal will no longer be sent to monitor output if CUE INTERRUPTION is turned off. The cue signal is always sent to the PHONES Out jack, regardless of the CUE INTERRUPTION setting.
- When using the MIX/MATRIX bus select buttons in the SENDS ON FADER window, you can press the selected button once again to turn on cue for the corresponding MIX/MATRIX channel (page 36).
- If you want cue operations and channel select operations to be linked, open the USER SETUP window, choose the PREFERENCE tab, and then turn on [CUE]→[SEL] LINK (page 168).
- You can also assign the function of the CLEAR CUE button to a USER DEFINED key (page 169).
- If PHONES LEVEL LINK (page 89) in the MONITOR screen is ON, the cue signal level when monitoring through headphones can be adjusted using both the MONITOR LEVEL knob and the PHONES LEVEL knob.
- To adjust the level to the output destination port for the cue signal, adjust the gain of the output port that is patched to it.
- If you turn on the [CUE] key, the cue output level is indicated. The upper part of the cue meter shows an abbreviation indicating the currently-on cue group or cue button. The abbreviations displayed for the cue meters have the following meaning.

IN	INPUT CUE group
DCA	DCA CUE group
OUT	OUTPUT CUE group
EFFECT	CUE button in the EFFECT and PREMIUM RACK windows (Other CUE groups)
KEY IN	KEY IN CUE button in the DYNAMICS1 window (Other CUE groups)

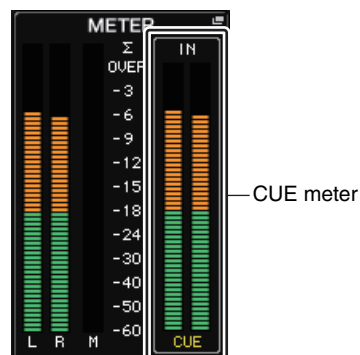

CUE meter

**MONITOR screen**

The CUE field on the MONITOR screen enables you to check the current cue settings, and turn cue on or off.

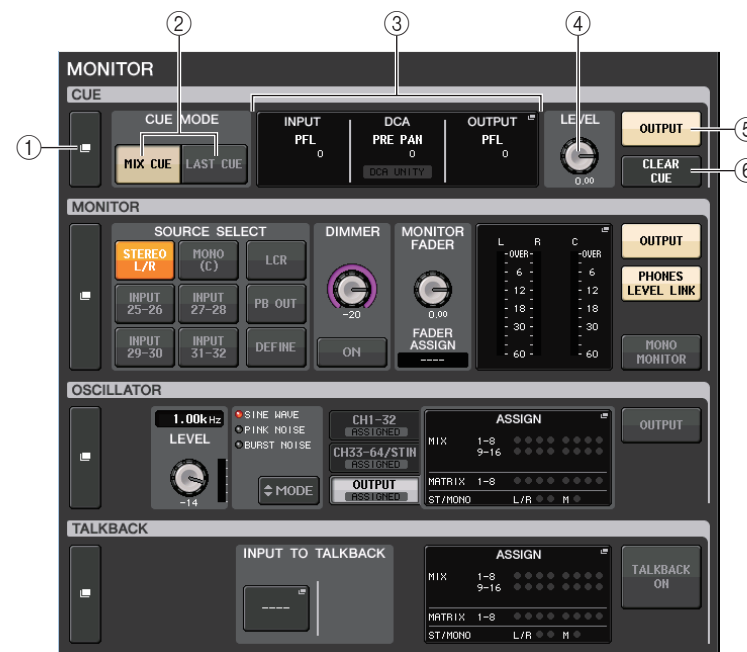
① **CUE display button**

When you press this button, the CUE window will appear, in which you can make detailed cue settings.

② **CUE MODE buttons**

Select the cue mode. You can select MIX CUE mode (all selected channels will be cued), or LAST CUE mode (only the channel selected most recently will be cued).

③ **INPUT/DCA/OUTPUT CUE section**

Indicates the settings for input cue, DCA cue, and output cue. Press this field to open the CUE window.

④ **CUE LEVEL knob**

Indicates the output level of the cue out. You can use the [TOUCH AND TURN] knob to adjust the level.

⑤ **CUE OUTPUT button**

Switches the cue output on or off.

⑥ **CLEAR CUE button**

Cancels all cue selections simultaneously. If MIX CUE mode has been selected, all of the selected channels will be cleared.

## CUE window

You can make detailed settings for the cue. This screen appears when you press the INPUT/DCA/OUTPUT CUE field.

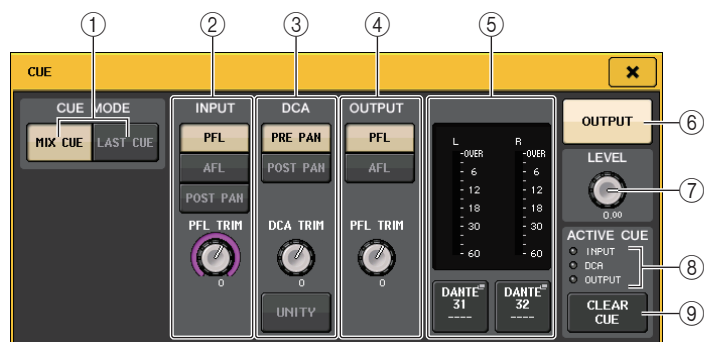
① **CUE MODE buttons**

Select one of the following two cue modes:

- **MIX CUE**  
All selected channels will be mixed and auditioned.
- **LAST CUE**  
Only most recently selected channel will be auditioned.

② **INPUT CUE field**

This field enables you to make settings related to the input channel cue.

- **Cue point select button**  
Sets the cue point to PFL (before the fader (immediately before INPUT DELAY)), AFL (immediately after the fader), or POST PAN (immediately after PAN).

### NOTE

Be aware that if you turn on the POST PAN button, you will be unable to monitor signals sent to the MONO bus from an input channel in LCR mode.

- **PFL TRIM knob**  
Specifies the monitor levels when PFL is selected. You can use the [TOUCH AND TURN] knob to adjust the level.

③ **DCA CUE field**

This section enables you to make settings related to DCA cue.

- **Cue point select button**  
Sets the cue point for the DCA group to PRE PAN (immediately before PAN) or POST PAN (immediately after PAN).
- **DCA TRIM knob**  
Indicates the monitor level of cue signals from a DCA group. You can use the [TOUCH AND TURN] knob to adjust the level.
- **UNITY button**  
Turn on this button to monitor signals at the same volume level that was obtained when the master level for each DCA group was set to 0 dB (unity gain).

④ **OUTPUT CUE field**

This section enables you to make settings related to output channel cue.

- **Cue point select button**  
Sets the cue point for the output channel to PFL (immediately before fader) or AFL (immediately after fader).
- **PFL TRIM knob**  
Indicates the monitor levels when PFL is selected. If you press this knob, you can use the [TOUCH AND TURN] knob to adjust the level.

⑤ **Meter field**• **Meter**

This field indicates the output level of the cue L/R channels.

• **CUE OUT PATCH button**

Press this button to open the PORT SELECT popup window, in which you can select an output port to patch to the cue out L/R channels.

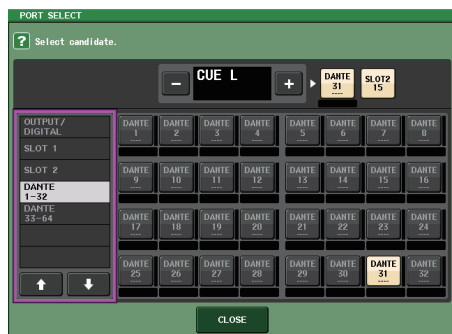

DANTE1-64* <sup>1</sup>	Output channels 1-64 to audio network* <sup>1</sup>
OMNI1-16* <sup>2</sup>	OMNI OUT jacks 1-16* <sup>2</sup>
DIGI OUT L/R	DIGITAL OUT jack on the QL unit
SLOT1-1-SLOT2-16	Output channels 1-16 of an I/O card installed in slots 1-2

\*1. QL1: 1-32

\*2. QL1: 1-8

⑥ **CUE OUTPUT button**

Switches cue out on or off.

⑦ **CUE LEVEL knob**

Indicates the output level of the cue out. You can use the [TOUCH AND TURN] knob to adjust the level.

⑧ **ACTIVE CUE indicator**

Lights to indicate the type of cue currently being monitored (input: blue, DCE: yellow, output: orange).

⑨ **CLEAR CUE button**

Press this button to clear all cue selections simultaneously.

# Talkback and Oscillator

Talkback is a function that sends the signal of the selected INPUT jack to the desired bus. This is used mainly to convey instructions from the operator or sound engineer to the performers and staff.

QL series consoles also feature an oscillator that can output a sine wave or pink noise to the desired bus, so that you will be able to check external equipment or to test the acoustical response of the room or hall.

The diagram below shows the signal flow of the talkback and oscillator signals.

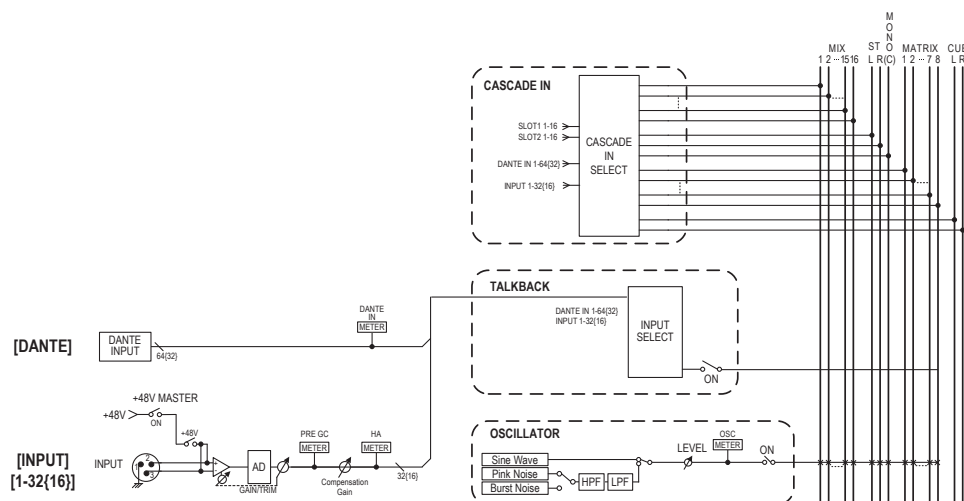

## Using Talkback

The Talkback function sends the signal (that is input at the input jacks) to the desired bus.

### STEP

1. In the Function Access Area, press the **MONITOR** button.
2. Press the **TALKBACK** display button or the **ASSIGN** field in the **MONITOR** screen.
3. Connect a mic to the **INPUT** jack on the rear panel.
4. Press a button in the **ASSIGN** field in the **TALKBACK** window to specify the bus(es) to which the talkback signal will be sent (multiple selections are allowed).
5. To enable talkback, press the **TALKBACK ON** button to turn it on.
6. Press the **INPUT TO TALKBACK** button to select an input. Use the **[TOUCH AND TURN]** knob to adjust the volume.



MONITOR screen

### NOTE

- The PAD will be switched on or off internally when the HA gain is adjusted between +17 dB and +18 dB.
- Keep in mind that noise may be generated when using phantom power if there is a difference between the Hot and Cold output impedance of an external device connected to the INPUT jack.
- You can also assign talkback on/off or an ASSIGN change to a USER DEFINED key. In this case, you can select either a Latch operation or an Unlatch operation (the function will be enabled only while you continue holding down the key) ([page 169](#)).
- When talkback is on, you can use the talkback dimmer to lower the monitor levels other than the talkback signal ([page 90](#)).

## MONITOR screen

In the MONITOR screen, the TALKBACK field enables you to check the current talkback settings, and turn talkback on or off.

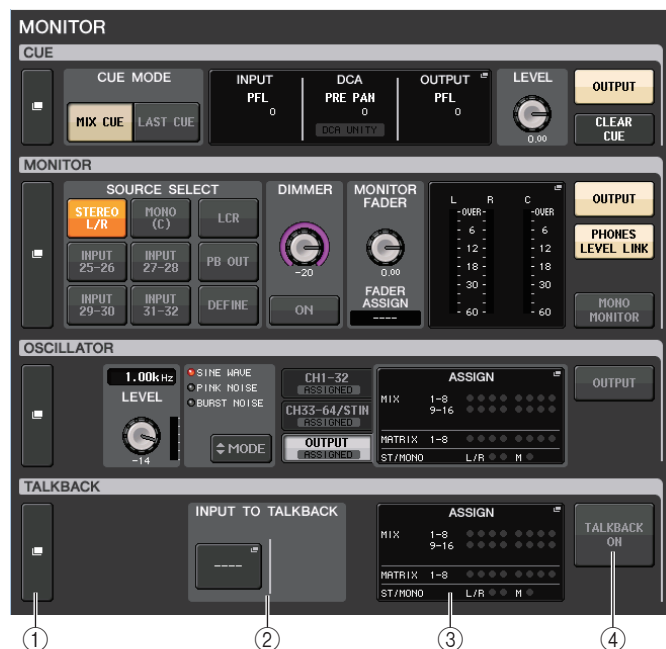

### ① TALKBACK display buttons

When you press this button, the TALKBACK screen will appear, in which you can make detailed talkback settings.

### ② INPUT TO TALKBACK field

#### • INPUT TO TALKBACK patch button

..... Press the button to open the PORT SELECT window, in which you can patch a desired input port to talkback. The selected port name will appear on the button.

- **INPUT GAIN knob**..... Sets the input gain of the selected port.
- **Input level meter**..... Indicates the level of signals after the input gain.

### ③ TALKBACK ASSIGN field

An indicator lights to indicate the currently-selected output destination of the talkback signal.

### ④ TALKBACK ON button

Switches talkback on or off.

## TALKBACK window

Press the TALKBACK popup display button or the ASSIGN field to open the TALKBACK popup window. In this popup window you can make detailed settings for talkback.

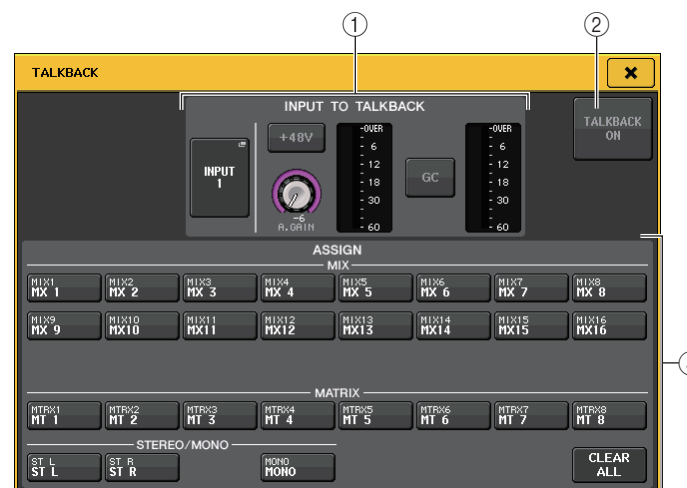

### ① INPUT TO TALKBACK field

This field allows a mic connected to a conventional input port to be used as a talkback input.

#### • INPUT TO TALKBACK patch button

Press the button to open the PORT SELECT popup window, in which you can patch a desired input port to talkback. The selected port name will appear on the button.

#### • +48V button

This is an on/off switch for the phantom power (+48V) supplied to the selected input port.

#### • ANALOG GAIN knob

Adjusts the analog gain setting for the selected input port. If you press this knob, you can use the [TOUCH AND TURN] knob to adjust the gain.

#### • HA meter

Indicates the input level of a mic connected to the selected input port.

#### • GC ON button

Turns the Gain Compensation (gain correction function) on or off. The button will appear if the input jack of an I/O device is patched.

#### • Gain Compensation meter

Indicates the level after Gain Compensation. It will appear if the input jack of an I/O device is patched.

### NOTE

These parameters and meters will not appear if no input port is selected.

- ② **TALKBACK ON** button  
Switches talkback on or off.
- ③ **ASSIGN** field
  - **Channel select buttons**  
Enable you to select a channel (bus) on which the talkback signal is sent.
  - **CLEAR ALL** button  
Press this button to clear all selections.

## Using the Oscillator function

You can send a sine wave or pink noise from the internal oscillator to the desired bus.

### STEP

1. In the Function Access Area, press the MONITOR button.
2. Press the OSCILLATOR display button or the ASSIGN field in the MONITOR screen.
3. Press a button in the OSCILLATOR MODE field in the OSCILLATOR window to select the type of signal you want to output.
4. Use the knobs and buttons in the parameter field to adjust the oscillator parameters.
5. Press a button in the ASSIGN field to specify the input channel(s) or bus(es) to which the oscillator signal will be sent (multiple selections are allowed).
6. Press the OUTPUT button to enable the oscillator.



MONITOR screen

## MONITOR screen

In the MONITOR screen, the OSCILLATOR field lets you check the current oscillator settings, and turn the oscillator on or off.

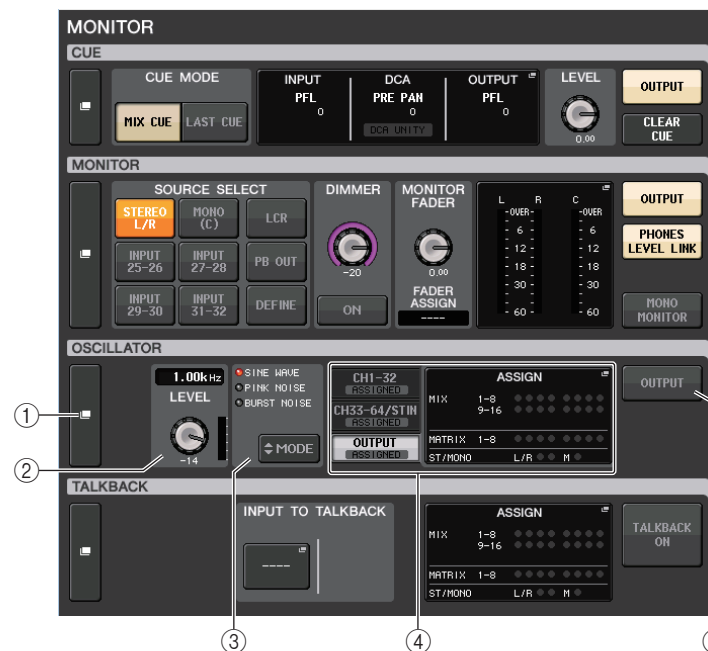

### ① OSCILLATOR display button

When you press this button, the OSCILLATOR screen will appear, in which you can make detailed oscillator settings.

### ② OSCILLATOR LEVEL field

This adjusts the level of the oscillator. A meter beside the LEVEL knob indicates the output level of the oscillator. If OSCILLATOR MODE is set to SINE WAVE, the frequency of the oscillator is shown. If you press the LEVEL knob, you can use the [TOUCH AND TURN] knob to adjust the oscillator level.

### ③ OSCILLATOR MODE field

Indicates the currently-selected oscillator mode. Pressing the MODE button repeatedly will switch modes.

### ④ OSCILLATOR ASSIGN field

An indicator lights to indicate the currently-selected oscillator output destination (input channels or buses). Use the tabs on the left to select channels or buses to display.

### NOTE

In the case of QL1, channels that do not exist on the model will not be shown.

- ⑤ **OSCILLATOR OUTPUT button**  
Turns the oscillator output on or off.

## OSCILLATOR window

You can make detailed settings for the oscillator. This window appears when you press the OSCILLATOR display button in the MONITOR screen.

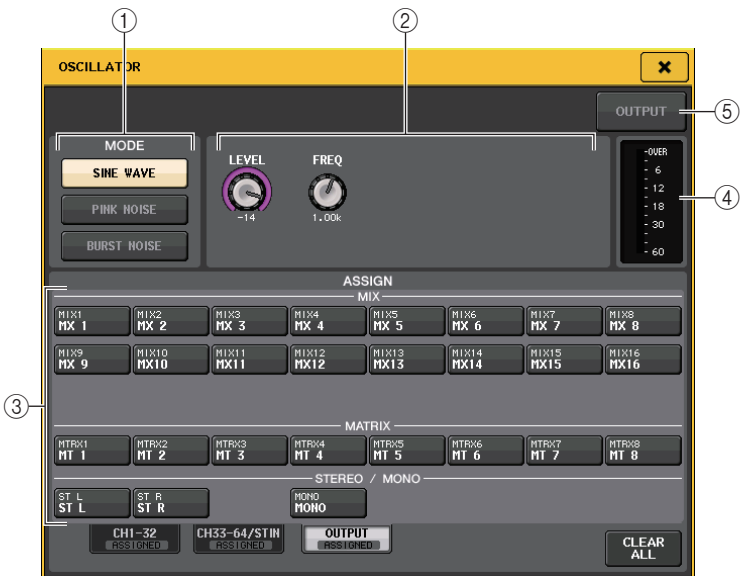

- ① **OSCILLATOR MODE buttons**  
Select one of the following three operating modes when the oscillator is turned on:

<b>SINE WAVE 1CH</b>	A sine wave will be output continuously.
<b>PINK NOISE</b>	Pink noise will be output continuously.
<b>BURST NOISE</b>	Pink noise will be output intermittently.

- ② **Parameter field**  
Enables you to set the oscillator parameters. The controllers and their functions in this field vary depending on the selected mode.

### Mode = SINE WAVE 1CH

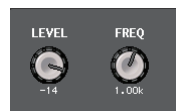

- **LEVEL knob** ..... Indicates the output level of the sine wave. You can use the [TOUCH AND TURN] knob to control the level.

- **FREQ knob** ..... Indicates the frequency of the sine wave. You can use the [TOUCH AND TURN] knob to adjust the value.

### Mode = PINK NOISE



- **LEVEL knob** ..... Indicates the output level of the pink noise. You can use the [TOUCH AND TURN] knob to control the level.
- **HPF knob** ..... Indicates the cutoff frequency of the HPF that processes pink noise. You can use the [TOUCH AND TURN] knob to adjust the value. Use the button below the knob to switch the HPF on or off.
- **LPF knob** ..... Indicates the cutoff frequency of the LPF that processes pink noise. You can use the [TOUCH AND TURN] knob to adjust the value. Use the button below the knob to switch the LPF on or off.

### Mode = BURST NOISE



- **LEVEL knob, HPF knob, and LPF knob** ..... Same as in PINK NOISE mode.
- **WIDTH** ..... Indicates the length of noise being output intermittently. You can use the [TOUCH AND TURN] knob to adjust the value.
- **INTERVAL** ..... Indicates the length of silence between noise bursts. You can use the [TOUCH AND TURN] knob to adjust the value.

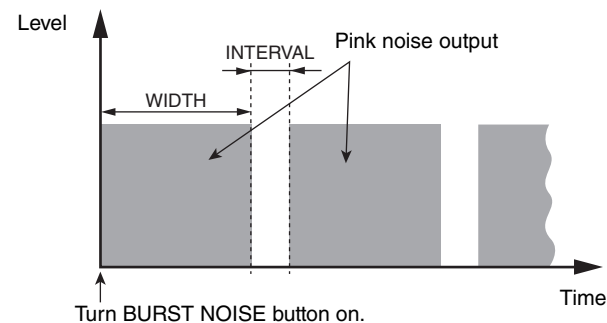



**③ ASSIGN section**

Enables you to select a channel to which the oscillator signal will be sent. Press one of the three tabs below to select the type of channels displayed, and then press the button(s) for the desired channel(s) (multiple selections are allowed). The "ASSIGNED" indicator is lit green for a tab that contains a selection.

You can press the CLEAR ALL button to defeat all selections.

**NOTE**

In the case of QL1, channels that do not exist on the model will not be shown.

**④ Meter section**

Indicates the oscillator output level.

**⑤ OSCILLATOR OUTPUT button**

Turns the oscillator output on or off. If you turn this button on, the oscillator signal will be sent to the input channel or bus you selected in the ASSIGN section. When you press the button again, the oscillator will turn off.

# Meters

This chapter explains the METER screen that shows the input and output level meters for all channels.

## Operations in the METER screen

By accessing the METER screen, you can view the input and output levels of all channels on the screen, and switch the level meter's metering points (the points in the signal route at which the level is detected). To access the METER screen, press the METER field of the Function Access Area.



## INPUT METER screen

This screen shows the meters and faders for all input channels.

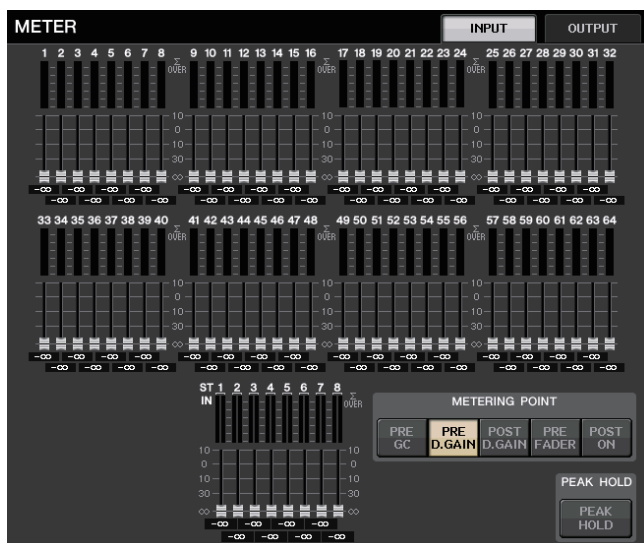

## NOTE

In the case of QL1, channels that do not exist on the model will not be shown.

## OUTPUT METER screen

This screen shows the meters and faders for all output channels.

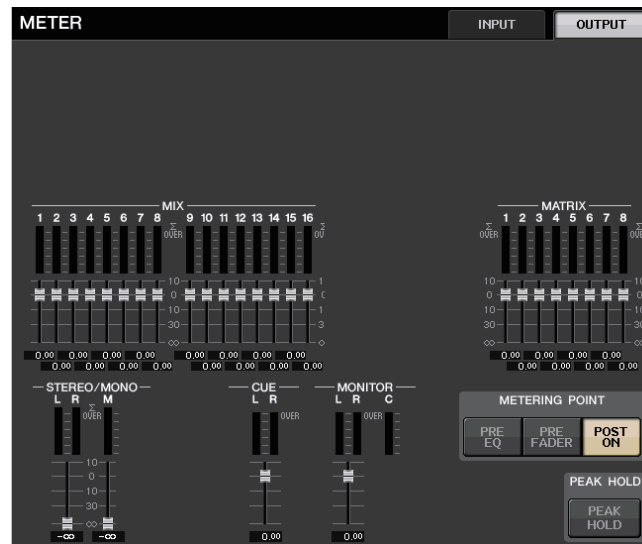

## INPUT/OUTPUT tabs

Use these tabs to switch between the INPUT METER screen and OUTPUT METER screen.



## Fader level and meter display

This area displays the meter and fader for each channel.

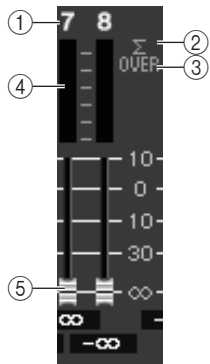

- ① **Channel number**  
Indicates the channel number.
- ② **Σ clipping indicator**  
Lights to indicate that a signal is clipping at some point in the channel.
- ③ **OVER indicator**  
Lights to indicate that a signal is clipping at the METERING POINT.
- ④ **Meter**  
Indicates the input or output level of the channel.
- ⑤ **Fader**  
The channel level is indicated by the fader position and by a numeric value (in dB) that appears immediately below the fader.

### NOTE

Press any part of the meter area to assign the corresponding fader bank to the Channel Strip section.

## METERING POINT field

Select one of the following as the metering point at which the level will be detected. The metering point for the level meter can be specified independently for input channels and output channels.

### ■ For INPUT METER

- **PRE GC** .....Immediately before GAIN COMPENSATION
- **PRE D. GAIN** .....Immediately before DIGITAL GAIN
- **POST D. GAIN** .....Immediately after DIGITAL GAIN
- **PRE FADER**.....Pre-fader (immediately before INPUT DELAY)
- **POST ON**.....immediately after the [ON] key



### ■ For OUTPUT METER

- **PRE EQ** .....Immediately before the EQ
- **PRE FADER**.....Immediately before the fader
- **POST ON**.....immediately after the [ON] key



## PEAK HOLD button

Turn on this button to hold the peak level indication on each meter. Turn off this button to clear the peak hold indication. PEAK HOLD button on/off operations will affect both input channels and output channels. When you turn this button off, the peak level indications that had been held will be cleared.



### NOTE

You can also assign the PEAK HOLD button on/off function to a USER DEFINED key ([page 169](#)).

# Graphic EQ, effects, and Premium Rack

This chapter explains how to use the built-in graphic EQ, effects, and Premium Rack.

## About the virtual rack

QL series consoles enable you to use the built-in graphic EQ (subsequently abbreviated as “GEQ”) and effects/processors to modify signals. You can use two types of GEQ: 31BandGEQ which enables you to freely adjust thirty-one bands (frequency regions), and Flex15GEQ which enables you to adjust any fifteen of thirty-one bands. You can use the 16ch Automixer or the 8ch Automixer. You can also use 54 different effect types. The QL series consoles feature Premium Rack, which employs VCM technology. This technology models analog circuitry on a component level to faithfully reproduce amazing analog sounds. The Premium Rack offers six types of processors.

In order to use a GEQ, effect, or Premium Rack, you must mount the GEQ, effect, or Premium Rack in each virtual rack, and patch the input and output of that rack to the desired signal route. In other words, the operation is just as though you had installed a signal processor or effect device in an actual rack, and used patch cords to connect it. You can mount a GEQ instance in each of the eight racks 1-8, an effect rack instance in each of the eight racks 1-8, and a Premium Rack instance in each of the eight racks 1-8.

Up to two channels of input and output can be used for each rack. (However if the “31BandGEQ” is mounted in a rack, there will be only one channel each for input and output.)

The figure below shows the signal flow for the virtual racks.

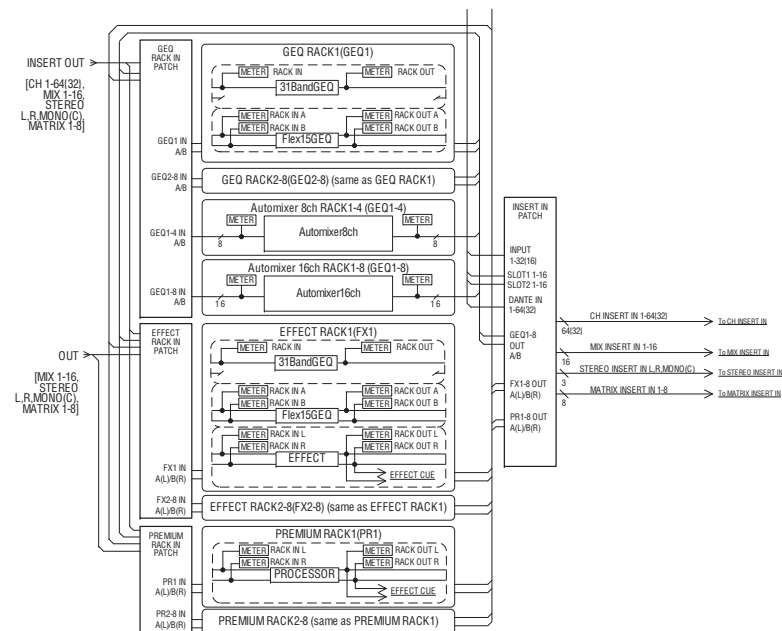

### NOTE

The QL console provides a rack for mounting an I/O rack (such as an Rio series), external head amps (Yamaha AD8HR, SB168-ES, etc.) as well as the virtual rack for GEQ, effects and Premium Rack. For details, refer to “I/O devices and external head amps” on page 127.

## Virtual rack operations

This section explains how to mount a GEQ or effect in the virtual rack, and patch the input and output of the rack as an example.

### STEP

1. In the Function Access Area, press the RACK button.
2. In the upper part of the VIRTUAL RACK window, press the GEQ or EFFECT tab.
3. To mount a GEQ or effect in the rack, press the rack mount button for that rack.
4. Use the buttons in the MODULE SELECT field in the RACK MOUNTER window to select the item you want to mount, and press the OK button.
5. Press the INPUT PATCH button.
6. In the CH SELECT window, select the input source and then press the OK button.
7. Press the OUTPUT PATCH button.
8. In the CH SELECT window, select the output destination and then press the OK button.

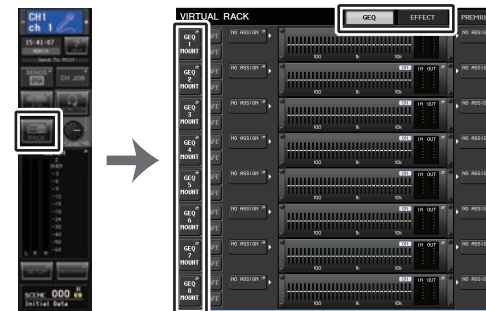

Function Access Area

VIRTUAL RACK window

### NOTE

- In steps 6 and 8, you can make settings such that the confirmation dialog box will not appear (page 168).
- The type of GEQ, effect, or Premium Rack mounted in each rack, its parameter settings, and the input-source and output-destination patch settings are saved as part of the scene.

## VIRTUAL RACK window

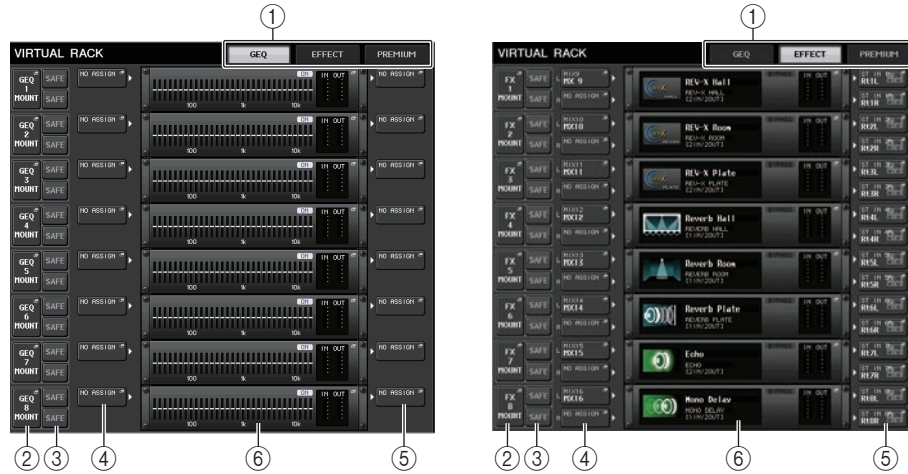

### ① Rack tabs

Selects the type of rack you want to display on the screen. Choose from GEQ (GEQ rack), EFFECT (effect rack), and PREMIUM (Premium Rack).

### ② Rack mount button

Press this button to open the RACK MOUNTER window, in which you can select the type of the rack you want to mount.



### ③ SAFE button

Switches Recall Safe on or off for the rack. If this button is turned on for a rack, the contents and parameters of that rack will not change when a scene is recalled. For more information on Recall Safe, refer to [“Using the Recall Safe function”](#) on page 61. The Recall Safe settings of each rack will not preserve the input/output patching to that rack. Recall Safe settings for patching must be made on the input-source or output-destination channel.

### ④ INPUT PATCH button

If the type is EFFECT, two buttons (L/R) will appear. If the type is Flex15GEQ or 8Band PEQ, two buttons (A/B) will appear. If the type is 31BandGEQ, one button will appear. Press this button to open the CH SELECT window, in which you can select the path of the signal patched to the rack input.

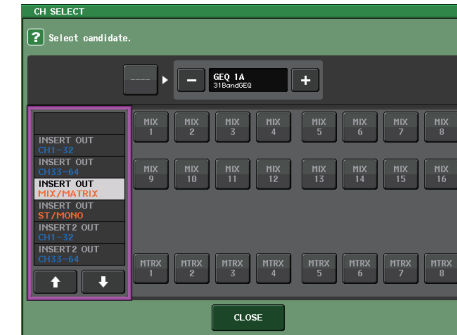

The categories and channels that can be selected are shown below.

- **MIX/MATRIX** .....MIX1-16, MATRIX1-8\*1
- **ST/MONO** .....STEREO L/R, MONO\*1
- **INSERT 1 OUT 1-32** .....CH1-32
- **INSERT 1 OUT 33-64** .....CH33-64 (QL5 only)
- **INSERT 1 OUT MIX/MATRIX** .....MIX1-16, MATRIX1-8
- **INSERT 1 OUT ST/MONO**.....STEREO L/R, MONO
- **INSERT 2 OUT 1-32** .....CH1-32
- **INSERT 2 OUT 33-64** .....CH33-64 (QL5 only)
- **INSERT 2 OUT MIX/MATRIX** .....MIX1-16, MATRIX1-8
- **INSERT 2 OUT ST/MONO**.....STEREO L/R, MONO

\*1. Not displayed for GEQ 1–8 RACK.

### NOTE

- In the case of QL1, channels that do not exist on the model will not be shown.
- In the case of the GEQ, patching it to either an insert-out or insert-in will automatically assign the other patch point to the same rack. Also, insert mode will automatically be switched on. Additionally, if you defeat the insert-out or insert-in of a GEQ, the other patch point will automatically be defeated and at the same time insert mode will automatically be switched off.
- In the case of the EFFECT, the operation is the same as that of the GEQ, if you select DYNAMICS & EQ as the EFFECT TYPE.
- In the case of the PREMIUM RACK, the operation is the same as that of the GEQ.
- For more information on insert-in/out, refer to [“Inserting an external device into a channel”](#) on page 18.

⑤ **OUTPUT PATCH button**

If the type is EFFECT, two buttons (L/R) will appear. If the type is Flex15GEQ or 8Band PEQ, two buttons (A/B) will appear. If the type is 31BandGEQ, one button will appear. Press this button to open the CH SELECT window, in which you can select the path of the signal patched to the rack output.



The categories and channels that can be selected are shown below.

- **CH1-32** .....CH1-32\*1, \*2
- **CH33-64** .....CH33-64\*1, \*2 (QL5 only)
- **ST IN** .....ST IN 1L-8R\*1, \*2
- **INSERT 1 IN 1-32** .....CH1-32
- **INSERT 1 IN 33-64** .....CH33-64 (QL5 only)
- **INSERT 1 IN MIX/MATRIX** .....MIX1-16, MATRIX1-8
- **INSERT 1 IN ST/MONO** .....STEREO L/R, MONO
- **INSERT 2 IN 1-32** .....CH1-32
- **INSERT 2 IN 33-64** .....CH33-64 (QL5 only)
- **INSERT 2 IN MIX/MATRIX** .....MIX1-16, MATRIX1-8
- **INSERT 2 IN ST/MONO** .....STEREO L/R, MONO

\*1. Not displayed for GEQ 1-8 RACK.

\*2. Not displayed for PREMIUM 3-8 RACK. Displayed only for PREMIUM 1-2 RACK.

**NOTE**

- In the case of QL1, channels that do not exist on the model will not be shown.
- If you use QL5 settings data on the QL1, buttons will be shown crossed-out if they are assigned to a channel that does not exist on that model.

⑥ **Rack container**

Indicates the contents of the rack. This container varies depending on the rack type you selected in the RACK MOUNTER window.

• **If nothing is mounted:**



Press this area to open the RACK MOUNTER window, in which you can select the GEQ or effect that will be mounted in the rack.

• **If 31BandGEQ is mounted:**

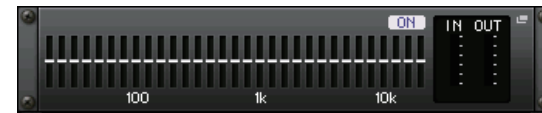

This area indicates the settings for each band, GEQ on/off status, and input/output level. Press this area to open the GEQ EDIT window, in which you can modify the GEQ settings.

• **If Flex15GEQ is mounted:**

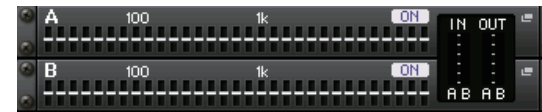

This area indicates the settings for each band, the GEQ on/off status, and the input and output levels for A and B respectively. Press this area to open the GEQ EDIT window, in which you can modify the GEQ settings for A and B.

• **If an effect is mounted (EFFECT rack only):**

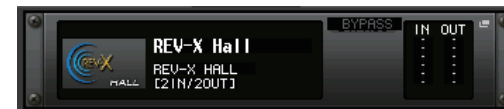

This area indicates the effect type, number of inputs and outputs, bypass on/off status, and the input/output level. Press this area to open the EFFECT EDIT window, in which you can modify the effect settings.

• **If Automixer is mounted (GEQ rack 1 only):**



Press this area to open the AUTOMIXER EDIT window, in which you can modify the automixer settings.

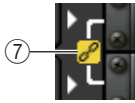

- ⑦ **Link indicator**  
Indicates that an odd-numbered rack and even-numbered rack of the 31BandGEQ, or A and B of the Flex15GEQ are linked each other.

## RACK MOUNTER window

Mount a GEQ or effect in the rack. This window will appear if you press the rack mount button in the VIRTUAL RACK window.

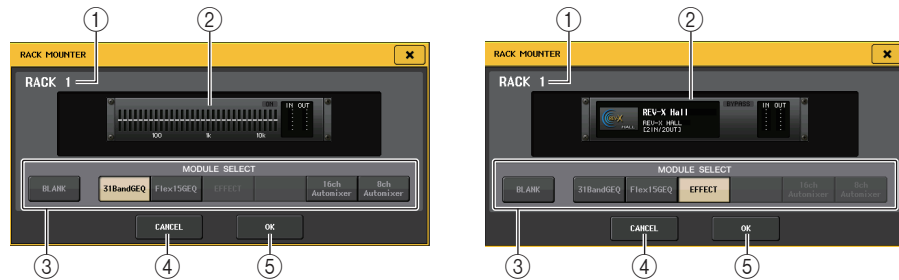

- ① **Rack number**  
Indicates the number for the selected rack.
- ② **Virtual rack**  
This area indicates the GEQ or effect selected via the MODULE SELECT buttons.
- ③ **MODULE SELECT field**  
Select the GEQ or effect that will be mounted in the rack. Each button has the following function.
  - **BLANK button**..... Removes the GEQ or effect currently mounted in the rack; the rack will be empty.
  - **31BandGEQ button** ..... Mounts a 31BandGEQ in the rack.
  - **Flex15GEQ button** ..... Mounts a Flex15GEQ in the rack.
  - **EFFECT button (EFFECT rack only)** .....Mounts an effect in the rack.
  - **16ch Automixer button (GEQ rack 1 only)**....Mounts a 16ch Automixer in the rack.
  - **8ch Automixer button (GEQ rack 1 only)** .....Mounts an 8ch Automixer in the rack.

### NOTE

- Input/output patching will be defeated if you change the item mounted in a rack.
- The 16ch Automixer is mounted in racks 1–8. The 8ch Automixer is mounted in racks 1–4.

- ④ **CANCEL button**  
Cancels the changes you made in the RACK MOUNTER window, and closes the window.

- ⑤ **OK button**  
Applies the changes you made in the RACK MOUNTER window, and closes the window.

### NOTE

Be aware that if you remove a GEQ or effect that was mounted in a rack and close the RACK MOUNTER window, all edits to the parameter settings for that GEQ or effect will be discarded. If you have not yet closed the window, you can recover the parameter settings by mounting the same GEQ or effect once again.

## Graphic EQ operations

The QL series console enables you to mount a GEQ in GEQ racks 1–8 and patch it to the insert-out/in of a MIX/MATRIX channel or STEREO/MONO channel. You can also mount it in EFFECT racks 1–8 (FX 1–8) and patch it to the insert-out/in of an input channel, MIX/MATRIX channel or STEREO/MONO channel. The gain of each band can be adjusted using the faders and [ON] keys in the Channel Strip section.

The following two types of GEQ are provided.

### ■ 31BandGEQ

This is a monaural 31-band GEQ. Each band is 1/3 octave wide, the adjustable gain range is  $\pm 15$  dB, and the gain of all thirty-one bands can be adjusted.

If a 31BandGEQ is mounted in a rack, one channel of input and output can be used for that rack.

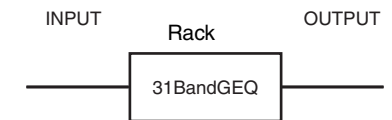

### ■ Flex15GEQ

This is a monaural 15-band GEQ. Each band is 1/3 octave wide, and the adjustable gain range is  $\pm 15$  dB. The Flex15GEQ enables you to adjust the gain for any fifteen of the same bands as the thirty-one bands of the 31bandGEQ. (Once you have used up fifteen bands of adjustment, you will not be able to adjust the gain of another band until you reset a previously-adjusted band to the flat setting.)

A rack for which the Flex15GEQ is selected will have two Flex15GEQ units (shown as “A” and “B” respectively) mounted in that rack, and will allow two channels of input and output. If you mount a Flex15GEQ in each rack, you will be able to use up to 32 GEQ units simultaneously.

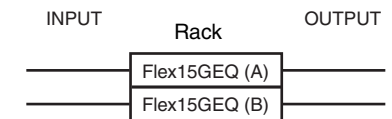



## Inserting a GEQ in a channel

This section explains how to insert a GEQ into the selected channel for use.

### STEP

1. Refer to steps 1–8 in “[Virtual rack operations](#)” on [page 103](#) to mount a GEQ in a rack and set its input source and output destination.
2. In the GEQ field rack or the EFFECT field rack, press the rack container in which you mounted the GEQ.
3. If you’re using a stereo source, press the GEQ LINK button to link the two GEQ units.
4. Press the GEQ ON/OFF button to turn the GEQ on.

### NOTE

- If you are using a stereo source, you can mount a Flex15GEQ, or mount two 31BandGEQ units in adjacent odd-numbered/even-numbered racks. This will let you link the two GEQ units in a later step.
- You can view the input and output levels of the GEQ in the rack in the GEQ field.
- For details on GEQ operations, refer to the following section “[Using the 31BandGEQ](#)” or “[Using the Flex15GEQ](#)” on [page 108](#).

## GEQ EDIT window

### NOTE

- The windows for the 31BandGEQ and the Flex15GEQ are nearly identical. However, the Flex15GEQ individually displays two GEQ units (A and B) mounted in a single rack.
- Pressing a top panel [SEL] key while operating the GEQ will switch to the popup window of GEQ, effect, or premium rack that is inserted in that channel.

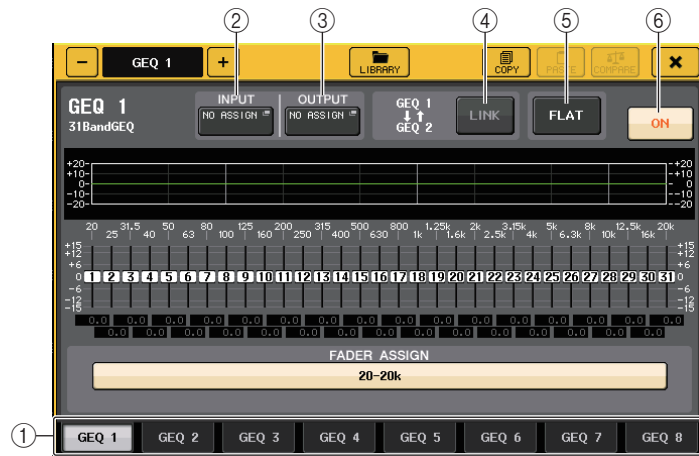

#### ① Rack select tabs

Switch among GEQ 1–8, or among EFFECT 1–8. For a rack in which a Flex15GEQ is mounted, the tabs will be split as xA and xB (x is the rack number).

#### ② INPUT button

Press this button to open the CH SELECT window, in which you can select the input source of the rack. The operating procedure is the same as for the INPUT button in the GEQ field.

#### ③ OUTPUT button

Press this button to open the CH SELECT window, in which you can select the output destination of the rack. The operating procedure is the same as for the OUTPUT button in the GEQ field.

#### ④ GEQ LINK button

Press this button to open the GEQ LINK window, in which you can link adjacent GEQ units.

In the case of a 31bandGEQ, the GEQ units in adjacent odd-numbered/even-numbered racks will be linked. In the case of a Flex15GEQ, the GEQ (A) and GEQ (B) within the same rack will be linked.



- **GEQ x→y button (“x” and “y” are the rack number, or the rack number and alphabetical character A or B)**  
The parameters of “x” will be copied to “y,” and then linked.
- **GEQ y→x button**  
The parameters of “y” will be copied to “x,” and then linked.
- **RESET BOTH button**  
The parameters of both will be initialized, and then linked.
- **CANCEL button**  
Cancels the link and closes the window.

### NOTE

The GEQ LINK button is shown only if linking is possible. When you link GEQ units, a symbol will appear in the GEQ field to indicate the linked status.



#### ⑤ FLAT button

Returns all bands of the currently-selected GEQ to 0 dB.

#### ⑥ GEQ ON/OFF button

Switches the currently-selected GEQ on or off.

## Using the 31BandGEQ

You will use the Channel Strip section's faders 1–8 and [ON] keys to control the 31BandGEQ.

### STEP

1. In the GEQ field or the EFFECT field rack, press the rack container in which you mounted the 31BandGEQ.
2. Press the GEQ ON/OFF button to turn the 31BandGEQ on.
3. Press one of the buttons in the FADER ASSIGN field to select the group of bands you will control.
4. Use the faders in the Channel Strip section to adjust the selected band.
5. When you've finished making settings, turn off the buttons in the FADER ASSIGN field.

### NOTE

- When a fader in the Channel Strip section is set to the center (flat) position, the corresponding [ON] key indicator will turn off. This indicates that the corresponding band is not being modified. If you raise or lower the fader even the slightest amount, the [ON] key will light, indicating that this band has been modified. If you press a lit [ON] key to make it go dark, the corresponding band will immediately return to the flat state. If you press the [ON] key once again, the value that was modified is shown.
- If you switch the display to a different screen or rack, the fader assignments in the Channel Strip section will forcibly be defeated. However if you once again display the same rack, the group of bands you had previously been controlling will automatically be assigned to the faders.
- When you close the GEQ window, the buttons in the FADER ASSIGN field automatically turn off.

## GEQ EDIT window (31BandGEQ)

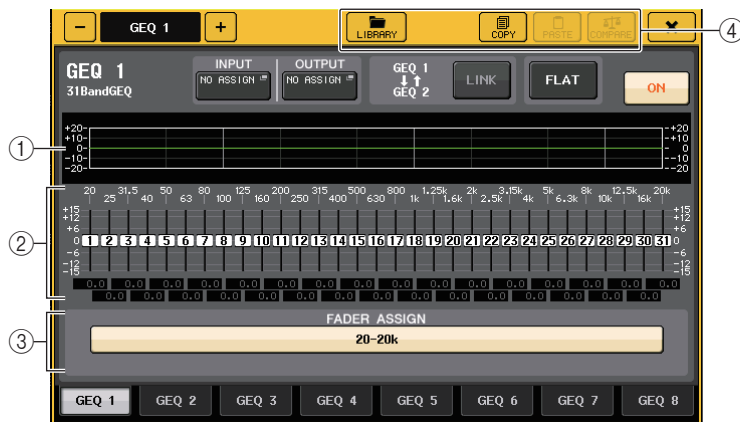

### ① EQ graph

Indicates the approximate response of the current 31BandGEQ.

### ② Faders

Indicate the amount of boost and cut for each band of the 31BandGEQ. The actual values are shown in the numerical boxes below.

### ③ FADER ASSIGN field

Use the faders in the Channel Strip section to select the group of bands that will be controlled. The buttons in the FADER ASSIGN field correspond to the following groups of bands (QL1 only).

20-630	16 bands 20 Hz–630 Hz
125-4k	16 bands 125 Hz–4 kHz
630-20k	16 bands 630 Hz–20 kHz

When you press one of these buttons, the faders for the bands selected on screen will turn white, and the numbers of the corresponding faders in the Channel Strip section will be displayed. Now you can use the faders in the Channel Strip section to control the band.

### ④ Tool buttons

Copy the currently-displayed 31BandGEQ settings to the GEQ of another rack, or initialize the settings. For details on how to use the tool buttons, refer to “Using the tool buttons” in the separate Owner’s Manual.

### NOTE

- Only 31BandGEQ settings that use fifteen bands or less can be copied to a Flex15GEQ.
- GEQ settings can be stored and recalled at any time using the dedicated library.

## Using the Flex15GEQ

You will use the Channel Strip section's faders and [ON] keys to control the Flex15GEQ.

A rack in which a Flex15GEQ is mounted will show information for two GEQ units (A and B) in the VIRTUAL RACK window.

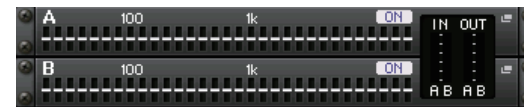

### NOTE

If you mount a Flex15GEQ, two monaural 31BandGEQ units will be placed in a single rack. However, only up to fifteen bands can be adjusted for each unit.

**STEP**

1. Press the rack container in which you mounted Flex15GEQ.
2. Press the GEQ ON/OFF button to turn the Flex15GEQ on.
3. Press one of the buttons in the FADER ASSIGN field to select the group of bands you will control.
4. Use the faders in the Channel Strip section to adjust the selected band.
5. When you've finished making settings, turn off the buttons in the FADER ASSIGN field.

**NOTE**

- When a fader in the Channel Strip section is set to the center (flat) position, the corresponding [ON] key indicator will turn off. This indicates that the corresponding band is not being modified. If you raise or lower the fader even the slightest amount, the [ON] key will light, indicating that this band has been modified.
- If you press a lit [ON] key to make it go dark, the corresponding band will immediately return to the flat state. If you press the [ON] key once again, the value that was modified is shown.
- If you switch the display to a different screen, the fader assignments in the Channel Strip section will forcibly be defeated. However if you once again display the same rack, the group of bands you had previously been controlling will automatically be assigned to the faders.
- When you close the GEQ window, the buttons in the FADER ASSIGN field automatically turn off.

**GEQ EDIT window (15BandGEQ)**

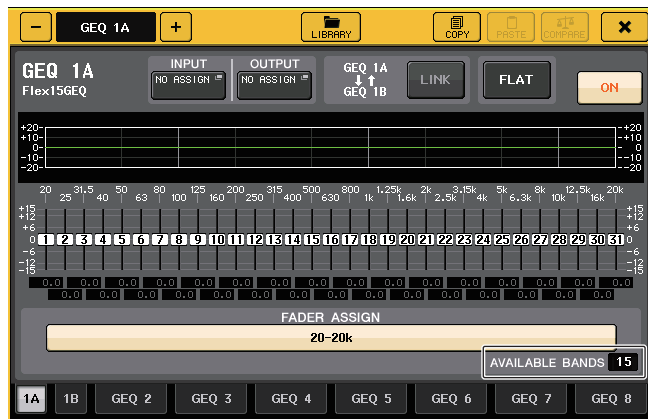

This window is the same as that for the 31BandGEQ, except that the AVAILABLE BANDS parameter box indicates the real-time number of additional bands (maximum 15) that can be controlled in the current GEQ.

For a rack in which a Flex15GEQ is mounted, the rack switch tabs will be split as xA and xB (x is the rack number).

**About AUTOMIXER**

Automixer is included as a standard feature on the QL series. Automixer searches for enabled mics and automatically optimizes gain distribution, for uses such as speeches without scripts. This allows uniform system gain to be maintained among multiple mics, freeing the engineer from making constant fader adjustments.

**Automixer operating principle**

With the Dugan speech system used in Automixer, you can automatically adjust the gain for multiple mics used for speeches.

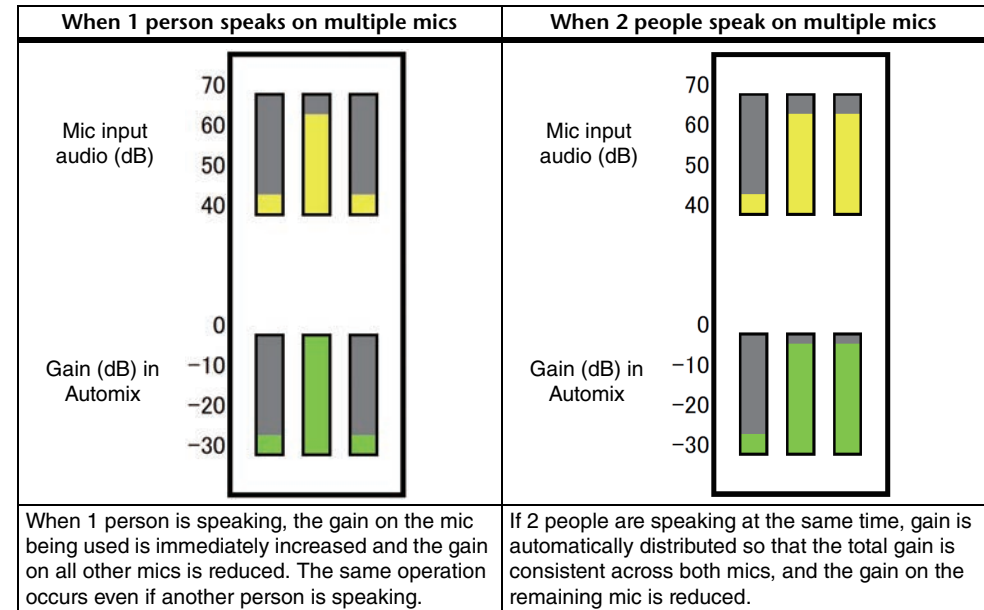

The Dugan speech system functions differently from a limiter or auto level controller. When multiple people are speaking, the engineer mixes the gain for each mic using the faders conventionally. Even if nobody is speaking, the system searches for mic audio and automatically distributes gain. Therefore, faders can leave in their raised positions.

## Inserting Automixer in channels post-fader

This section explains how to mount Automixer in a virtual rack, and insert Automixer input and output into channels (excluding ST IN channels) post-fader (POST ON). For details on Automixer operations, refer to the following section “Using Automixer.”

### STEP

1. Refer to steps 1–8 in “Virtual rack operations” on page 103 to mount Automixer in rack 1 and set its input source and output destination.
2. Refer to “Inserting an external device into a channel” on page 18 to insert Automixer in post-fader (POST ON field).

## Using Automixer



### Channel display

The auto mix gain meter for each channel and man (yellow), auto (green), and mute (red) settings are shown for channels 1–8 and channels 9–16.

If you select the channel 1–8 or 9–16 region, the display channel for the channel control field will switch to 1–8 or 9–16.

(For 8ch Automixer, only channels 1–8 are shown.)

## Channel control field

Each channel is always in man, auto, or mute mode. The indicator for the enabled channel mode will light. To select a mode, either press the button for that mode or press the PRESET button in the master field.

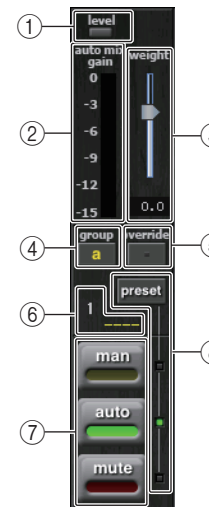

### 1 Level indicator

Lights green when the audio is at an optimum level for Automix.

### NOTE

- If the level indicator flashes, increase the input gain.
- If the level indicator lights up red, reduce the input gain.

### 2 Meter indicator

There are three display modes. Pressing the meters button in the master field will switch modes.

gain	Displays the gain for Automixer.	Green
input	Displays the input level.	Yellow
output	Displays the output level.	Blue

### NOTE

Meters should normally be set in gain mode.

### 3 weight

Adjusts the correlative sensitivity between input channels. When there is no input, adjust the weight setting so that all auto mix gain meters are at about the same level. Use the [TOUCH AND TURN] knob to change the channel weight settings by adjusting the weight slider.

Automixer calculates the ratio of input level for specific channels for all input mixes in the group. The following example explains the weight control mechanism.

#### ■ When increasing the weight setting in one channel

- the value displayed in the auto mix gain meter for that channel increases, while the values for other channels are reduced.
- Channels with high weight setting values receive a higher system gain than other channels.

#### ■ When reducing the weight setting in one channel

- the value displayed in the auto mix gain meter for that channel reduces, while the values for other channels are increased.
- When speaking into multiple mics at the same time, it is difficult to distinguish between different mics.

If you can hear noise near one mic (example: noise from a computer ventilation fan or an air conditioner), you can suppress the noise by reducing the weight setting for that channel.

#### ④ group

Each channel can be assigned to three groups (a/b/c).

This group function is convenient for the following uses.

- Using multiple rooms: Assign the mics in each room to their own groups, and use a different Automixer for each.
- Stereo pan: Assign mics panned to left, right and center to groups a, b, and c, to maintain a stable stereo field.

#### ⑤ override

If you turn on the OVERRIDE button in the master field, the channel will switch to man mode or mute mode according to the settings for that channel's override button.

- When the channel's override button is on, the mode for that channel will switch to man when the master OVERRIDE button is turned on.
- When the channel's override is off, the mode for that channel will switch to mute when the master OVERRIDE button is turned on.
- When the master OVERRIDE button is turned off, the channel will return to its previous mode.

The override function is convenient when the moderator of a panel discussion wants to control the system.

Follow the instructions below to change the settings.

1. Turn on the override button on the moderator's channel.
2. Turn off the override button on all other channels.
3. Turn on the OVERRIDE button in the master field as needed.

#### ⑥ Channel number

Displays the channel number and channel name of the channel to be inserted.

#### ⑦ man/auto/mute

Toggles between man/auto/mute.

man: Passes the audio through without changing the gain. This mode is used for singing with a mic.

auto: Turns on Automixer. This mode is used for conversations.

mute: Mutes channels.

#### ⑧ preset

Selects the channel mode (man/auto/mute) when the PRESET button in the master field is pressed. The preset button lights when a preset is programmed for a channel.

#### ■ Master field

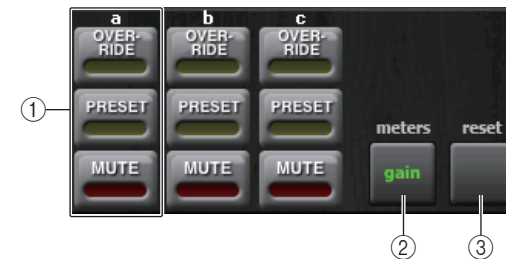

#### ① OVERRIDE/PRESET/MUTE

Makes settings for each group (a/b/c) selected in the channel control field. Shows only the selected group.

##### • OVERRIDE

When you press this button, channels where the channel override button is on will fade in to 0 dB (unity gain). All channels with the override button turned off will be muted.

##### • PRESET

When you press this button, each channel will switch to the mode indicated by the mode button (man/auto/mute) next to the lit preset indicator. When the power is turned on, each channel will be set to its preset mode.

##### • MUTE

When you press this button, all channels will fade out immediately (0.5 seconds).

When you press this button, channels where the channel override button is on will fade in to 0 dB (unity gain). All channels with the override button turned off will be muted.

#### ② meters

Switches the meter indicator in the channel control field. Toggles between gain, input, and output each time you press the button.

#### NOTE

Meters should normally be set in gain mode.

#### ③ reset

Initializes the Automixer settings.

## Editing the internal effects

The internal effects of the QL series console can be mounted in EFFECT racks 1–8, and patched to an output channel's output or input channel's input, or inserted into a channel. For each effect mounted in a rack, you can choose one of 54 types of effect.

With the default settings, the signals from MIX channels 13–16 are input to racks 5–8, and from the racks are then output to ST IN 1–4 (L/R). There are no assignments to racks 1–4.

### NOTE

Some effect types can be mounted only in racks 1, 3, 5 or 7.

To use an internal effect via send and return, assign the output of a MIX channel to the input of the effect, and assign the output of the effect to an input channel. In this case, the corresponding output channel is used as a master channel for the effect send, and the input channel is used as an effect return channel.

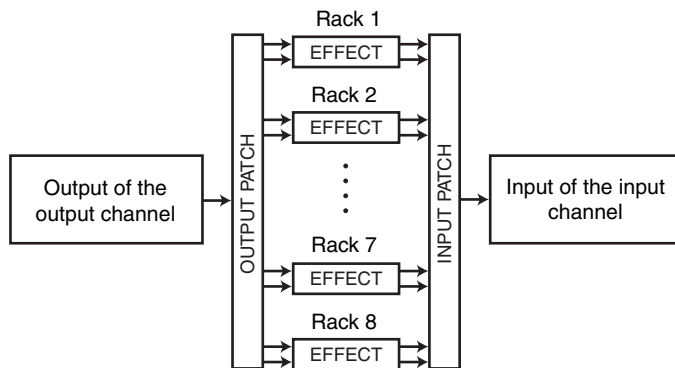

Alternatively, you can assign the input and output of the internal effect to the insert-out/in of a desired channel (except for a ST IN channel), so that the effect is inserted into that channel.



\* Excluding a ST IN channel

The internal effects fall into two categories; “STEREO type” (2-in/2-out) effects that process the L/R channel input signals independently, and “MIX type” (1-in/2-out) effects that mix the two channels before processing them.

If signals are assigned to both the L and R inputs of an effect, the way in which the L/R channels are processed will depend on whether a Stereo effect type or a Mix effect type is selected, as follows.

### STEREO type effects



### MIX type effects



If a signal is assigned to only one input of a two-input effect, it will be processed as mono-in/ stereo-out regardless of whether a Stereo effect type or Mix effect type is selected. However, please note that this will not apply to COMP276, COMP276S, COMP260, COMP260S, EQUALIZER601, and OPENDECK.



## Using an internal effect via send and return

This section explains how to use a MIX bus as an effect send bus and a ST IN channel as an effect return channel, so that the effect can be used in a send and return configuration.

### NOTE

- If you want to use a MIX bus as an effect send bus, select “VARI” as the bus type. This will allow you to adjust the send level separately for each input channel.
- If you want to use the input to an effect in stereo, it is convenient to assign the send-destination MIX bus to stereo. (For details on bus assignments, refer to “Basic settings for MIX buses and MATRIX buses” on page 189.)

### STEP

1. Follow steps 1–3 described in “Virtual rack operations” on page 103, to mount an effect in a rack.
2. Press the INPUT PATCH L button in the VIRTUAL RACK window, and select a MIX channel as the input source for the rack (page 103).
3. Press the OUTPUT PATCH L button in the VIRTUAL RACK window, and select the L input of a ST IN channel as the output destination for the rack (page 103).
4. Adjust the send level from each channel in the SEND field in the SELECTED CHANNEL VIEW screen.
5. Adjust the master level of the effect send of the MIX channel you selected as the input source for the rack.
6. Adjust the effect return level of the ST IN channel you selected as the output destination for the rack.



**NOTE**

- If you're using a stereo source, assign the L/R signals of the stereo MIX channels to the L/R inputs of the rack.
- If you're using the output of the effect in stereo, assign the R input of the ST IN channel selected in step 3 to the R output of the rack.
- You can select more than one output destination for the effect.
- For more information on setting the effect parameters, refer to “[Editing the internal effect parameters](#)” on [page 114](#).

**■ Adjusting the effect send level of an input channel**

In the SEND field in the SELECTED CHANNEL VIEW screen, press and select the TO MIX SEND LEVEL knob for the MIX bus set as the input source for the rack, and use the [TOUCH AND TURN] knob to adjust the send level of the signal sent from each channel to that MIX bus.

**NOTE**

- When adjusting the effect send level, make sure that the send level from the ST IN channel you selected as the output destination for the rack to the corresponding MIX bus is set to  $-\infty$  dB. If you raise this send level, the output of the effect will be returned to the input of the same effect, possibly causing oscillation.
- If you press the knob once again, the MIX SEND window (8ch) for the send-destination MIX bus will appear. This window contains on/off switches for the signals sent from each channel to the corresponding bus, and lets you select the send point (PRE or POST) ([page 35](#)).

**■ Adjusting the master level of the effect send**

Operate the fader for the MIX channel you specified as the input source for the rack. Set the level as high as possible without allowing the post-effect signal to reach the overload point.

**NOTE**

The input and output levels of the effect are shown by the input/output meters in the upper right of the EFFECT EDIT window.

**■ Adjusting the effect return level**

To adjust the effect return level, operate the fader for the ST IN channel you specified as the output destination for the rack.

**Inserting an internal effect into a channel**

This section explains how to insert an effect into a channel by assigning the input/output of the internal effect to the input/output of the desired channel (except for a ST IN channel). For details on editing the effect parameters, refer to “[Editing the internal effect parameters](#)” on [page 114](#).

**STEP**

1. Follow steps 1–3 described in “[Virtual rack operations](#)” on [page 103](#), to mount an effect in a rack.
2. Press the INPUT PATCH L button in the VIRTUAL RACK window, and select the insert-out for one of the channels as the input source for the rack ([page 103](#)).
3. Press the OUTPUT PATCH L button in the VIRTUAL RACK window, and select the insert-1in or insert-2in of the same channel as the output destination for the rack ([page 103](#)).
4. Use the Bank Select keys and the [SEL] key to select the channel into which you inserted the effect.
5. Press the popup button in the INSERT field in the SELECTED CHANNEL VIEW screen.
6. In the INSERT/DIRECT OUT popup window, turn on the INSERT ON/OFF button for the channel into which you inserted the effect.
7. Display the EFFECT EDIT window again, and select the effect type and edit the effect parameters.
8. Using the fader of the channel you selected as the rack's output destination in step 3, adjust the level as appropriate.

**NOTE**

- If you are inserting an effect into a channel that handles a stereo source, assign the R channel insert-out/insert-in to the R input and output of the effect in the same way as step 3.
- For more information about how to operate the INSERT/DIRECT OUT window, refer to “[Inserting an external device into a channel](#)” on [page 18](#).
- The levels before and after the effect are shown by the input and output meters in the upper right of the EFFECT EDIT window.
- Adjust the effect send master level and the effect parameters so that the signal does not reach the overload point at the input or output stage of the effect.



## Editing the internal effect parameters

This section explains how to change the effect type and edit the parameters. For a rack in which an effect is mounted, the following information is shown in the VIRTUAL RACK window.



### ① Effect title/type

Displays the effect title, the name of the type that is used, and a graphic. The number of input and output channels (1 IN/2 OUT or 2 IN/2 OUT) of this effect is also shown.

### ② Input/output meters

Indicate the level of the signals before and after the effect.

## STEP

1. Press the rack container in which the effect you want to edit is mounted.
2. To change the effect type, press the effect type field in the EFFECT EDIT window, and select the effect type in the EFFECT TYPE window.
3. Press a knob in the effect parameter field in the EFFECT EDIT window to select it, and turn the [TOUCH AND TURN] knob to edit the effect parameters.
4. Edit the settings in the special parameter field as necessary.

## EFFECT EDIT window

Allows you to adjust the effect parameters.

### NOTE

- For details on the parameters of each effect type, refer to the QL Data List (End of Manual).
- Pressing a top panel [SEL] key while operating the effect parameter will switch to the popup window of GEQ, effect, or premium rack that is inserted in that channel.



### ① INPUT L/R buttons

### ② OUTPUT L/R buttons

Press this button to open the CH SELECT window.

### ③ Effect type field

Displays the effect title, the name of the type that is used, and a graphic. The number of input and output channels (1 IN/2 OUT or 2 IN/2 OUT) of this effect is also shown. Press this field to open the EFFECT TYPE window, in which you can select the effect type.



**NOTE**

- You can also change the effect type by recalling a library setting.
- Effect types "HQ.PITCH" and "FREEZE" can be used only in rack 1, 3, 5, or 7. Also, even if you copy these two effect types, you will not be able to paste them to rack 2, 4, 6, or 8.

④ **EFFECT CUE button**

Cue-monitors the output of the currently-displayed effect. This Cue function is valid only while this screen is displayed. The cue will be canceled automatically when you switch to a different screen.

**NOTE**

If the Cue mode is set to MIX CUE, all channels for which the CUE key is turned on will be monitored. However, only the output signal of the effect will be monitored if you turn on the EFFECT CUE button. (The [CUE] keys that had been turned on until then will be temporarily defeated.)

⑤ **Special parameter field**

Indicates special parameters that are specific to some effect types.

**TEMPO**

This field appears if a tempo-type or modulation-type effect is selected.

• **MIDI CLK button**

If you turn this button on, the BPM parameter of that effect will be set to match the tempo of the MIDI timing clock being input from the MIDI port.



**PLAY/REC**

This field appears if FREEZE is selected as the effect type.

• **PLAY button/REC button**

Enable you to record (sample) and play back when using the freeze effect. For detailed operations, refer to "Using the Freeze effect" on page 118.



**SOLO**

This field appears if M.BAND DYNA. or M.BAND COMP. is selected as the effect type.

• **HIGH/MID/LOW buttons**

Allow only the selected frequency band to pass (multiple selections are allowed).

• **Gain reduction meters**

Indicate the amount of gain reduction for each band.



**Gain reduction meter**

This field appears if Comp276/276S or Comp260/260S is selected as the effect type.

• **Gain reduction meters**

Indicate the amount of gain reduction applied by the compressor.



**Type**

This field is displayed when Equalizer601 is selected as the effect type.

• **DRIVE button/CLEAN button**

Select one of two equalizer types that feature different effects.

DRIVE emulates changes in frequency response of analog circuits, creating a driven sound that enhances analog characteristics by adding some distortion.

CLEAN emulates changes in frequency response that are typical of analog circuits, creating a clear non-distorted sound that is inherently digital.

• **FLAT button**

This button resets the gain of all bands to 0dB.



⑥ **BYPASS button**

Temporarily bypasses the effect.

⑦ **Input/output meters**

Indicate the level of the signals before and after the effect.

⑧ **Effect parameter field**

This area indicates parameters for the currently-selected effect type. When you press a knob in this field, you will be able to use the [TOUCH AND TURN] knob to control the corresponding horizontal row of knobs.

You can also make fine adjustments by rotating the knob while pressing and holding it down.

⑨ **MIX BAL. knob**

Adjusts the balance between the original sound and effect sound included in the output signal from the effect. If you press this knob to select it, you will be able to adjust it using the [TOUCH AND TURN] knob. If you are using the effect via send and return, set this to 100% (effect sound only).

⑩ **Tool buttons**

Copy the currently-displayed effect settings to the effect of another rack, or initialize the settings. For details on how to use the tool buttons, refer to “Using the tool buttons” in the separate Owner’s Manual.

**NOTE**

Effect settings can be stored and recalled at any time using the effect library.

⑪ **Rack select tabs**

Enable you to switch between EFFECT 1–8.

## Using the Tap Tempo function

“Tap tempo” is a function that lets you specify the delay time of a delay effect or the modulation speed of a modulation effect by striking a key at the desired interval. The Tap Tempo function can be used for delay-type and modulation-type effects in which the BPM parameter is included, and specify the delay time or modulation speed. To use the Tap function, you must assign Tap Tempo to a USER DEFINED key, and then operate that USER DEFINED key.

**NOTE**

For details on the parameters of each effect type, refer to the QL Data List (End of Manual).

### ■ Assigning the Tap Tempo function to a USER DEFINED key

**STEP**

1. In the Function Access Area, press the **SETUP** button.
2. Press the **USER SETUP** button in the upper left of the **SETUP** screen.
3. Press the **USER DEFINED KEYS** tab in the **USER SETUP** window.
4. On the **USER DEFINED KEYS** page, press the button for the **USER DEFINED** key to which you want to assign the Tap Tempo function.
5. Select “**TAP TEMPO**” in the **FUNCTION** column, select “**CURRENT PAGE**” in the **PARAMETER 1** column in the **USER DEFINED KEY SETUP** window, and press the **OK** button.



SETUP screen

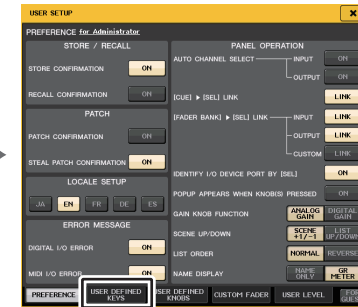

USER SETUP window

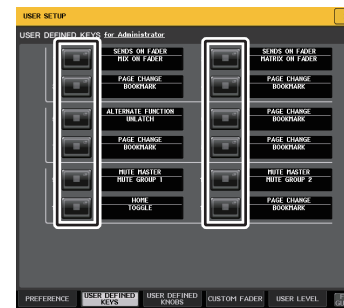

USER DEFINED KEYS page



USER DEFINED KEY SETUP window

**NOTE**

- If you specify “CURRENT PAGE” in the PARAMETER 1 column in the USER DEFINED KEY SETUP window, the Tap Tempo function can be used for the currently-displayed effect (rack).
- If you specify “RACK x” (x=1–8) in the PARAMETER 1 column in the USER DEFINED KEY SETUP window, you can use the Tap Tempo function only for a specific effect (rack).
- For more information on USER DEFINED keys, refer to “USER DEFINED keys” on page 169.

## Using the Tap Tempo function

The average interval (BPM) at which you press the USER DEFINED key will be calculated, and that value will be applied to the BPM parameter.

The average interval will be input to the parameter.  
(the average of a, b, and c)

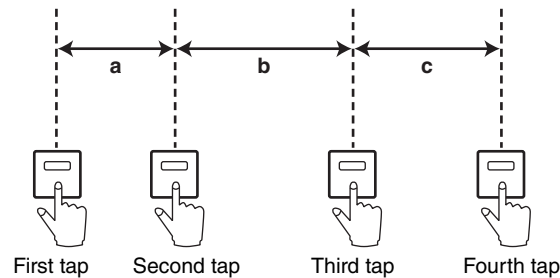

### NOTE

- If the average value is outside the range of 20–300 BPM, it will be ignored.
- If you turn on the MIDI CLK button in the special parameter field, the BPM parameter value will change in relation to the tempo of the MIDI timing clock received from the MIDI port.

### STEP

1. In the Function Access Area, press the RACK button.
2. Press the EFFECT tab in the VIRTUAL RACK window.
3. Press the rack container in which the effect you want to control is mounted.
4. Press the effect type field in the EFFECT EDIT window.
5. In the EFFECT TYPE window, select an effect type that includes a BPM parameter.
6. Set the SYNC parameter ON in the effect parameter field.
7. At the desired tempo, repeatedly press the USER DEFINED key to which you assigned the Tap Tempo function, to set the BPM parameter.



Tap Tempo window

## Effects and tempo synchronization

Some effects of the QL series can be synchronized with the tempo. There are two such types of effect; delay-type effects and modulation-type effects. For delay-type effects, the delay time will change according to the tempo. For modulation-type effects, the frequency of the modulation signal will change according to the tempo.

### Parameters related to tempo synchronization

The following five parameters are related to tempo synchronization.

- 1) SYNC
- 2) NOTE
- 3) TEMPO
- 4) DELAY
- 5) FREQ.

SYNC: ..... This is the on/off switch for tempo synchronization.

NOTE and TEMPO: .... These are the basic parameters for tempo synchronization.

DELAY and FREQ.: ..... DELAY is the delay time, and FREQ. is the frequency of the modulation signal. These directly affect the way in which the effect sound will change. DELAY is relevant only for delay-type effects, and FREQ. is relevant only for modulation-type effects.

### How the parameters are related

Tempo synchronization calculates the DELAY (or FREQ.) value<sup>a</sup> from the TEMPO and NOTE.

Turn SYNC ON

Change NOTE → DELAY (or FREQ.) will be set

In this case, the DELAY (or FREQ.) value is calculated as follows.

$$\text{DELAY (or FREQ.)} = \text{NOTE} \times 4 \times (60/\text{TEMPO})$$

Change TEMPO → DELAY (or FREQ.) will be set

In this case, the DELAY (or FREQ.) value is calculated as follows.

$$\text{DELAY} = \text{NOTE} \times 4 \times (60/\text{TEMPO}) \text{ sec}$$

$$\text{FREQ.} = (\text{TEMPO}/60) / (\text{NOTE} \times 4) \text{ Hz}$$

### Example 1:

When SYNC=ON, DELAY=250 ms, TEMPO=120, you change NOTE from 8th note to quarter note

$$\text{DELAY} = \text{new NOTE} \times 4 \times (60/\text{TEMPO})$$

$$= (1/4) \times 4 \times (60/120)$$

$$= 0.5 \text{ (sec)}$$

$$= 500 \text{ ms}$$

Thus, the DELAY will change from 250 ms to 500 ms.

**Example 2:**

When SYNC=ON, DELAY=250 ms, NOTE=8th note, you change TEMPO from 120 to 121

$$\begin{aligned} \text{DELAY} &= \text{NOTE} \times 4 \times (60/\text{new TEMPO}) \\ &= (1/8) \times 4 \times (60/121) \\ &= 0.2479 \text{ (sec)} \\ &= 247.9 \text{ (ms)} \end{aligned}$$

Thus, the TEMPO will change from 250 ms to 247.9 ms.

\*a Rounded values are used for the calculation results.

**Special characteristics of the TEMPO parameter**

The TEMPO parameter has the following characteristics that are unlike other parameters.

- It is a common value shared by all effects. (However, this is relevant only if you turn the MIDI button and the SYNC parameter on, while a MIDI CLOCK is being input to the MIDI IN connector.)
- You cannot store it to or recall it from the Effects Library. (You can store it to and recall it from a Scene.)

This means that the TEMPO value may not necessarily be the same when an effect is recalled as when that effect was stored. Here is an example.

Store the effect: TEMPO=120 → Change TEMPO to 60 → Recall the effect: TEMPO=60

Normally when you change the TEMPO, the DELAY (or FREQ.) will be re-set accordingly. However if the DELAY (or FREQ.) were changed, the effect would sound differently when recalled than when it was stored. To prevent the effect from changing in this way between store and recall, the QL series does not update the DELAY (or FREQ.) value when an effect is recalled, even if the TEMPO is no longer the same as when that effect was stored.

\* The NOTE parameter is calculated based on the following values.

$$\begin{array}{llllll} \text{♩} = 1/4 & \text{♪} = 1/8 & \text{♫} = 1/16 & \text{♩} = 1/12 & \text{♩} = 3/32 & \text{♩} = 1/8 & \text{♩} = 1/6 \\ \text{♩} = 3/16 & \text{♩} = 1/4 & \text{♩} = 3/8 & \text{♩} = 1/2 & \text{♩} = 3/4 & \text{♩} = 1/1 & \text{♩} = 2/1 \end{array}$$

**Using the Freeze effect**

This section explains how to use the “FREEZE” effect type, which provides the functionality of a simple sampler. When this effect type is selected, you can perform operations on screen to record (sample) and play back a sound.

**NOTE**

Effect types “FREEZE” and “HQ.PITCH” can be used only in rack 1, 3, 5, or 7.

**STEP**

1. In the Function Access Area, press the RACK button.
2. Press the EFFECT tab in the VIRTUAL RACK window.
3. Press the effect container in rack 1, 3, 5, or 7.
4. Press the effect type field in the EFFECT EDIT window to open the EFFECT TYPE window, and select “FREEZE.”
5. To begin recording (sampling), press the REC button and then press the PLAY button.
6. To play back the recorded sample, press the PLAY button.

**NOTE**

- The bar in the EFFECT EDIT window reflects the current recording progress. When a fixed time has elapsed, the buttons will automatically turn off.
- You can adjust the parameters in the EFFECT EDIT window to make detailed settings for recording time, the way in which recording will begin, and the way in which the sample will play back. For details on the parameters, refer to the QL Data List (End of Manual).
- The sampled content will be erased if you record another sample, change the effect, or turn off the power to the QL unit.

## EFFECT EDIT window (when FREEZE is selected)

If the “FREEZE” effect type is selected, a PLAY button, REC button, and progress bar will appear in the special parameter field.

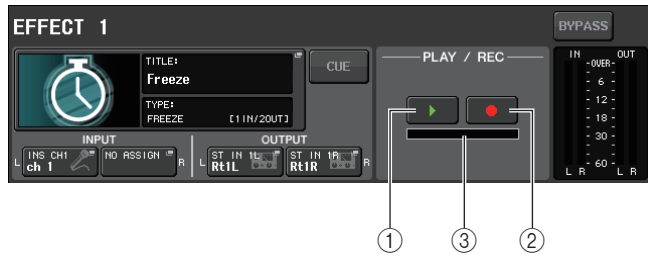

- ① PLAY button
- ② REC button
- ③ Progress bar

### NOTE

As an alternative to switching the effect type, you can also recall the “FREEZE” effect type from the effect library.

## Using the Premium Rack

The QL series console features processors that faithfully emulate meticulously-selected vintage analog processors, and a newly-developed Premium Rack, as well as graphic EQs and built-in effects. The Premium Rack employs VCM technology, which models analog circuitry on a component level to faithfully reproduce and fine-tune amazing analog sounds. The Premium Rack offers six types of processors.

Name	Outline
Portico 5033	Models RND’s analog 5-band EQ.
Portico 5043	Models RND’s analog compressor/limiter.
U76	Models a typical vintage compressor/limiter.
Opt-2A	Models a classic vacuum tube (optical type) compressor.
EQ-1A	Models a classic vacuum tube passive-type vintage EQ.
Dynamic EQ	Newly-developed EQ that features a dynamically changing gain and enables you to control the cut/boost amount in relation to the input level.

## Using the Premium Rack

The procedure to set up the I/O patches for the rack are the same as those for the effect rack (page 112).

For the premium rack, only racks 1–2 can be used via send/return. Racks 3–8 are only for patching as inserts. (Refer to “Virtual rack operations” on page 103.)

### STEP

1. In the Function Access Area, press the RACK button.
2. Press the PREMIUM tab in the upper part of the VIRTUAL RACK window.
3. To mount a Premium Rack in the rack, press the rack mount button for that rack in the PREMIUM RACK field.
4. Select the processor to mount and the mounting method in the MODULE SELECT field in the PREMIUM RACK MOUNTER window, and press the OK button.
5. Press the INPUT PATCH L button to open the CH SELECT window, and select the input source.
6. Press the OUTPUT PATCH L button to open the CH SELECT window, and select the insert-in of the same channel as the output destination.
7. Use the Bank Select keys and the [SEL] key to select the channel into which you inserted the effect.
8. Press the popup button in the INSERT field in the SELECTED CHANNEL VIEW screen.
9. In the INSERT/DIRECT OUT popup window, turn on the INSERT ON/OFF button for the channel into which you inserted the processor.
10. Adjust the processor parameters.
11. Using the fader of the channel you selected as the rack’s output destination in step 6, adjust the level as appropriate.

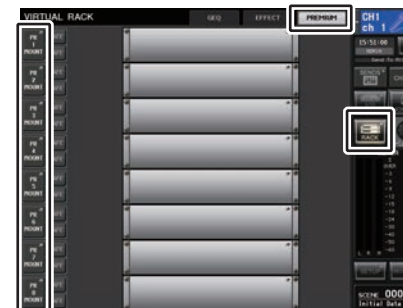

VIRTUAL RACK window (PREMIUM RACK field)



PREMIUM RACK MOUNTER window



**NOTE**

- If you are inserting a processor into a channel that handles a stereo source, assign the R channel insert-out and insert-in to the R input and output of the processor in the same way as steps 5 and 6.
- For details on editing the parameters, refer to the next section “Editing the Premium Rack parameters.”
- Adjust the digital gain and the processor parameters so that the signal does not reach the overload point at the input or output stage of the processor.

**■ Mounting a processor**

There are two ways to mount each processor:

- **DUAL** .....The processor is used on two mono channels.
- **STEREO** .....The processor is used on one stereo channel.

The DUAL button and STEREO button indicate how many rack space units are occupied by the Premium Rack processor.



The U76 occupies two rack spaces. Other processors occupy one rack space. If you mount a two-space Premium Rack processor in the rack, you will be unable to mount any more processors below those rack spaces. Also, you cannot mount a two-space processor in an even-numbered rack.



**Editing the Premium Rack parameters**

Each Premium Rack window includes the following items:



- ① **ASSIST button**  
Press this button to indicate the numbers that control each parameter.
- ② **LIBRARY button**  
Press this button to display the Library window for Premium Rack (for each module type).
- ③ **DEFAULT button**  
Restores the default parameter setting.

**NOTE**

- If the ASSIST button is on, you will be able to easily identify the parameters that are currently available for editing, and the parameters that will be available for editing after you select them.
- You can adjust the parameter in finer steps by turning a [TOUCH AND TURN] knob while pressing and holding it down.
- Pressing a top panel [SEL] key while operating the premium rack parameter will switch to the popup window of GEQ, effect, or premium rack that is inserted in that channel.



## ■ Portico 5033

Portico 5033 is a processor that emulates a 5-band analog EQ developed by Rupert Neve Designs (RND). 5033EQ features a unique tone control response. It inherited the history of the “1073,” which was praised as one of the greatest devices developed by Mr. Rupert Neve. Yamaha’s VCM technology has modeled the EQ to the last detail, including the input/output transformer that was designed by Rupert Neve himself. As a result, this processor model produces musically high-quality sound even when bypassed. Its response features unique effects. For example, if the Lo setting is cut, the low range becomes tight, and if the Hi setting is raised, the desired range will be boosted without hurting your ears.

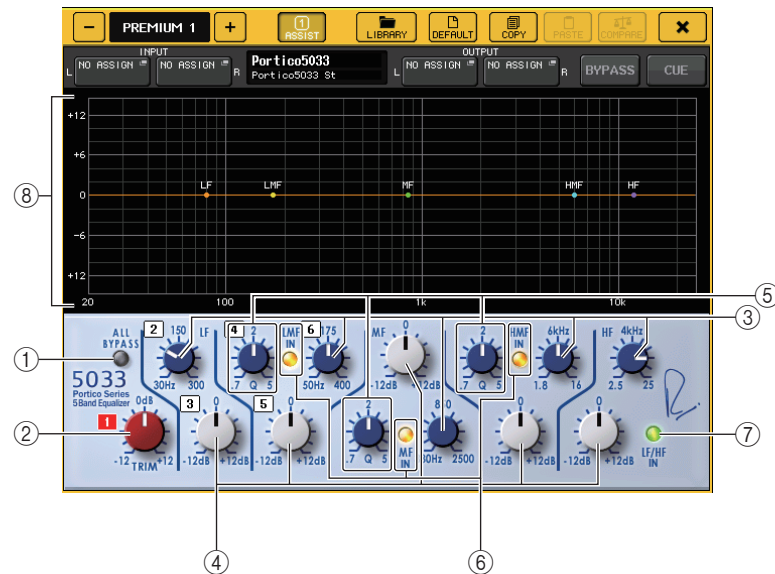

### ① ALL BYPASS button

Switches EQ bypass on or off. Even when EQ bypass is on, the signal will pass through the input/output transformer and amp circuits.

### ② TRIM knob

Adjusts the input gain of the processor.

### ③ LF/LMF/MF/HMF/HF Frequency knobs

Adjust the frequency for each band.

### ④ LF/LMF/MF/HMF/HF Gain knobs

Adjust the amount of boost or cut for each band.

### ⑤ LMF/MF/HMF Q knobs

Adjust the Q (steepness) of each band. The higher the Q value, the narrower the range in which you can control the gain for the band.

### ⑥ LMF/MF/HMF IN button

Turn LMF/MF/HMF EQ on or off respectively.

### ⑦ LF/HF IN button

Turn LF and HF EQ on or off simultaneously.

### ⑧ Graph

Indicates the graphical EQ response.

## ■ Portico 5043

Portico 5043, like Portico 5033, is a processor that emulates RND’s analog compressor. The actual 5043 compressor is equipped with the same input/output transformer as that of the 5033 EQ, delivering a natural, analog-like tonality and effect. It enables you to obtain a range of results from hard compression to natural sound, and is suitable for a broad range of audio sources ranging from drums to vocals. The most notable feature of this model is that you can switch the gain reduction type. You can choose either an FF (Feed-Forward) circuit type (which is the current mainstream), or an FB (Feed-Back) circuit which was typically used in vintage compressors. This allows you to create sounds with various characteristics as appropriate for your applications.

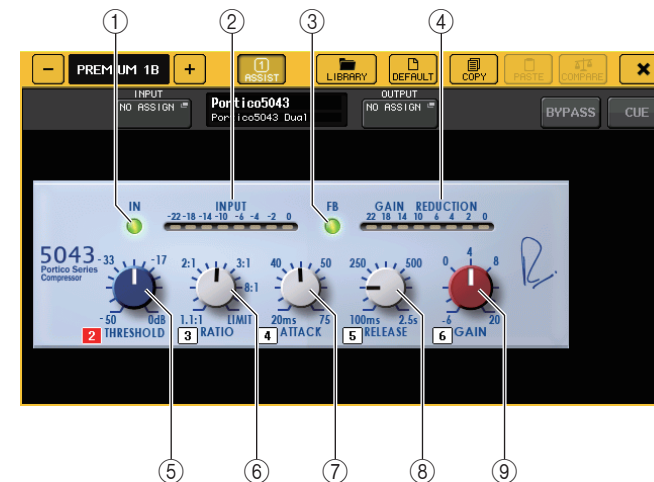

### ① IN button

Turns the compressor’s bypass on or off. When the compressor is bypassed, the button indicator will turn off. However, even if the compressor is bypassed, the signal will pass through the input/output transformer and amp circuits.

### ② INPUT meter

Indicates the input signal level.

One meter appears in DUAL mode, and two meters appear in STEREO mode.

③ **FB button**

Switches the gain reduction method between FF (Feed-Forward) circuit and FB (Feed-Back) circuit. The button will light when FB circuit is selected.

The FF circuit is used in most contemporary compressors. This type is useful when you want to apply consistent compression while maintaining a consistent tonal color.

The FB circuit is used in vintage compressors. This type is suitable when you want to apply a smooth compression while adding a tonal character that is characteristic of such devices.

④ **GAIN REDUCTION meter**

Indicates the amount of gain reduction.

⑤ **THRESHOLD knob**

Adjusts the threshold at which compression starts to be applied.

⑥ **RATIO knob**

Adjusts the compression ratio. Fully rotate the knob clockwise to switch to the limiter.

⑦ **ATTACK knob**

Adjusts the compressor's attack time.

⑧ **RELEASE knob**

Adjusts the compressor's release time.

⑨ **GAIN knob**

Adjusts the output gain.

■ **U76**

U76 is a processor that emulates a popular vintage compressor used in a wide range of situations. This processor does not provide the threshold parameter that is found on conventional compressors. Instead, the intensity of compression is determined by the balance between the input gain and the output gain. The "All mode" setting for the RATIO parameter allows you to create a heavily-compressed sound that is typical of this model. It produces an aggressive tonal character with a rich addition of overtones.

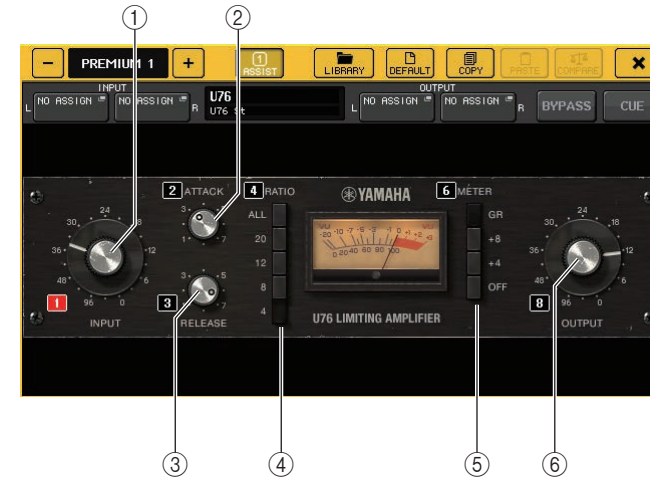
① **INPUT knob**

Adjusts the input level. As the input level gets higher, more compression is applied.

② **ATTACK knob**

Adjusts the compressor's attack time. Fully rotate the knob clockwise to set the fastest attack time.

③ **RELEASE knob**

Adjusts the compressor's release time. Fully rotate the knob clockwise to set the fastest release time.

④ **RATIO switch buttons**

Use these five buttons to set the compression ratio.

A button with a higher number will raise the compression ratio more. Pressing the ALL button selects All mode, in which the RATIO will become high, and sharp compression with a faster release time will be applied, creating substantially-distorted aggressive sound.

### ⑤ METER switch buttons

Switch the meter display.

- **GR**.....Indicates the amount of gain reduction applied by the compressor.
- **+4/+8**.....Each meter uses  $-18$  dB as the reference level of the output signal, and indicates “OVU” for the value of the reference level added by  $+4$  dB or  $+8$  dB.
- **OFF** .....Turns off the meter display.

### ⑥ OUTPUT knob

Adjusts the output level.

If you have adjusted the amount of gain reduction by changing the INPUT knob, the level of audible volume will also change. In this case, use the OUTPUT knob to adjust the volume level.

## ■ Opt-2A

Opt-2A is a processor that emulates a popular vintage model of tube optical compressors. It features smooth compression produced using optical components such as a CdS cell and an EL panel to control the level. It also features beautiful high-range overtones created by the warm distortion typical of tube circuits, resulting in elegant and sophisticated sounds.



### ① GAIN knob

Adjusts the output level.

### ② PEAK REDUCTION knob

Adjusts the compression amount of the signal.

### ③ RATIO knob

Adjusts the compression ratio.

### ④ METER SELECT knob

Switches the meter display.

GAIN REDUCTION indicates the amount of gain reduction applied by the compressor. With  $-18$  dB as the reference level of the output signal, the OUTPUT  $+10$  and OUTPUT  $+4$  settings respectively will cause the value  $+10$  dB or  $+4$  dB from this reference level to be shown as “OVU” on the meter.

## EQ-1A

EQ-1A is a processor that emulates a famous passive-type vintage EQ. It features a unique style of operation, allowing you to individually boost and attenuate (cut) each of two frequency ranges (high and low). The frequency response is utterly unlike that of a conventional EQ, and is a uniquely distinctive characteristic of this model. The input/output circuits and vacuum tubes produce a tonal character that is highly musical and well-balanced.



### ① IN switch

Turns the processor on or off.

When the switch is off, the signal will bypass the filter section, but pass through the input/output transformer and amp circuits.

### ② LOW FREQUENCY knob

Sets the frequency of the low range filter.

### ③ (LOW) BOOST knob

Sets the amount of boost applied to the frequency band specified by the LOW FREQUENCY knob.

### ④ (LOW) ATTEN knob

Sets the amount of attenuation applied to the frequency band specified by the LOW FREQUENCY knob.

### ⑤ BAND WIDTH knob

Sets the width of the frequency band controlled by the high range filter.

As you rotate the knob toward the right (Broad), the band will become wider and the peak level will decrease. This affects only the response of the boost.

### ⑥ HIGH FREQUENCY knob

Sets the frequency of the high range filter. This affects only the response of the boost.

### ⑦ (HIGH) BOOST knob

Sets the amount of boost applied to the frequency band specified by the HIGH FREQUENCY knob.

### ⑧ (HIGH) ATTEN knob

Sets the amount of attenuation applied to the frequency band specified by the ATTEN SEL knob.

### ⑨ (HIGH) ATTEN SEL knob

Switches the frequency region attenuated by the ATTEN knob.

## Dynamic EQ

Dynamic EQ is a newly-developed equalizer that does not emulate any specific model of equalizer. The sidechain has a filter that extracts the same frequency band as the EQ. This allows you to apply EQ in the same way as you might apply a compressor or expander to a specific frequency region, causing the EQ gain to vary dynamically only when a specific frequency region of the input signal becomes too high or too low. For example you could use this on a vocal sound as a de-esser, so that EQ is applied to a specific frequency band only when sibilance or high-frequency consonants reach an unpleasant level, thus preserving a natural sound that does not impair the original tonal character. Two full-band Dynamic EQs are provided, enabling you to process a wide range of audio sources.

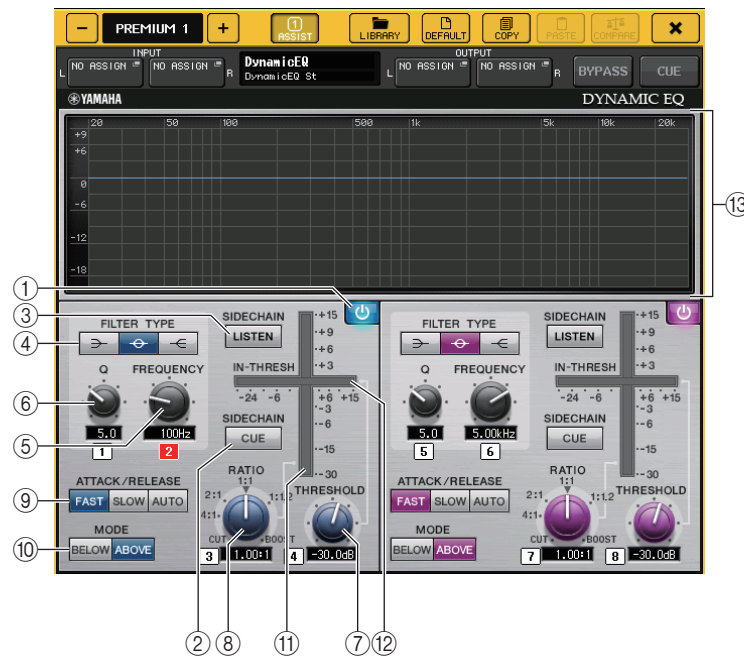

### ① BAND ON/OFF button

Turns each band on or off.

**② SIDECHAIN CUE button**



Turn this button on to monitor the sidechain signal sent to the CUE bus. At this time, the graph indicates the response of the sidechain filters.

**③ SIDECHAIN LISTEN button**

Turn this button on to output the sidechain signal (linked to the dynamics) to the bus (such as a STEREO bus or MIX/MATRIX bus) to which the insert channel signal is sent. At this time, the graph indicates the response of the sidechain filters.

**④ FILTER TYPE buttons**

Switch the type of the main bus equalizers and sidechain filters. Main bus EQ and sidechain filter will link as follows:

FILTER TYPE	 (Low Shelf)	 (Bell)	 (Hi Shelf)
Main EQ	Low Shelf	Bell	Hi Shelf
Sidechain filter	LPF	BPF	HPF

**⑤ FREQUENCY knob**

Sets the frequency band that will be controlled by the equalizer and sidechain filter.

**⑥ Q knob**

Sets the Q value (steepness) of the equalizer and sidechain filter.

As you rotate this knob clockwise, the frequency range to which the equalizer or sidechain filter is applied will become wider.

**⑦ THRESHOLD knob**

Specifies the threshold at which the processor will begin taking effect.

**⑧ RATIO knob**

Sets the boost/cut ratio relative to the input signal.

Rotating the knob clockwise will set the ratio for boost, and counter-clockwise for cut. Fully rotating the knob in either direction will create the maximum effect.

**⑨ ATTACK/RELEASE buttons**

Enable you to select one of the three settings as the attack/release time for compression or boost.

Select FAST for a faster attack and faster release. Select SLOW for a faster attack and slower release. Select AUTO to automatically adjust the attack/release time depending on the frequency ranges.

**⑩ MODE buttons**

Specify whether the processor is triggered when the sidechain signal level exceeds the threshold value (ABOVE), or when the level does not reach the threshold value (BELOW).

**⑪ EQ GAIN meter**

Indicates the dynamically-changing EQ gain.

**⑫ THRESHOLD meter**

Indicates the sidechain signal level in relation to the threshold level.

**⑬ Graph area**

Displays the equalizer response.

In most cases, this area displays the reference EQ graph that indicates the frequency and intensity, and the dynamic EQ graph that indicates the dynamically-changing EQ responses.

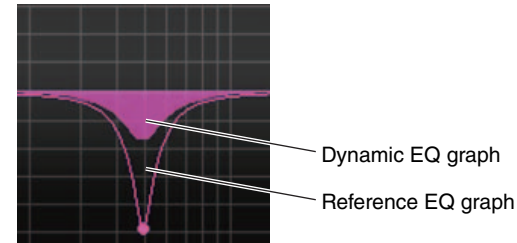

If SIDECHAIN CUE or SIDECHAIN LISTEN is on, this area displays the sidechain filter response.

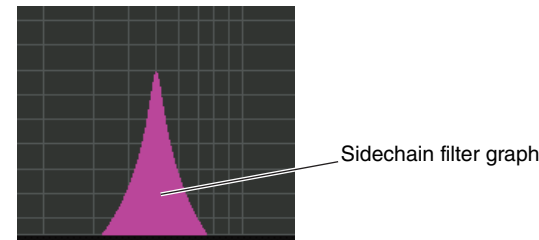

## Using the graphic EQ, effect, and Premium Rack libraries

### ■ GEQ library

Use the “GEQ library” to store and recall GEQ settings. All GEQ units used in the QL series console can use this GEQ library. Although there are two types, 31BandGEQ and Flex15GEQ, you are free to recall items between differing types. However, only 31BandGEQ settings that use less than fifteen bands can be recalled to a Flex15GEQ.

200 items can be recalled from the library. Number 000 is a read-only preset, and the remaining library numbers can be freely read or written.

To recall an item from the GEQ library, press the LIBRARY button located at the top of the GEQ EDIT window.



#### NOTE

- Store and recall operations are performed on individual GEQ units. For one rack, you can store and recall two Flex15GEQ units independently as A and B.
- To access the GEQ EDIT window, press the rack container in the GEQ field.

### ■ Effect library

Use the “Effect library” to store and recall effect settings. 199 items can be recalled from the effect library. Numbers 001–027 are read-only presets. The remaining library numbers can be freely read or written.

To recall an item from the effect library, press the LIBRARY button located at the top of the EFFECT EDIT window.



#### NOTE

If you recall an effect whose effect type is COMP276, COMP276S, COMP260, COMP260S, EQUALIZER610, OPENDECK, M.BAND DYNA., or M.BAND COMP, the other effects may be momentarily muted in some cases.

### ■ Premium Rack library

For the Premium Rack, there are six library items for each module type. You’ll use the library of the module type to store and recall Premium Rack settings. The libraries are numbered 000–100, and 000 is read-only data for initialization. All library items other than #000 can be freely read and written.

To recall an item from the Premium Rack library, press the LIBRARY button located at the top of the window for the corresponding Premium Rack.





# I/O devices and external head amps

This chapter explains how to use an I/O device or an external head amp that is connected to the QL series console. Before you proceed, use DANTE SETUP to specify the I/O devices that will be mounted. For details, refer to “Mounting an I/O device on the Dante audio network” on page 197.

## Using an I/O device

QL series consoles enable you to remotely control channel parameters of an I/O device (such as an Rio series product) connected to the Dante connector.

For details on connecting the QL series console to an I/O device, refer to the “Connecting to I/O devices” section in the separate Owner’s Manual.

## I/O device patching

Here’s how an I/O device connected to the Dante connector can be patched to the Dante audio network.

### STEP

1. **Connecting QL series consoles and I/O devices.**  
For details, refer to the “Connecting to I/O devices” and “Quick Guide” sections in the separate Owner’s Manual.
2. **In the function access area, press the I/O DEVICE button.**
3. **Press the DANTE PATCH tab in the upper part of the I/O DEVICE screen.**
4. **Press the DANTE INPUT PATCH button in the I/O DEVICE screen (DANTE PATCH page).**
5. **Press the AUTO SETUP button.**  
If you want to edit individual patches, press the port select button.
6. **Press the device in the I/O DEVICE screen (DANTE PATCH page).**
7. **Press the port select button in the OUTPUT PATCH window.**
8. **In the PORT SELECT screen, select the output port.**

## I/O DEVICE screen (DANTE PATCH page)



### 1 I/O device list

This shows the ID number and model name of the I/O devices.

Press here to access the OUTPUT PATCH window, where you can specify patching from the console’s output ports to the I/O devices. If a previously set-up device does not currently exist on the DANTE audio network, a yellow “Virtual” indicator is shown at the lower left of that device. If devices on the network belong to different DEVICE TYPEs but share the same ID, a red “Conflict” indicator will appear to the left, below the device. If multiple devices share the same ID, a yellow “Duplicate” indicator will appear to the right, below the device.

### 2 DANTE SETUP button

Press this button to open the DANTE SETUP window, in which you can make settings for the audio network.

### 3 DANTE INPUT PATCH button

Press this button to open the DANTE INPUT PATCH window, in which you can select the 64 channels (32 channels for the QL1) that will be input from the I/O device to the console.

### 4 OUTPUT PORT SETUP button

Press this button to access the PATCH VIEW 1 tab of the OUTPUT PORT window, where you can choose the 64 channels (32 channels for the QL1) that will be output from the console’s output ports to I/O devices.



## DANTE INPUT PATCH window

Displayed when you press the DANTE INPUT PATCH button in the I/O DEVICE screen (DANTE PATCH page). Specify the 64 channels that will be input from the I/O devices to the console.

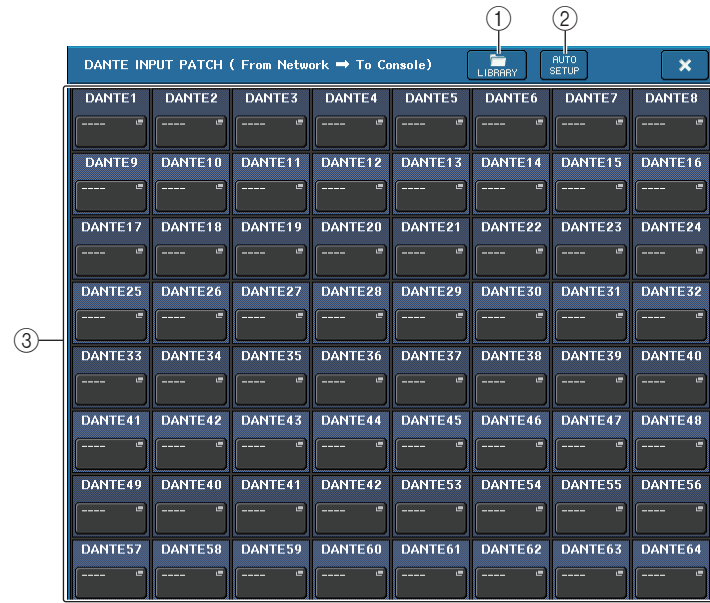

### ① LIBRARY button

Enables you to store or recall the DANTE INPUT PATCH settings to or from the library. You can store ten sets of settings in the library.

#### NOTE

- If you recall data whose I/O device registration state differs from the current state, patching to devices not registered in the I/O device list will be kept in its current state, and will not be recalled. (The settings are recalled for an R series console or an external QL series console.)
- Similarly, if the UNIT ID is different than when the data was stored, the settings will not be recalled; the current state will be maintained.

### ② AUTO SETUP button

The current I/O device connection status will be ascertained, and input patching to the console will be performed automatically according to the order in which they are registered in the I/O device list.

When you press this button, a confirmation popup dialog will appear, asking you to confirm the execution of auto patching. Press the OK button to execute auto patching. Otherwise, press CANCEL to return to the previous screen.

### ③ Port select buttons



Press to display the PORT SELECT window.

“Dante Device ID number (hexadecimal) and channel number (decimal)” are shown in the upper row on the button.

The first eight characters of the channel label (Dante Audio Channel Label) for each port are shown in the lower row on the button.

If no patch has been assigned, the upper row will indicate “---” and the lower row will indicate nothing.

#### NOTE

- If you’ve connected a device other than an I/O device supported by the QL series, the upper line of the button will show the first four letters of the Device Label, a dash “—”, and the channel number (decimal).
- If no Dante Audio Channel Label has been specified, the lower row will indicate nothing.
- You can set the Dante Audio Channel Label using Audinate “Dante Controller” software. For the latest information, refer to the Yamaha pro audio website. <http://www.yamahaproaudio.com/>

## PORT SELECT window

Displayed when you press the port select button in the DANTE INPUT PATCH window or OUTPUT PATCH window. When you change a patch, select the I/O port.

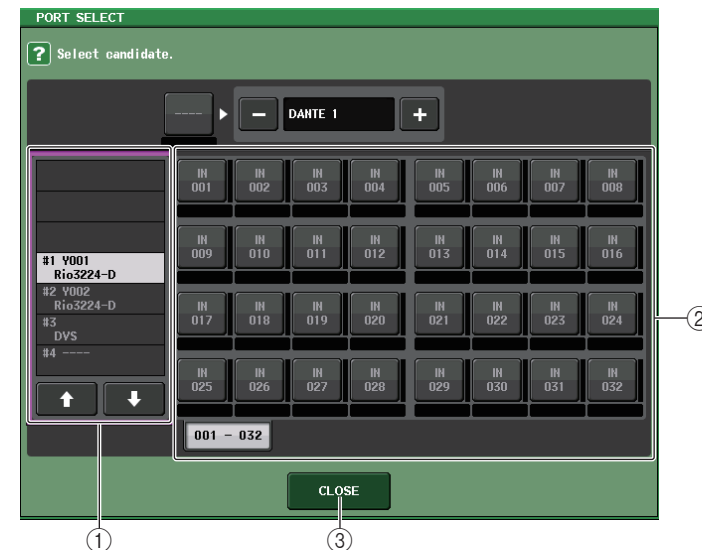

### ① Category select list

Enables you to select the I/O device containing the input port that you want to assign.

### ② Port select buttons

Select the input port.

③ **CLOSE button**

Completes the settings and closes the window.

## OUTPUT PATCH window

Displayed when you press the device in the I/O DEVICE screen (DANTE PATCH page). Set the output patch.

① **Port select buttons**

Press one of the buttons to open the PORT SELECT popup window.

## Remotely controlling an Rio unit

This section explains how to remotely control an Rio unit that's connected to the Dante connector.

### STEP

1. In the upper part of the I/O DEVICE screen, press the Rio tab to display the I/O DEVICE screen (Rio page).
2. Press the rack in which the I/O device on the head amp side is mounted.
3. Remotely control the head amp of the I/O device.
4. To remotely control a head amp from an input channel, press a knob in the SELECTED CHANNEL section to display the SELECTED CHANNEL VIEW screen.
5. Press the GAIN/PATCH field of the channel you want to adjust. The GAIN/PATCH window will appear.
6. Control the head amp of the I/O device in the GAIN/PATCH window.
7. When you have finished making settings, press the "x" symbol to close the window.
8. Press the rack in which the I/O device on the OUTPUT side is mounted.
9. Set the output port on the OUTPUT PATCH window, as necessary.  
Refer to step 7 in "I/O device patching" on page 127.

## I/O DEVICE screen (Rio page)



### ① Display switch buttons

Press one of these buttons to view the corresponding I/O device. If you press and hold down this button, all LEDs of the corresponding I/O device will blink. For more information about VIRTUAL/CONFLICT/DUPLICATE displayed below this button, refer to ① on [page 127](#), "I/O device list."

### ② ID/Model name display

This shows the ID number, model name, and version of the I/O device.

### ③ DANTE SETUP button

Press this button to open the DANTE SETUP window, in which you can make settings for the audio network.

## ■ HA display

This shows the HA settings of the I/O device. Press this area to open the I/O DEVICE HA window, in which you can make detailed head amp settings.

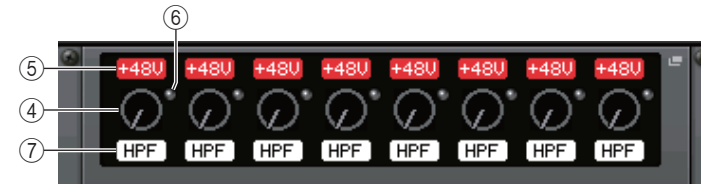

### ④ Analog GAIN knob

Indicates the analog gain setting. This screen is only for display; the value cannot be edited.

### ⑤ +48V indicator

Indicates the phantom power (+48V) on/off status for each port.

### ⑥ OVER indicator

Warns you when the input signal is clipping.

### ⑦ HPF indicator

Indicates the high-pass filter on or off status for each port.

## ■ INPUT display

This shows the input settings of the I/O device.



If you press the [SEL] key of an input channel, the corresponding port will light. (It does not light for external QL series consoles.)

## ■ OUTPUT display

This shows the output settings of the I/O device. Press here to access the OUTPUT PATCH window, where you can make output port settings for the I/O device.



If you press the [SEL] key of an output channel, the corresponding port will light. (It does not light for external QL series consoles.)

## I/O DEVICE HA window

Displayed when you press the rack in which the I/O device on the head amp side is mounted. You can remotely control the head amp of the I/O device from the QL series console by using the on-screen knobs and buttons or the [TOUCH AND TURN] knob on the top panel.



- ① **+48V MASTER**  
Indicates the on/off status of the I/O device's master phantom power. (Switching this on or off is performed on the I/O device itself.)
- ② **+48V button**  
These switch phantom power on/off for each channel.
- ③ **GAIN knob**  
Indicates the gain of the head amp on the I/O device. To adjust the value, press the knob to select it, and then use the [TOUCH AND TURN] knob. The level meter located at the immediate right of the knob indicates the input level for the corresponding port.
- ④ **GC button**  
Switches on or off the Gain Compensation function that maintains a consistent signal level on the audio network.
- ⑤ **FREQUENCY knob/HPF button**  
These controllers switch on or off the high-pass filter built into the head amp of the I/O device, and adjust its cutoff frequency. If you press and select the FREQUENCY knob, you can make adjustments using the [TOUCH AND TURN] knob.
- ⑥ **Displayed port switch tabs**  
These tabs switch the port that is displayed in the I/O DEVICE HA window.
- ⑦ **GC ALL ON button/GC ALL OFF button**  
Switch Gain Compensation on or off for all input channels simultaneously.

## Remotely controlling from the input channels

To remotely control the I/O device's head amp from an input channel of the QL series console, operate the GAIN/PATCH window for the channel for which you want to control.



## Remotely controlling an amp

This section explains how to remotely control an AMP unit that's connected to the Dante connector.

### STEP

1. Press the AMP tab in the upper part of the I/O DEVICE screen.
2. Press the I/O device displayed on the I/O DEVICE screen (AMP page).
3. Set the output port on the OUTPUT PATCH window, as necessary.  
Refer to step 7 in "I/O device patching" on page 127.

## I/O DEVICE screen (AMP page)

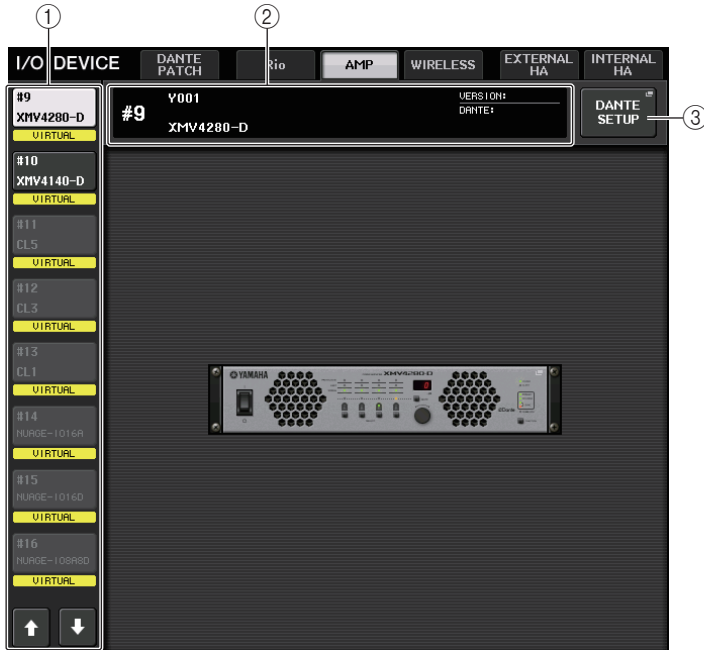

### ① Display switch buttons

Press one of these buttons to view the corresponding I/O device.  
For more information about VIRTUAL/CONFLICT/DUPLICATE displayed below this button, refer to ① on [page 127](#), “I/O device list.”

### ② ID/Model name display

This shows the ID number, model name, and version of the I/O device.

### ③ DANTE SETUP button

Press this button to open the DANTE SETUP window, in which you can make settings for the audio network.

## Remotely controlling WIRELESS unit

This section explains how to remotely control a WIRELESS unit that’s connected to the Dante connector.

### STEP

1. Press the WIRELESS tab in the upper part of the I/O DEVICE screen.
2. Press the I/O device displayed in the I/O DEVICE screen (WIRELESS page).
3. Set the output port on the OUTPUT PATCH window, as necessary.  
Refer to step 7 in “I/O device patching” on [page 127](#).

## I/O DEVICE screen (WIRELESS page)

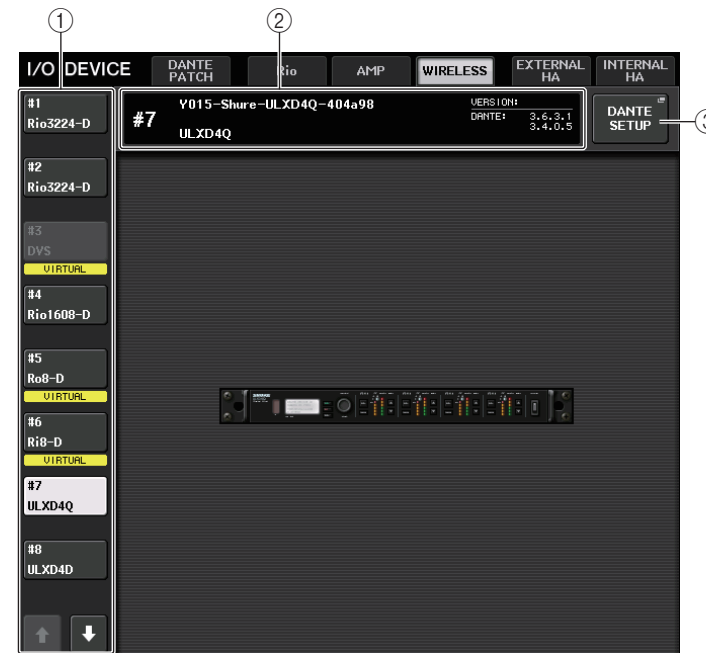

### ① Display switch buttons

Press one of these buttons to view the corresponding I/O device.  
For more information about VIRTUAL/CONFLICT/DUPLICATE displayed below this button, refer to ① on [page 127](#), “I/O device list.”

### ② ID/Model name display

This shows the ID number, model name, and version of the I/O device.

### ③ DANTE SETUP button

Press this button to open the DANTE SETUP window, in which you can make settings for the audio network.

## Using an external head amp

If an I/O card (such as an MY16-ES64 card) supports the remote protocol of an external head amp in the QL's slot, you will be able to remotely control from the QL console some parameters of the external head amp (Yamaha SB168-ES or AD8HR), such as phantom power (+48V) on/off status, gain, and HPF.

For details on the I/O card settings, refer to the Owner's Manual for the I/O card.

## Connecting the QL series console to an AD8HR

To remotely control the AD8HR from the QL series console, install an MY16-ES64 EtherSound card in Slot 1 on the QL unit, then use an Ethernet cable to connect the QL unit to the NAI48-ES. Then, connect the HA REMOTE connector on the NAI48-ES to the HA REMOTE 1 connector on the AD8HR using an RS422 D-sub 9-pin cable. This connection enables you to remotely control the AD8HR from the QL series console. To transmit audio signals (input to the AD8HR) to the QL series console, connect the DIGITAL OUT A (or B) connector on the AD8HR to the AES/EBU connector on the NAI48-ES using a D-sub 25-pin AES/EBU cable. Signals will be sent or received between the NAI48-ES and the QL series console via the MY16-ES64 card.

Alternatively, you can use a "daisy chain" connection to remotely control multiple AD8HR units simultaneously. To do this, connect the AD8HR's HA REMOTE 2 connector to the second AD8HR's HA REMOTE 1 connector. If you use the NAI48-ES, you can connect up to four AD8HR units. Each slot of the QL series console provides up to 16 channels of input, so if you want the audio signals from the AD8HR to be input to the QL series console, you'll need to install two MY16-EX cards in the console and connect the MY16-ES64 via an Ethernet cable.

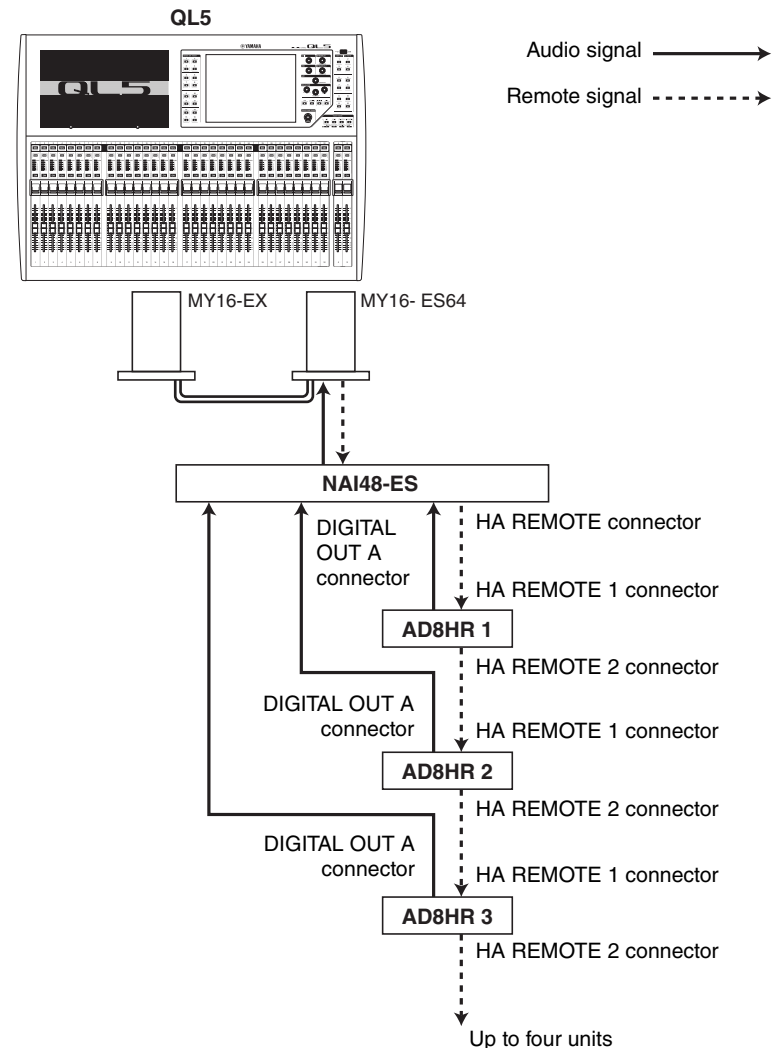

## Connecting the QL series console to an SB168-ES

To remotely control the SB168-ES from the QL series console, install an MY16-ES64 EtherSound card in Slot 1 on the QL unit, then use an Ethernet cable to connect the QL unit to the SB168-ES. This connection enables you to remotely control the SB168-ES from the QL series console.

Alternatively, you can use a daisy chain or ring connection and install one MY16-EX expansion card in the slot on the QL unit to remotely control up to two SB168-ES units simultaneously.

### NOTE

Remote control data will be received and transmitted only at Slot 1 of the QL series console.

### ■ Daisy chain network

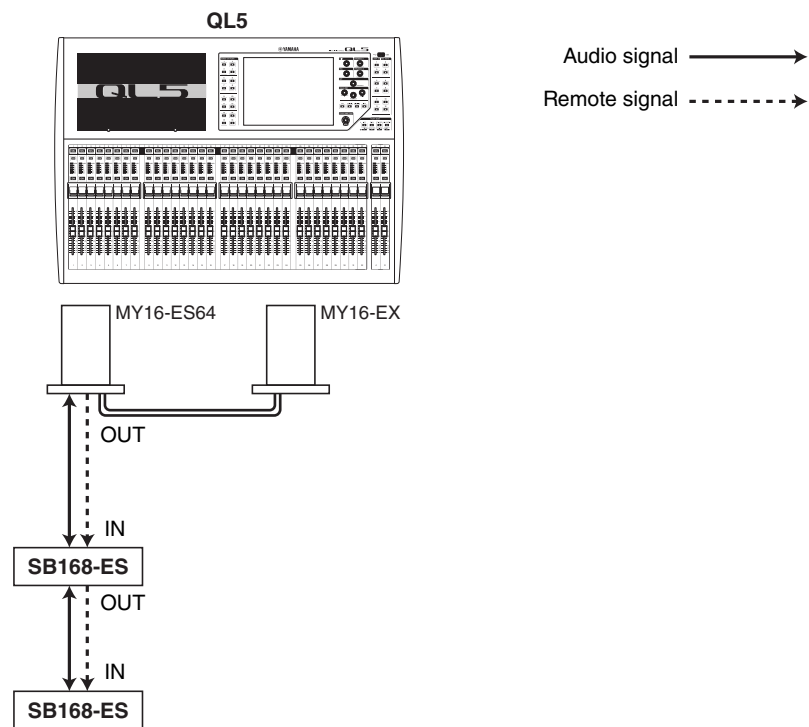

### ■ Ring connection

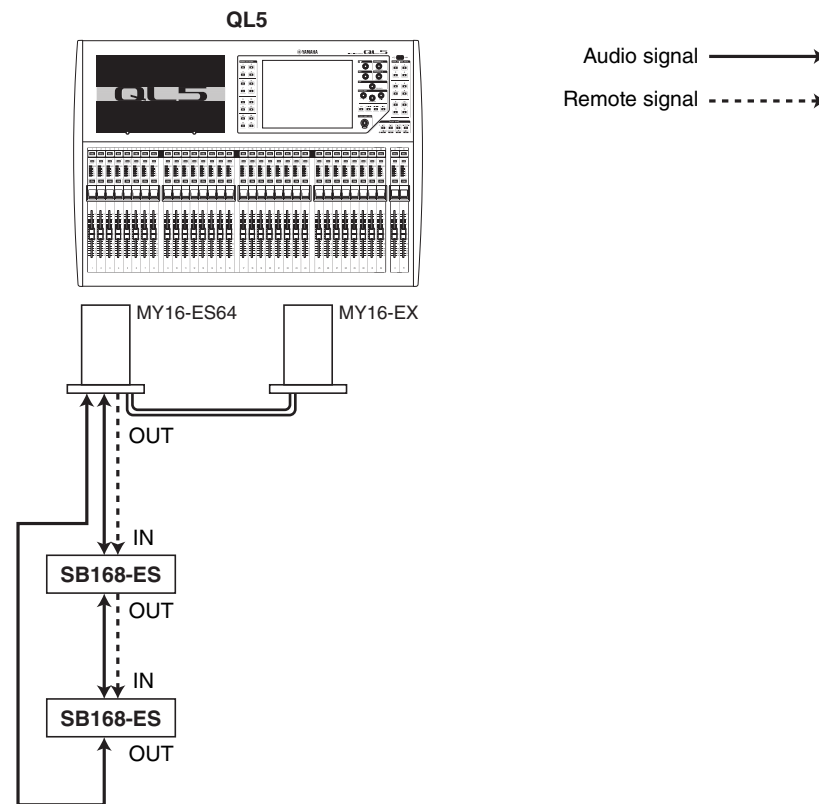

### NOTE

Please refer to the SB168-ES Owner's Manual for information on setting up the MY16-ES64/ MY16-EX cards and EtherSound network.



## Remotely controlling an external head amp

An external head amp (“external HA”) connected via MY16-ES64 or NAI48-ES can be remotely controlled from the QL series console. For details on how to connect a QL series console with an external head amp, refer to “Using an external head amp” on page 133 and the external head amp’s operating manual.

### STEP

1. Connect the QL series console to an external HA.
2. In the function access area, press the RACK button.
3. Press the EXTERNAL HA tab in the upper part of the I/O DEVICE screen.
4. Press the EXTERNAL HA PORT SELECT button for the corresponding rack in the I/O DEVICE screen (EXTERNAL HA page).
5. Use the PORT SELECT buttons in the EXTERNAL HA PORT SELECT window to select the input ports to which the audio output of the external HA is connected.
6. Press the CLOSE button to close the EXTERNAL HA PORT SELECT window.
7. In the I/O DEVICE screen (EXTERNAL HA page), press the rack in which the external HA you want to control is mounted.
8. Remotely control the external head amp in the EXTERNAL HA window.

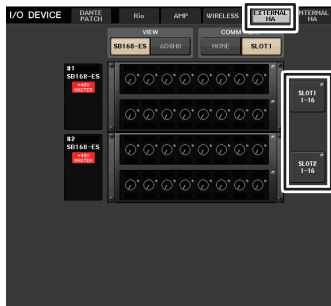

VIRTUAL RACK screen  
(EXTERNAL HA page)

## I/O DEVICE screen (EXTERNAL HA page)

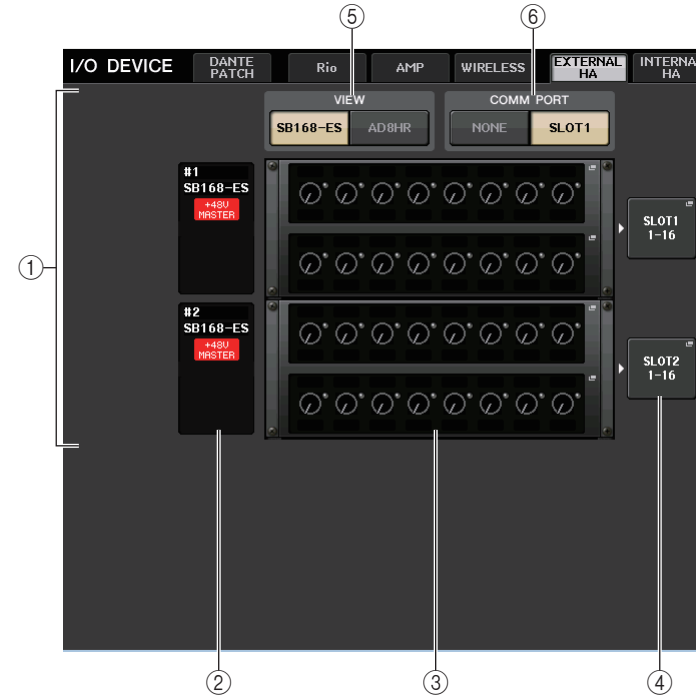

### ① EXTERNAL HA field

Shows the state of the connected external HA.

### ② ID/Model name/+48V master

This displays information for the external HA mounted in the rack. The ID number is automatically assigned in order of the connected devices from 1 to 4. This field also enables you to view the on/off status of the master phantom power.

### ③ Virtual racks

These are up to four racks in which remotely controllable external HA units can be mounted. If an external HA is mounted, this field will indicate the HA settings (GAIN setting, and on/off status of the phantom power and HPF). Press a rack to open the EXTERNAL HA window for that rack.

### ④ EXTERNAL HA PORT SELECT button

Press this button to display the HA PORT SELECT window, in which you can set the input port for the external head amp mounted in the rack.

### NOTE

If an external HA is connected to one of the slots on the QL series console, you must specify an appropriate input port manually. If this is set incorrectly, the external HA will not be detected correctly when you patch input ports to input channels.

⑤ **VIEW switch buttons**

Switch the virtual rack display between SB168-ES and AD8HR. Select the view that's appropriate for the connected device.

⑥ **COMM PORT switch buttons**

Specify whether the external HA connected to the slot will be controlled remotely. Select "SLOT1" if you want to remotely control the external HA.

**EXTERNAL HA PORT SELECT window**

Select the input port for the external head amp. Display this window by pressing the EXTERNAL HA PORT SELECT button in the I/O DEVICE screen (EXTERNAL HA page).

① **PORT SELECT buttons**

Specify the input ports to which the external HA is connected.

**EXTERNAL HA window**

Remotely control the external head amp. Display this window by pressing the virtual rack in the I/O DEVICE screen (EXTERNAL HA page).

① **+48V MASTER**

If an external HA is connected, the master phantom power on/off status is shown here. (The on/off setting is made on the external HA unit itself.)

② **+48V button**

These switch phantom power on/off for each channel.

③ **GAIN knob**

These indicate the gain of the external HA. If you press and select the GAIN knob, you can make adjustments to gain using the [TOUCH AND TURN] knob. The level meter located at the immediate right of the knob indicates the input level for the corresponding port.

④ **FREQUENCY knob/HPF button**

These controllers switch on or off the high-pass filter built into the external HA, and adjust its cutoff frequency. If you press and select the FREQUENCY knob, you can make adjustments using the [TOUCH AND TURN] knob.

⑤ **Rack select tabs**

These tabs switch the rack that is displayed in the EXTERNAL HA window.

**NOTE**

- If you connect an additional AD8HR, the setting for this AD8HR will be used. These knobs and buttons are displayed in the EXTERNAL HA window even if an AD8HR is not connected, allowing you to create and store a scene even while the AD8HR is not connected.
- Error messages related to the SB168-ES will not be displayed. In addition, you will be unable to set the EtherSound parameters. Use AVS-ESMonitor for these functions.

## Remotely controlling an external HA from the input channels on a QL series console

You will be able to use the external HA in the same way as the head amp on an I/O device or on the QL console. For details on the GAIN/PATCH window, refer to “Making HA (Head Amp) settings” on page 26.

### STEP

1. Use the Bank Select keys and the [SEL] key to access the SELECTED CHANNEL VIEW screen that includes the channel for the head amp that you want to control.
2. Press the GAIN/PATCH field of the channel whose external HA you want to adjust.
3. Press the PATCH button in the GAIN/PATCH window, and select the input port assigned to the external HA.
4. Remotely control the external head amp in the GAIN/PATCH window.



## Controlling an internal head amp

Control the internal head amps (“internal HA”) in QL series consoles. It is not necessary to change the input patch.

### STEP

1. Press the INTERNAL HA tab in the upper part of the I/O DEVICE window.
2. Set the output port on the INTERNAL HA window, as necessary.



I/O DEVICE screen (INTERNAL HA page)

## INTERNAL HA window



- ① **+48V MASTER**  
Indicates the master phantom power on or off status.
- ② **+48V button**  
These switch phantom power on/off for each channel.
- ③ **A. GAIN knob**  
These indicate the gain of the internal HA. To adjust the value, press the knob to select it, and then use the [TOUCH AND TURN] knob. The level meter located at the immediate right of the knob indicates the input level for the corresponding port.
- ④ **GC button**  
Switches on or off the Gain Compensation function that maintains a consistent signal level on the audio network.
- ⑤ **Displayed port switch tabs**  
These tabs switch the port that is displayed in the INTERNAL HA window

# MIDI

This chapter explains how to transmit MIDI messages from an external device to the QL series console to control the QL console's parameters, and how to send out MIDI messages from the QL console as you operate the unit.

The following illustration shows an example of connecting the MIDI IN/OUT connectors to transmit and receive MIDI messages.

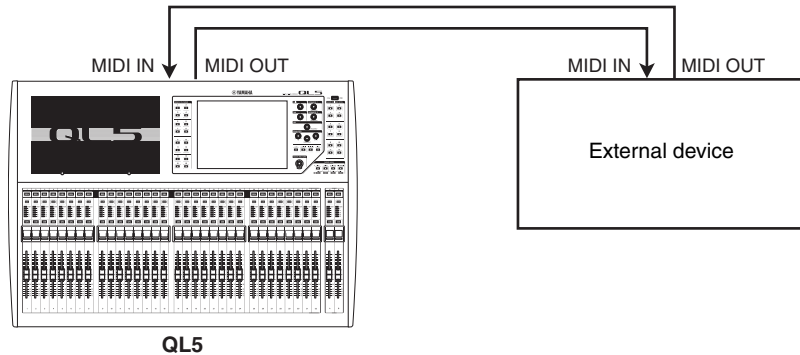

## MIDI functionality on the QL series console

The QL series console can use MIDI to perform the following operations.

### ■ Program Change transmission and reception

When you execute a specific event (scene/effect library recall) on the QL series console, a Program Change message (a number that is assigned to the event) can be transmitted to an external device. Conversely, the corresponding event can be executed when a Program Change message is received from an external device.

### ■ Control Change transmission and reception

When you execute a specific event (fader, knob, or key operation) on the QL series console, the corresponding Control Change message can be transmitted to an external device. Conversely, events can be executed when Control Change messages are received from an external device. This allows you to record fader and key operations on a MIDI sequencer or other external device, and play them back later.

### ■ Parameter Change (SysEx) transmission and reception

When specific events (fader, knob, or key operations, changes in system settings or user settings) are executed, "Parameter Change" SysEx (system exclusive) messages can be transmitted to an external device. Conversely, events can be executed when Parameter Changes are received from an external device. Using this capability, QL operations can be recorded and played back on a MIDI sequencer or other external device. In addition, changes in system and user settings can be received and executed by another QL console.

### NOTE

As the port used for transmission and reception of MIDI messages, you can select either the rear panel MIDI IN/OUT connectors or an I/O card installed in slot 1. All of the functionality described in this section will be available on the port you select.

## Basic MIDI settings

You can select the type of MIDI messages the QL series console will transmit and receive, the MIDI port that will be used, and the MIDI channel.

### STEP

1. In the Function Access Area, press the **SETUP** button.
2. Press the **MIDI/GPI** button in the center of the **SETUP** screen.
3. Press the **MIDI SETUP** tab in the **MIDI/GPI** screen.
4. Press the port select button for transmission (Tx) or reception (Rx) in the **MIDI SETUP** page.
5. In the **MIDI SETUP** window for port selection, select the port type and port number that will transmit or receive MIDI messages, and press the **OK** button.
6. Press the channel select button in the **MIDI SETUP** page.
7. In the **MIDI SETUP** window for channel selection, select the channel that will transmit or receive MIDI messages, and press the **OK** button.
8. In the **MIDI SETUP** page, turn transmission/reception on or off for each MIDI message.

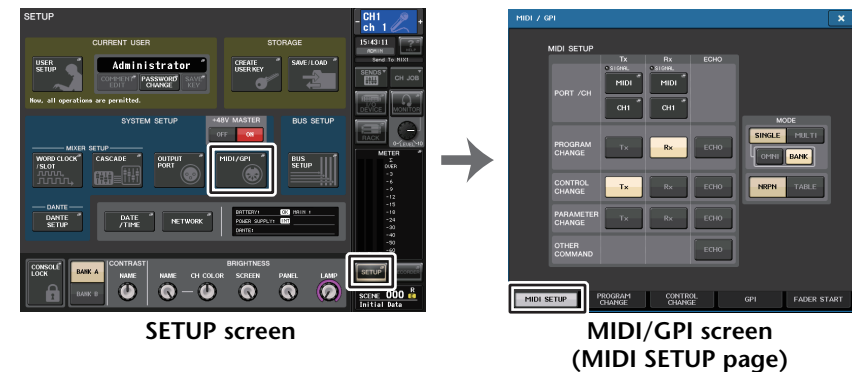

### NOTE

- For details on using Program Change messages, refer to [“Using program changes to recall scenes and library items”](#) on page 141.
- For details on using Control Change messages, refer to [“Using control changes to control parameters”](#) on page 143.

## MIDI/GPI screen (MIDI SETUP page)

You can select the type of MIDI messages that will be transmitted and received, and choose the port that will be used.

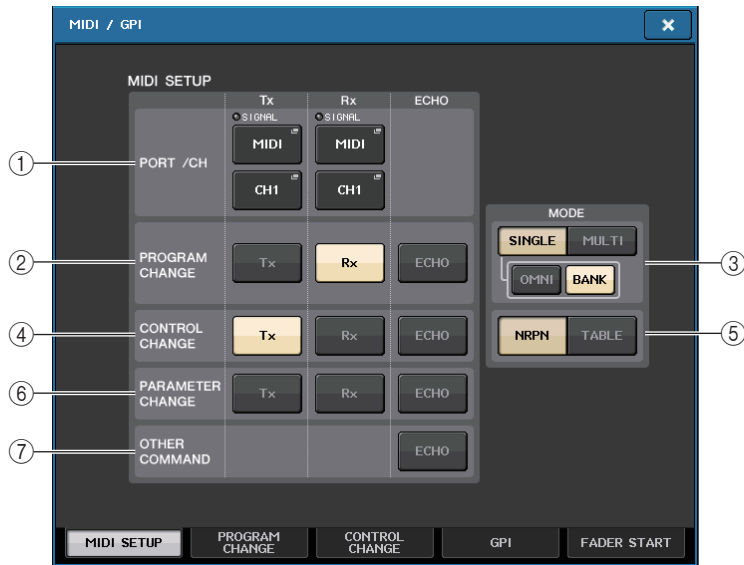

### ① PORT/CH field

Enables you to select the port and MIDI channel that will be used to transmit and receive MIDI messages.

- **Tx PORT/Tx CH**..... Press these buttons to open windows in which you can respectively select a port and MIDI channel to transmit MIDI messages.
- **Rx PORT/Rx CH**..... Press these buttons to open windows in which you can respectively select a port and MIDI channel to receive MIDI messages.

### NOTE

When transmitting or receiving Parameter Changes, the channel number you specify here is used as the device number (a number that identifies the transmitting or receiving unit).

### ② PROGRAM CHANGE field

Enables you to switch MIDI Program Change message transmission and reception on or off.

- **Tx**..... Switches program change transmission on/off.
- **Rx**..... Switches program change reception on/off.
- **ECHO**..... Switches on or off echo output of Program Change messages. (If this function is on, Program Change messages received from an external device will be retransmitted without modification.)

### ③ PROGRAM CHANGE MODE field

Enables you to select the Program Change transmit/receive mode.

- **SINGLE**..... If this button is on, Program Changes will be transmitted and received on a single MIDI channel (Single mode).
- **MULTI**..... If this button is on, program changes will be transmitted/received on multiple MIDI channels (Multi mode).
- **OMNI**..... If this button is on, Program Changes on all MIDI channels will be received in Single mode. Multi mode transmission/reception and Single mode transmission are disabled.
- **BANK**..... If this button is on, Bank Select messages can be transmitted and received in Single mode. (Bank Select messages switch the group of Program Change messages to be used.)

### ④ CONTROL CHANGE field

Enables you to switch MIDI Control Change message transmission and reception on or off.

- **Tx**..... Switches control change transmission on/off.
- **Rx**..... Switches control change reception on/off.
- **ECHO**..... Switches on or off echo output of Control Change messages. (If this function is on, Control Change messages received from an external device will be retransmitted without modification.)

### ⑤ CONTROL CHANGE MODE field

This field enables you to select the Control Change transmission/reception mode.

- **NRPN button**..... If this button is on, the QL mix parameters will be transmitted/received as NRPN messages on one MIDI channel (NRPN mode).
- **TABLE button**..... If this button is on, the QL mix parameters will be transmitted/received as Control Change messages on one MIDI channel (TABLE mode).

### ⑥ PARAMETER CHANGE field

Enables you to turn transmission/reception of SysEx (system exclusive) messages on or off. (These are special messages used to control the parameter of the QL console.)

- **Tx**..... Switches parameter change transmission on/off.
- **Rx**..... Switches parameter change reception on/off.
- **ECHO**..... Switches on or off echo output of Parameter Change messages. (If this function is on, Parameter Change messages received from an external device will be retransmitted without modification.)

### ⑦ OTHER COMMAND field

Switches on or off echo output of other MIDI messages. (If this function is on, other MIDI messages received from an external device will be retransmitted without modification.)

## MIDI SETUP window (for port selection)

Here you can select the port that will be used to transmit and receive MIDI messages. This window appears when you press the port select button for transmission (Tx) or reception (Rx) in the PORT/CH field.

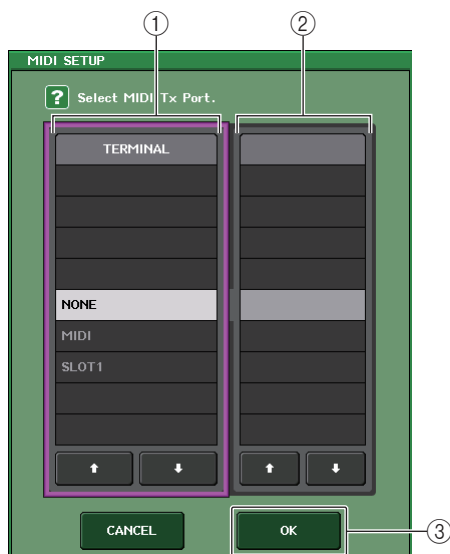

### ① TERMINAL field

Enables you to select the port that will transmit or receive MIDI messages. You can choose from the following items.

NONE	No port will be used.
MIDI	MIDI IN (Rx) and OUT (Tx) connectors on the rear panel
SLOT1	A card that supports serial transmission and is installed in Slot 1 on the rear panel

### ② PORT NO. field

If you select SLOT 1 in the TERMINAL field, choose port number 1–8 in this field. (The number of available ports will vary depending on the card that is installed.) The currently-available card is valid only for port 1.

### ③ OK button

Confirms the settings and closes the window.

## MIDI SETUP window (for channel selection)

This parameter row enables you to specify MIDI Channels for MIDI message transmission and reception. This window appears when you press the channel select button in the PORT/CH field.



### ① CH field

Enables you to select CH1–CH16 as the channel that will transmit or receive MIDI messages.

### ② OK button

Confirms the settings and closes the window.

## Using program changes to recall scenes and library items

The QL series console lets you assign a specific event (scene recall or effect library recall) to each Program Change number, so that when this event is executed on the QL console, a Program Change message of the corresponding number will be transmitted to an external device. Conversely, the corresponding event can be executed when a Program Change message is received from an external device.

### STEP

1. Connect the QL series console to an external device.
2. As described in “Basic MIDI settings” on page 138, select the ports and MIDI channels that will be used to transmit/receive program changes.
3. Press the PROGRAM CHANGE tab in the MIDI/GPI screen.
4. In the PROGRAM CHANGE page, switch Program Change transmission/reception on or off, select transmission/reception mode, and set echo output.
5. To change the event assignment for each program number, press the desired event in the list and select an event type and the recall target.



MIDI/GPI screen  
(PROGRAM CHANGE page)

### NOTE

Assignments to program numbers are maintained as settings for the entire system, rather than for individual scenes.

## MIDI/GPI screen (PROGRAM CHANGE page)

In the PROGRAM CHANGE page, you can specify how Program Changes will be transmitted and received, and choose the event (scene recall or effect library recall) that will be assigned to each program number.

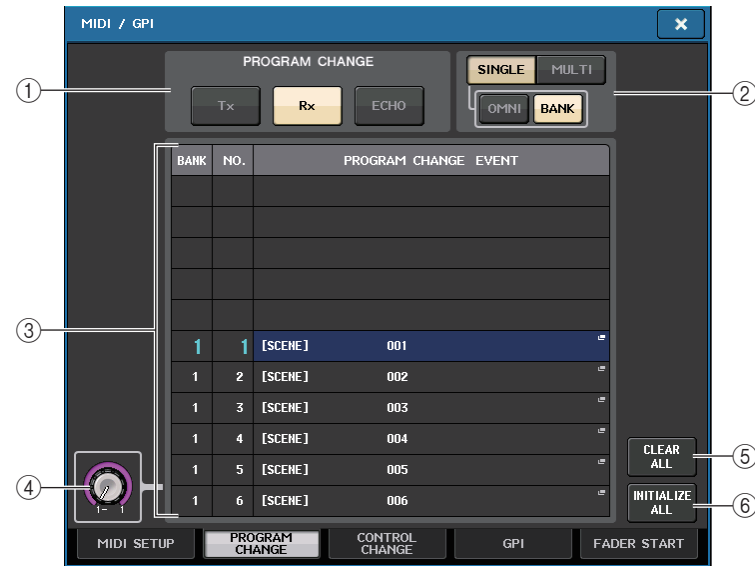

### ① PROGRAM CHANGE field

Switches Program Change transmission and reception on or off. This setting is linked with the PROGRAM CHANGE section of the MIDI SETUP page.

- **Tx** ..... If this is on, the corresponding Program Change messages will be transmitted when events on the list are executed.
- **Rx** ..... If this is on, the corresponding events will be executed when Program Change messages are received.
- **ECHO** ..... If this button is on, Program Change messages received from an external device will be retransmitted without change.

### ② PROGRAM CHANGE MODE field

Enables you to select the Program Change transmit/receive mode. This setting is linked with the PROGRAM CHANGE MODE section of the MIDI SETUP page.

- **Multi mode (when the MULTI button is on):**  
Program changes of all MIDI channels will be transmitted and received. (The transmit/receive channel specified in the MIDI SETUP page will be ignored.) When a Program Change is received, the event assigned to the corresponding MIDI channel and program number in the list will be executed.



When you execute a specific event on a QL series console, the Program Change of the corresponding program number will be transmitted on the MIDI channel shown in the list. (If an event is assigned to more than one program number on multiple MIDI channels/multiple program numbers, only the lowest-numbered program number on each MIDI channel will be transmitted.)

• **Single mode (when the SINGLE button is on):**

Only Program Changes of the transmit (Tx) and receive (Rx) channels specified in the MIDI SETUP page will be transmitted and received. When a program change on the Rx channel is received, the event assigned to that program number of the corresponding channel in the list will be executed.

When you execute a specific event on a QL series console, the Program Change of the corresponding program number will be transmitted on the Tx channel shown in the list. (If an event is assigned to more than one program number on the same channel, the lowest-numbered program number will be transmitted.)

• **When the OMNI button is on in SINGLE mode**

Program changes of all MIDI channels will be received. However, regardless of the MIDI channel that is received, the event assigned to the corresponding program number of the Rx channel will be executed. Turning on the OMNI button will not change the operation for Program Change transmission.

• **When the BANK button is on in SINGLE mode**

The CH indication in the list will change to BANK (bank number), and Bank Select (Control Change #0, #32) and Program Change messages can be transmitted and received. This can be convenient if you want to control more than 128 events on a single MIDI channel.

When Bank Select and then Program Change messages (in that order) are received on the Rx channel, the event assigned to that bank number and program number in the list will be executed.

When you execute a specific event on the QL series console, bank select + program change messages for the bank number and program number assigned to that event will be transmitted on the Tx channel. (If the same event is assigned more than once in the list, the lowest-numbered bank number and program number will be transmitted.)

**NOTE**

- The settings of the OMNI and BANK buttons are ignored in Multi mode.
- If the BANK button is on and only a Program Change on an applicable MIDI channel is received, the last-selected bank number will be used.
- If the BANK button is on, the OMNI button can also be turned on at the same time. In this case, Bank Select and Program Change messages of all MIDI channels will be received.

③ **List**

Shows the event (scene recall or library recall) assigned to each MIDI channel and MIDI Program Change number. The list shows the following items.

- **CH/BANK**.....If “CH” is shown, this column indicates the MIDI channel (1–16) on which Program Changes are transmitted/received. If Program Change transmission and reception is in Single mode and the BANK button is on, this will be labeled “BANK,” and the numerical value in this column will correspond to the bank number.

- **NO**.....Indicates the program number 1–128.
- **PROGRAM CHANGE EVENT**  
.....Indicates the type/number/title of the event assigned to each channel (bank number) or program number. Press an individual event display area to access the MIDI PROGRAM CHANGE window, in which you can select the event that you want to assign.

④ **Scroll knob**

Use the [TOUCH AND TURN] knob to scroll the list up or down.

⑤ **CLEAR ALL button**

Press this button to erase all events from the list.

⑥ **INITIALIZE ALL button**

Press this button to restore all event assignments on the list to their default state.

## MIDI PROGRAM CHANGE window

You can specify the event assigned to each program number. Display this window by pressing the list in the PROGRAM CHANGE page in the MIDI/GPI screen.

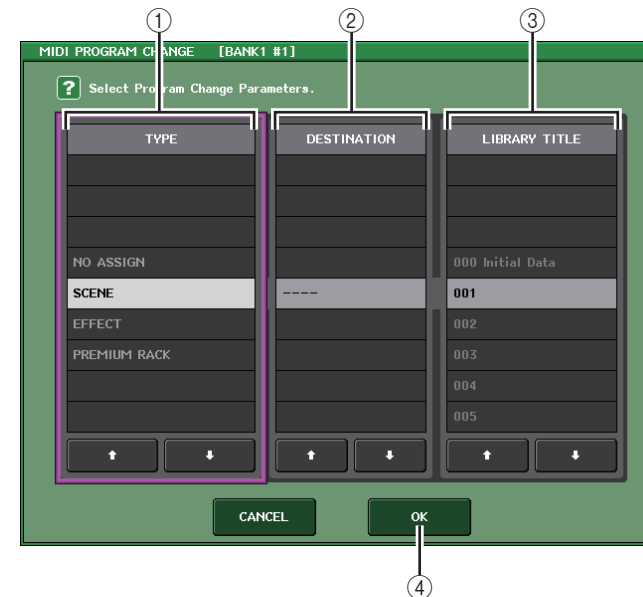

① **TYPE field**

Enables you to select the type of event.

The following table lists the events you can select.

NO ASSIGN	No assignment
SCENE	Scene memory recall operations
EFFECT	Effect library recall operations
PREMIUM RACK	Recall operations for the corresponding Premium Rack library

② **DESTINATION field**

Enables you to select the rack for which you want to recall a library item. If EFFECT or PREMIUM RACK is selected in the TYPE field, the rack number will be shown. If SCENE is selected, this will indicate "--", and no choice is available for this field.

③ **LIBRARY NUMBER/LIBRARY NAME field**

Enables you to select the scene or library item to recall.

If SCENE or EFFECT is selected in the TYPE field, the LIBRARY NAME is shown. If PREMIUM RACK is selected, the LIBRARY NUMBER and LIBRARY NAME are shown.

④ **OK button**

Confirms the settings and closes the window.

## Using control changes to control parameters

You can use MIDI Control Change messages to control specified events (fader/knob operations, [ON] key on/off operations etc.) on the QL series console. This capability can be used to record fader and key operations on a MIDI sequencer or other external device, and play back this data later.

You can use Control Changes to control events in either of the following two ways.

### ■ Using Control Changes

This method uses typical Control Changes (control numbers 1–31, 33–95, 102–119). You can freely assign an event to each control number.

### ■ Using NRPN (Non Registered Parameter Number)

This method uses a special type of Control Change messages called NRPN.

NRPN uses Control Change numbers 99 and 98 to specify the MSB (Most Significant Byte) and LSB (Least Significant Byte) of the parameter number, and subsequently-transmitted Control Change messages of Control Change number 6 (or 6 and 38) to specify the value of that parameter.

The event assigned to each combination of MSB and LSB is pre-defined, and cannot be changed.

#### NOTE

For details on the events assigned to NRPN messages, refer to the QL Data List (End of Manual).

## STEP

1. Connect the QL series console to an external device.
2. As described in “Basic MIDI settings” on page 138, select the ports and MIDI channels that will be used to transmit/receive control changes.
3. Press the CONTROL CHANGE tab in the MIDI/GPI screen.
4. Switch Control Change transmission/reception on or off, select transmission/reception mode, and set echo output.
5. To change the event assignment for each control number, press the desired event in the list and select an event type and the recall target.



MIDI/GPI screen  
(CONTROL CHANGE page)

#### NOTE

Assignments to control numbers are maintained as settings for the entire system, rather than for individual scenes.

## MIDI/GPI screen (CONTROL CHANGE page)

You can specify how Control Changes will be transmitted and received, and specify the event (fader/knob operation, [ON] key on/off operation, etc.) assigned to each control number.



### ① CONTROL CHANGE field

Enables you to switch Control Change transmission/reception on or off, and specify whether Control Changes will be echoed out. This setting is linked with the CONTROL CHANGE field on the MIDI SETUP page.

- **Tx button** ..... Switches control change transmission on/off.
- **Rx button** ..... Switches control change reception on/off.
- **ECHO button** ..... Selects whether incoming control changes will be echoed out from the MIDI transmit port.

### ② CONTROL CHANGE MODE field

This field enables you to select the Control Change transmission/reception mode. This setting is linked with the CONTROL CHANGE MODE field on the MIDI SETUP page.

- **NRPN mode (when the NRPN button is on):**  
Various mix parameters on the QL series console will be transmitted and received on a single MIDI channel as NRPN messages. If you select this mode, the assignments in the list will be ignored.
- **TABLE mode (when the TABLE button is on):**  
Various mix parameters on the QL series console will be transmitted and received on a single MIDI channel as Control Change messages, according to the assignments in the list.

## NOTE

The channel on which Control Changes are transmitted and received is specified by the PORT/CH field on the MIDI SETUP page (page 139).

### ③ List

Shows the event (fader/knob operation, [ON] key on/off operation, etc.) assigned to each control number.

- **NO.** ..... This indicates the control number. You can use control numbers 1–31, 33–95, and 102–119.
- **CONTROL CHANGE EVENT** ..... Indicates and enables you to select the type of event assigned to each control number. When you press an event, the MIDI CONTROL CHANGE window will appear, allowing you to change the control number assignment.

### ④ CLEAR ALL button

Press this button to clear all event assignments on the list.

### ⑤ INITIALIZE ALL button

Press this button to restore all event assignments on the list to their default state.

### ⑥ Scroll knob

Scrolls the contents of the list. You can use the [TOUCH AND TURN] knob to operate this.

## MIDI CONTROL CHANGE window

Display this window by pressing any event in the CONTROL CHANGE page. In this window, you can specify the event assigned to each control number.

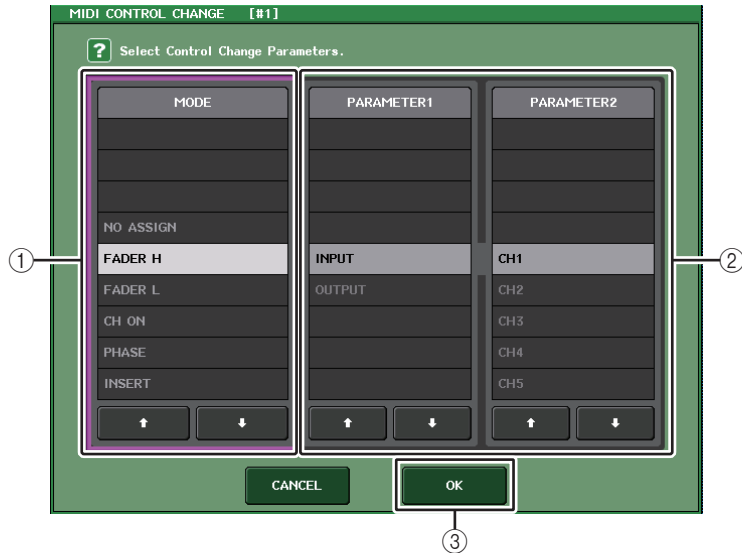

- ① **MODE field**  
Enables you to select the type of event.
- ② **PARAMETER 1/2 field**  
In conjunction with the MODE field, this field specifies the type of event.
- ③ **OK button**  
Confirms the settings and closes the window.

### NOTE

- The list shown is the same for all models of the QL series. For the QL1, the display will indicate “Cannot Assign!” if you specify a parameter that does not exist on that model.
- If NRPN mode is selected as the control change transmission/reception mode, the settings in this window are ignored.
- For details on the events that can be assigned to Control Changes, refer to the QL Data List (End of Manual).

## Using Parameter Changes to control parameters

On the QL series console, you can use a type of system exclusive messages called “Parameter Changes” to control specific events (fader/knob operations, [ON] key on/off operations, system and user settings, etc.) as an alternative to using Control Changes or NRPN messages.

For details on the Parameter Changes that can be transmitted and received, refer to “MIDI Data Format” in the QL Data List (End of Manual).

### STEP

1. Connect the QL series console to an external device.
2. As described in “[Basic MIDI settings](#)” on [page 138](#), select the ports and MIDI channels (device number) that will be used to transmit/receive parameter changes.
3. Use the Tx button and Rx button of the PARAMETER CHANGE field in the MIDI SETUP page to turn on parameter change transmission/reception.

### NOTE

- Parameter changes include a “device number” that specifies the transmitting or receiving device. The transmit (Tx) channel and receive (Rx) channel specified on the MIDI SETUP page are used as the device number.
- Please be aware that if the device number included in the transmitted Parameter Change does not match the device number of the receiving QL console, the message will be ignored.
- Do not turn Parameter Change and Control Change transmission/reception on at the same time. Otherwise, a large amount of data will flood the MIDI port and may cause overflows or other problems.

# Recorder

This chapter explains the functionality and operation of the recorder.

## About the USB memory recorder

The QL series console features a USB memory recorder function that lets you easily record internal audio signals to a USB flash drive, or play back audio files recorded on a USB flash drive.

As the file format for recording, the QL series console supports MP3 (MPEG-1 Audio Layer-3). For playback, it supports MP3 as well as WMA (Windows Media Audio) and AAC (MPEG-4 AAC) files. However, DRM (Digital Rights Management) is not supported.

By using the USB memory recorder, the output from the STEREO bus or a MIX bus can be recorded to a USB flash drive, or background music or sound effects saved on the USB flash drive can be played back via an assigned input channel.

### ■ Signal flow for the USB memory recorder

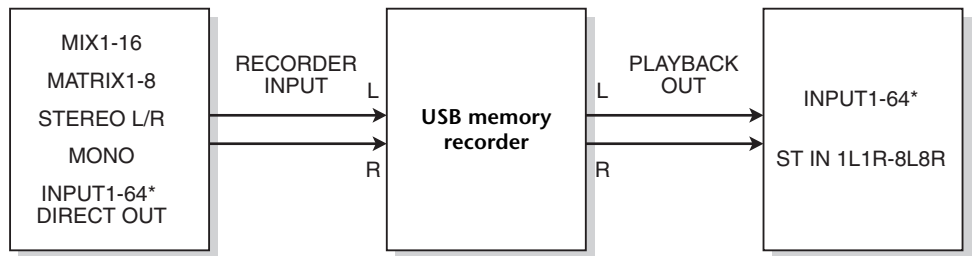

\* QL1: INPUT1-32

#### NOTE

- Recording and playback cannot be done simultaneously.
- The signal being recorded cannot be input to an INPUT channel.

## Assigning channels to the input/output of the recorder

Follow the steps below to patch the desired channels to the input and output of the USB memory recorder. You can patch any desired output channel or the direct output of an INPUT channel to the recorder input, and you can patch the recorder output to any desired input channel.

### STEP

1. In the Function Access Area, press the RECORDER button.
2. Press the USB tab in the RECORDER screen.
3. Press the RECORDER INPUT L or R button.
4. Use the category list and the port select buttons in the CH SELECT window to select the channel that you want to patch to the USB memory recorder input.
5. When you have finished assigning the channel, press the CLOSE button.
6. Assign a channel to the other input in the same way.
7. Press the PLAYBACK OUTPUT L or R button.
8. Use the category list and the channel select buttons in the CH SELECT window to select the channel that you want to patch to the USB memory recorder output.
9. When you have finished assigning the channel, press the CLOSE button.
10. Assign a channel to the other output in the same way.



RECORDER screen

#### NOTE

- The USB memory recorder always records and plays back in stereo. If you want to record in monaural, with the same signal for left and right, you must assign both of the recorder inputs to the same channel.
- You can patch multiple channels to the recorder output.
- In steps 4 and 8, if you select a channel to which another port is already patched, a dialog box will ask you to confirm the patch change. Press the OK button in the dialog box.
- In the case of QL1, channels that do not exist on the model will not be shown.

## RECORDER screen (when selecting the USB tab)

In this screen you can assign signals to the input and output of the USB memory recorder, and perform recording and playback operations.



### ① RECORDER INPUT L/R buttons

Press these buttons to open the CH SELECT window, in which you can select the signals patched to the recorder's L/R input channels.

### ② RECORDER INPUT GAIN knob

Sets the level of the signal input to the recorder.

### ③ RECORDER INPUT CUE button

When this button is turned on, you can monitor the signal input to the recorder.

#### NOTE

You cannot turn on this button and the PLAYBACK OUTPUT CUE button simultaneously.

### ④ Meters

Indicate the level of the signals input to the recorder.

### ⑤ PLAYBACK OUTPUT L/R buttons

Press these buttons to open the CH SELECT window, in which you can select the signals patched to the recorder's L/R output channels for playback.

### ⑥ PLAYBACK OUTPUT GAIN knob

Sets the level of the signal output to the recorder.

### ⑦ PLAYBACK OUTPUT CUE button

Press this button to monitor the signal output from the recorder.

#### NOTE

You cannot turn on this button and the RECORDER INPUT CUE button simultaneously.

### ⑧ Meters

Indicate the level of the signals output to the recorder.

## CH SELECT window

Display this window by pressing the RECORDER INPUT L or R button or the PLAYBACK OUTPUT L or R button.

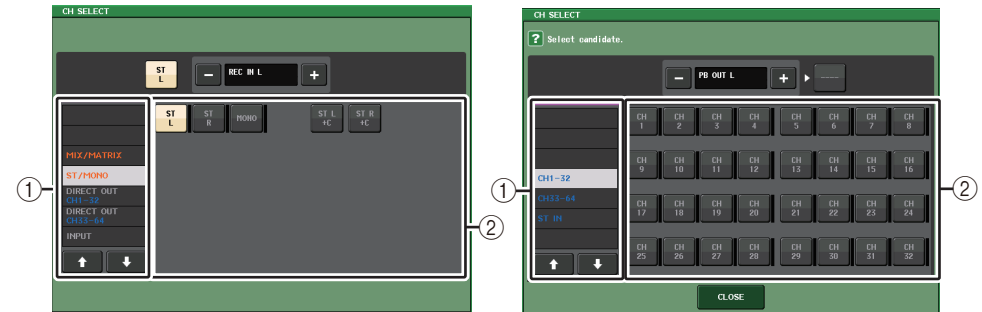

### ① Category List

Enables you to select the type of channel.

### ② Channel select button

Select the channels that will be patched to the USB memory recorder's inputs and outputs. The channels that can be patched at input or output are different.

#### Channels that can be patched to the recorder's inputs

- MIX 1–16..... MIX channels 1–16
- MTRX 1–8..... MATRIX channels 1–8
- ST L/R..... STEREO channel L/R
- ST L+C..... STEREO channel L mixed with the MONO(C) channel
- ST R+C..... STEREO channel R mixed with the MONO(C) channel
- MONO..... MONO channel
- CH1–64 (QL5), CH1–32 (QL1)
  - ..... Direct output of an INPUT channel 1–64 (QL5) or INPUT channel 1–32 (QL1)
- INPUT..... INPUT1–32 (QL1: INPUT1–16)
- SLOT1 IN..... SLOT1(1)–SLOT1(16)
- SLOT2 IN..... SLOT2(1)–SLOT2(16)
- DANTE1–32..... DANTE1–DANTE32
- DANTE33–64..... DANTE33–DANTE64 (QL5 only)

Channels that can be patched to the recorder's outputs

- CH1–64 (QL5), CH1–32 (QL1)  
..... INPUT channel 1–64 (QL5) or INPUT channel 1–32 (QL1)
- STIN 1L/1R-STIN 8L/8R  
..... ST IN channels 1–8L/R

## Recording audio to a USB flash drive

You can record the signal of the desired output channels as an audio file (MP3) onto the USB flash drive inserted in the USB connector located to the right of the display.

### STEP

1. Refer to “Assigning channels to the input/output of the recorder” on page 146 to assign channels to the input/output of the recorder.
2. Connect a USB flash drive with sufficient free capacity to the USB connector.
3. To monitor the signal being recorded, raise the fader for the channel(s) that are patched to the input of the recorder.
4. Press the REC RATE button in the lower right of the RECORDER screen, then select the bit rate for the audio file that will be recorded.
5. Press the REC (●) button located at the bottom of the screen.
6. To start recording, press the PLAY/PAUSE (▶||) button in the lower part of the screen.
7. To stop recording, press the STOP (■) button.
8. To audition the recorded content, proceed as follows.
  - 8-1. Press the PLAY/PAUSE (▶||) button to play back the recording.
  - 8-2. To stop playback, press the STOP (■) button.

### NOTE

- The FREE SIZE field indicates the amount of free capacity in the USB flash drive.
- The signal being recorded will not be output from the recorder output jacks (PLAYBACK OUT).
- The level meter on the RECORDER screen shows the signal level before and after the recorder. If necessary, use the GAIN knob in the RECORDER INPUT field to adjust the input level to the recorder. Operating the GAIN knob will not affect the level of the signal being output to other ports from the corresponding output channel.
- In the default state, the recorded audio file will be saved in the SONGS folder within the YPE folder in the USB flash drive. However, you may also specify a folder of a level below the SONGS folder.
- The recorded file will be given a default title and file name. You can change this later.

## RECORDER screen (when selecting the USB tab)



### TRANSPORT field

This field enables you to control recording and playback of a song.

#### ① Current song

Indicates the currently-selected song's track number, title and artist name. The following indicators will appear during playback or recording.

#### Playing



#### Recording



#### ② Elapsed time display

Indicates the elapsed playback time of the current song during playback, and the elapsed recording time during recording.

#### ③ Remaining time display

During playback, this indicates the remaining playback time of the current song.

#### ④ Current song format

Indicates the file format information for the current song (the file being recorded).



### ⑤ REC RATE button

Switches the recording rate.

You can choose 96 kbps, 128 kbps, or 192 kbps. Higher bit rates will improve the audio quality, but will increase the size of the data.

#### NOTE

The word clock rate at which the QL series console is currently operating will automatically be selected as the sampling rate for the audio file.

### ⑥ Display switch buttons

Switches between displaying and hiding the RECORDER INPUT/PLAYBACK OUTPUT fields at the bottom of the song list.

### ⑦ REW button

Moves the playback point to the beginning of the current song and stops playback. If the playback point is already at the beginning, the point will move to the beginning of the preceding song that has been selected for playback.

If the playback point is not at the beginning of the current song, holding down this button for two seconds or longer will rewind the playback point.

If you operate this button during playback, playback will resume from the point at which the button was released.

### ⑧ STOP button

The recorder will change from play/record/recording-standby mode to stop mode.

### ⑨ PLAY button

Changes the recorder mode as follows.

Stop mode → Playback mode, then starts playback from the beginning of the current song.

Playback mode → Playback-pause mode

Playback pause mode → Playback mode, then starts playback from the paused point.

Recording standby mode → Recording mode

Recording mode → Recording-pause mode

Recording-pause mode → Recording mode, then starts recording from the paused point.

### ⑩ FF button

Moves the playback point to the beginning of the next song that is marked with a PLAY check symbol.

If you hold down this button for two seconds or longer, fast-forward will occur.

If you operate this button during playback, playback will resume from the point at which the button was released.

### ⑪ REC button

Places the recorder in recording standby mode.

The pause indicator of the PLAY/PAUSE (▶ ||) button will light.

#### NOTE

You can also assign the function of each button to a USER DEFINED key (page 169).

## ■ Directory structure of a USB flash drive

When you connect a USB flash drive to the USB connector, a YPE folder and a SONGS folder within that YPE folder will be created automatically in the root directory of the USB flash drive.

The files created by recording operations will be saved in the above SONGS folder, or in the currently-selected folder below that level.

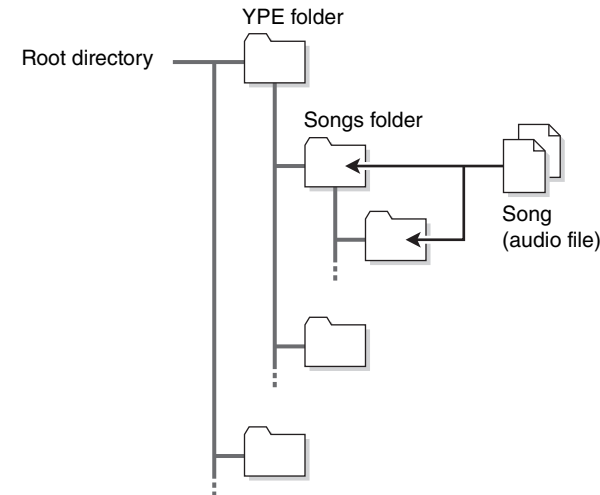

## Playing back audio files from a USB flash drive

You can play back audio files that have been saved on your USB flash drive. In addition to files that were recorded on the QL series console, you can also play files that were copied from your computer to the USB flash drive.

The three types of file format that can be played are MP3 (MPEG-1 Audio Layer-3), WMA (Windows Media Audio), and AAC (MPEG-4 AAC). The playable sampling rates are 44.1 kHz and 48 kHz. The supported bit rate ranges from 64 kbps to 320 kbps.

### NOTE

- If you want to play back an audio file, you must save it in the SONGS folder within the YPE folder, or in a folder you have created below the SONGS folder. Files located in other folders and files of unsupported formats will not be recognized.
- The QL series console can recognize a file name that is a maximum of 64 single-byte characters. If the file name is longer than this, the desired file may not play correctly.
- A maximum of 300 songs can be managed in a single directory. A maximum of 64 subdirectories can be managed.

### STEP

1. Connect a USB flash drive that contains the audio files to the USB connector.
2. In the Function Access Area, press the RECORDER button.
3. You can use the change directory icon in the RECORDER screen and the folder icon in the No. field to view a content list of the folder that includes the desired file.
4. Use the [TOUCH AND TURN] knob or press the on-screen file name to select the desired file.
5. Press a button in the PLAY MODE field to select the playback mode.
6. If you turned on the REPEAT button in step 5, press the PLAY checkmark for the song you want to play.
7. Press the PLAY/PAUSE (▶ ||) button to play back the song.
8. To stop playback, press the STOP (■) button.

### NOTE

- Even if the sampling rate at which the QL series console is operating differs from the sampling rate of the audio file being played, the SRC (Sampling Rate Converter) function will automatically convert the rate so that the file will be played back correctly.
- If the REPEAT button is on, playback will continue until you stop playback.

## RECORDER screen

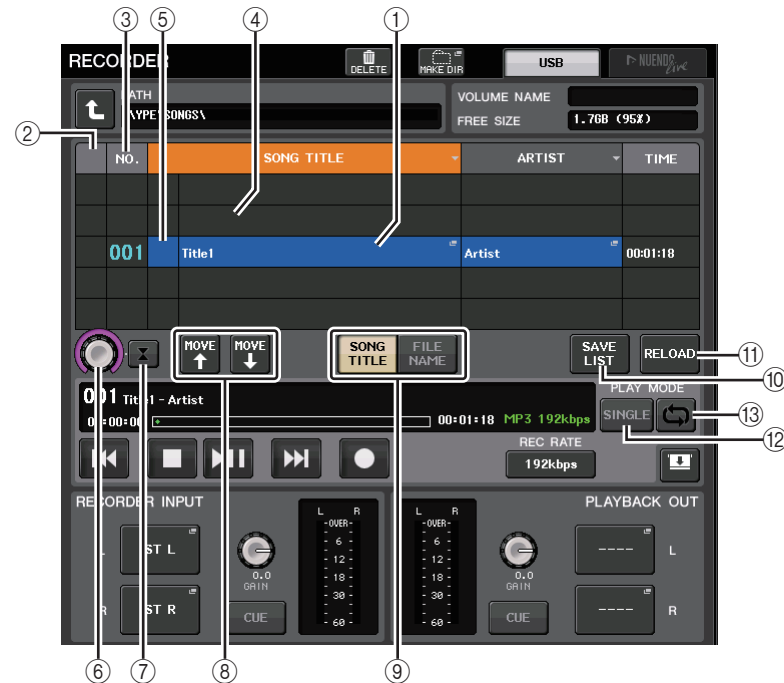

### ■ Title list

This list enables you to perform operations related to the songs and directories that are saved on the USB flash drive.

- ① **Selected song**  
The currently selected song will appear in a blue frame.
- ② **Status indicator**  
Displays a symbol to indicate whether the currently-selected file is playing or paused.  
▶: Playing, ||: Paused
- ③ **Track number**  
Indicates the file number in the title list.

**④ Sub-directory**

Indicates each song's track number, the name of upper level directory, and whether a sub-directory exists (in the case that the directory has been selected).

- **Upper level** ..... Press this to move up to the directory that is one level higher than the current one.



- **Sub-directory** ..... Press this to move to that sub-directory.

**NOTE**

- If you switch folders, that folder will be selected as the recording destination.
- The folders that can be selected are restricted to the SONGS folder inside the YPE folder, and folders located below the SONGS folder.

**⑤ PLAY check symbol**

Enables you to select multiple files that will be played back consecutively.

**⑥ SELECT knob**

Use the [TOUCH AND TURN] knob to select a song.

**⑦ NOW PLAYING button**

Press this button to always select the currently-playing song on the list.

**⑧ MOVE UP/MOVE DOWN buttons**

Change the order of the selected song in the list.

**⑨ Display switch buttons**

Switch the list between the SONG TITLE display and the FILE NAME display.

**⑩ SAVE LIST button**

Saves the order of the current title list and PLAY check symbol settings as a playlist.

**⑪ RELOAD button**

Loads the playlist that was saved most recently. Use this button to revert the current playlist you are editing back to the previous state.

**■ PLAY MODE field**

Sets the playback method of the currently selected song.

**⑫ SINGLE button**

If this button is on, the recorder will stop after playback of the current song is complete. If this button is off, the recorder will play the next song on the list after playback of the current song is complete.

**⑬ REPEAT button**

If this button is on, after playback of the current song is complete, the recorder will play the first song on the list that is marked with a PLAY check symbol (unless there are no subsequent songs that are marked with a PLAY check symbol).

If this button is off, the recorder will stop after playback of the current song is complete (unless there are no subsequent songs that are marked with a PLAY check symbol). One of the following playback methods is selected according to the on/off settings of the SINGLE button and the REPEAT button.

SINGLE button	REPEAT button	Mode
On	On	The currently-selected song will play repeatedly until you stop playback.
On	Off	The currently-selected song will play once and then stop.
Off	On	Songs with the PLAY checkmark selected are played in order, starting with the currently-selected song, and then they are played again from the first song in the title list. The currently-selected song will play repeatedly until you stop playback.
Off	Off	Songs with the PLAY checkmark selected are played in order, starting with the currently-selected song. After the final song in the title list is played, playback stops.

## Editing the title list

You can change the order of the audio files shown in the title list, and edit the titles or artist names.

**STEP**

1. Connect a USB flash drive containing audio files to the USB connector.
2. In the Function Access Area, press the RECORDER button.
3. Press the No. button and the change directory icon in the RECORDER screen to view a list of the contents of the folder that includes the desired file.
4. If you want to edit a title in the title list, press the SONG TITLE/FILE NAME EDIT button. If you want to edit the artist name, press the ARTIST EDIT button.
5. Edit the title or artist name, and press the OK button.
6. If necessary, use the SONG TITLE/FILE NAME SORT button, ARTIST SORT button, and MOVE UP/MOVE DOWN buttons on screen to change the order of the title list.
7. When editing is complete, press the SAVE LIST button to save the changes.

**NOTE**

- If the title or artist name contains characters that cannot be displayed, these characters will be converted into □ for display.
- The title and the artist name can be edited only for MP3 format audio files.

## RECORDER screen (when selecting the USB tab)

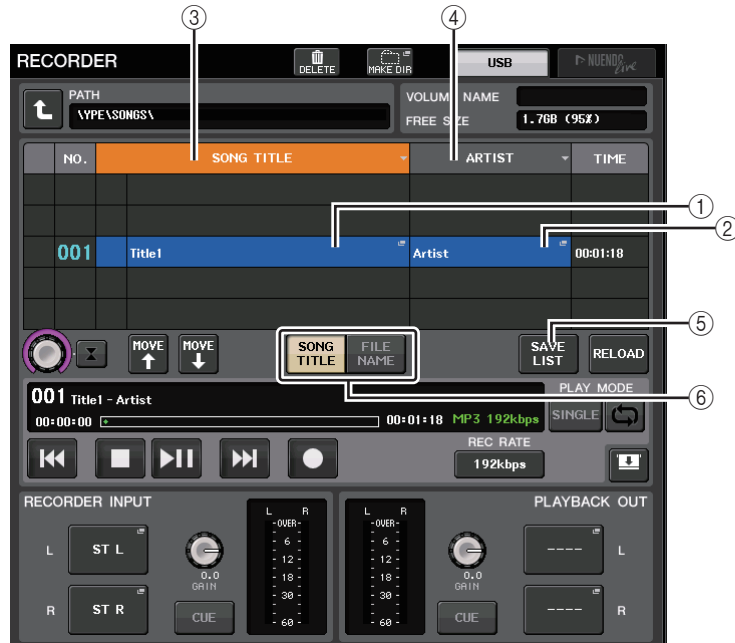

### ① SONG TITLE/FILE NAME EDIT button

Enables you to edit the title of the song selected in the list.

### ② ARTIST EDIT button

Enables you to edit the artist name of the song selected in the list.

### NOTE

A maximum of 128 single-byte characters (64 double-byte characters) can be input for both the title and for the artist name. If the title cannot be shown completely, the text will scroll horizontally.

### ③ SONG TITLE/FILE NAME SORT button

Sorts the list in alphabetical order of the title.

### ④ ARTIST SORT button

Sorts the list in alphabetical order of the artist name.

### ⑤ SAVE LIST button

Saves the order of the current title list and PLAY check symbol settings as a playlist on the USB flash drive.

### ⑥ SONG TITLE/FILE NAME button

Enables you to select either song title or file name to be displayed in the SONG TITLE/FILE NAME field.

## Recording or playing back using a computer DAW

If you plan to add DAW software, such as Steinberg Nuendo, to an audio network that includes a QL console, you must use Dante Virtual Soundcard (DVS) software. DVS works as an audio interface, making it possible to transmit signals between a DAW and an audio network (that includes a QL series console and I/O devices). In this way, you will be able to make multi-track recordings of live performances or use live recordings that were made a day earlier for a virtual sound check.

This section explains the steps required when adding DAW software to an audio network.

### Required devices and software

- QL series
- A computer (Windows or Mac) equipped with an Ethernet port that supports a Giga-bit Ethernet (GbE) network; DAW software
- A GbE-compatible network switch
- CAT5e cable
- Dante Virtual Soundcard driver software or Dante Accelerator card
- Dante Controller control software

### NOTE

- You must have a license ID to use Dante Virtual Soundcard. A sheet with the DVS token needed to acquire the license ID is included in the QL unit package.
- The latest information about the Dante Virtual Soundcard and the Dante Controller is available at the following website:  
<http://www.yamahaproaudio.com/>

## Word clock settings

In a Dante network, the master device supplies accurate word clock to other devices on the network. If the master device is removed from the network or breaks down, another device will automatically take over as the clock master.

To make this setting, in the Function Access Area, press the SETUP button, then the WORD CLOCK/SLOT button to access the WORD CLOCK/SLOT window.

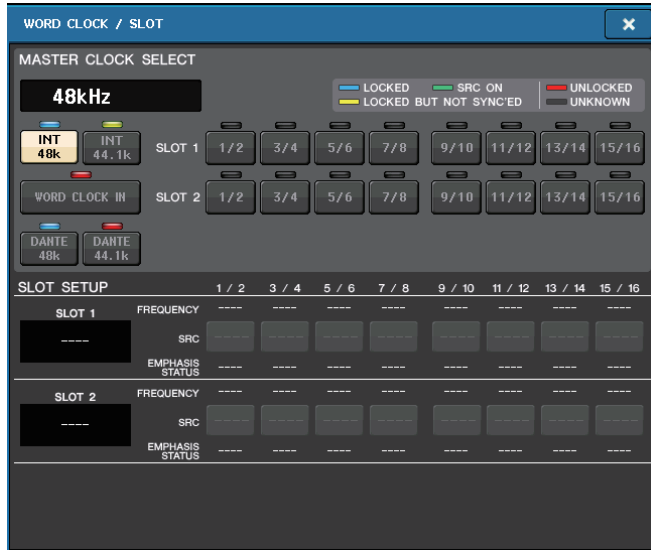

## Setting up Dante Virtual Soundcard

Install Dante Virtual Soundcard (DVS) and Dante Controller in the computer that you want to use for audio recording. Make the following settings before turning DVS on.

- Connect the GbE-compatible network port of the computer to a GbE-compatible network switch.
- Configure the computer to obtain an IP address automatically (this is the default setting).
- Set the audio format. (Example: 48kHz, 24 bit)
- Set the Dante latency. (Use a high setting to ensure stability when using multiple channels.)
- In the Advanced settings, select the number of channels to be used for recording and playback (the default is 8 x 8).



### NOTE

Please refer to the Dante Virtual Soundcard User's Guide for more information on ASIO settings (Windows).

## Dante Accelerator settings

After mounting a Dante Accelerator card on the computer, install the Dante Accelerator Driver and make the following settings. For information about how to install the driver, refer to the Installation Guide included with the driver.

- Use a network cable to connect the Dante jack on the Dante Accelerator card to the Dante network, and then connect the computer's network port to the same network.
- Configure the computer to obtain an IP address automatically (this is the default setting).

### NOTE

For more information about selecting a computer for remote control from a QL series console, refer to "When setup method selection button = SPECIFIED IP ADDRESS" in "Specifying DVS or Dante Accelerator" on page 157.

## Setting up Dante Controller

Connect the network port of the computer to a GbE-compatible network switch. Configure the computer to obtain an IP address automatically (this is the default setting).

The following settings can be made via Dante Controller.

- For multi-track recording, patch audio signals from the I/O device to DVS or DANTE-ACCEL.
- For virtual sound check: Patch audio signals in such a way that they will be output from the computer to the Dante audio network, then routed to the channels on the QL console (page 127).

The following example shows Dante Controller settings for when channels 1–16 of an I/O device are patched to DVS.

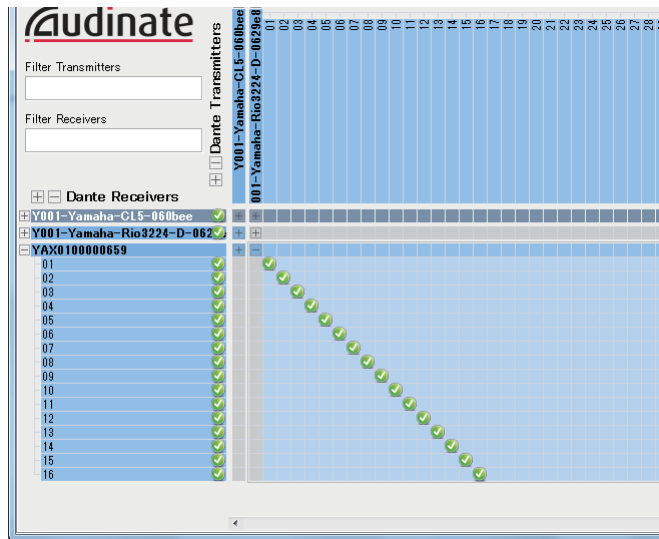

In this case, you'll need to switch the DANTE INPUT PATCH settings of the QL series console depending on whether you're performing multitrack recording or multitrack playback. If you've saved these different sets of settings in the DANTE INPUT PATCH LIBRARY (page 128), you'll be able to switch between them conveniently.

### NOTE

Please refer to the Dante Controller manual for more information about operations and settings of the Dante Controller.

## Setting up DAW software

You must make driver settings in your DAW software. In the device setting window, select “Dante Virtual Soundcard-ASIO” (for a Windows PC) or “Dante” (for Mac) as the sound card (or audio driver) used for input/output.

Some DAW software may require internal patching for the driver and the DAW software. For more information, refer to the DAW software manual.

### ■ Setting up Nuendo Live

When you start up Nuendo Live and create a new project, tracks corresponding to the number of channels specified in DVS will be created automatically, and the channel names and colors from the QL series console will automatically be assigned as each track name.

Make the following settings in Nuendo Live.

- Settings button → Audio System, and select DVS or Dante Accelerator as the driver.

## Audio recording and playback

After you have made driver settings in your DAW software, you can record and play back audio.

For multi-track recording, set the input ports for the tracks of the DAW software to the ports that receive audio signals from the I/O devices.

For a virtual sound check, you must route recorded audio signals to the input channels on the QL console. To do so, patch the signals so that they will be output from the DAW software to DANTE 1–64 on the QL console (DANTE 1–32 for the QL1). It may be convenient for you later if you store two sets of the DANTE INPUT PATCH settings in the library: one set for routing audio signals from the I/O devices, and another set for routing audio signals from DAW software. In this way, you will be able to switch between patch settings without starting Dante Controller. In addition, you will be able to patch a specific channel (such as a vocal) to the I/O device to monitor during a virtual sound check.

## Using the QL console with Nuendo Live

The QL series consoles can operate in an integrated manner with Steinberg's Nuendo Live DAW software.

The “Yamaha Console Extension” software which integrates the QL series and Nuendo Live can be installed in your computer, allowing you to operate Nuendo Live from the QL series console to easily perform multi-track recording operations.

This section explains how to operate Nuendo Live from the QL series console.

### Preparing the project

Refer to “Recording or playing back using a computer DAW” on page 152 to make the following settings.

- Settings for Dante Virtual Soundcard or Dante Accelerator
- Setting up Dante Controller
- Setting up Nuendo Live

### Recording into a project

#### STEP

1. In the Function Access Area, press the RECORDER button.
2. Press the Nuendo Live tab in the upper right of the RECORDER screen.
3. Press the EASY RECORDING button to start recording.
4. When you finish recording, press the record lock button and then press the STOP button.



RECORDER screen  
(when selecting the Nuendo Live tab)

### RECORDER screen (when selecting the Nuendo Live tab)



- ① **Nuendo meter display field**  
This shows the channel levels of Nuendo Live.
- ② **PEAK CLEAR button**  
Clears the peak levels indicated by the peak hold function.
- ③ **Marker list field**  
Lists the marker information recorded in the current Nuendo Live project. The markers can be selected by pressing the on-screen list or by using the [TOUCH AND TURN] knob.
- ④ **Nuendo Live SETUP button**  
Specify the device that the console will use for communication when working with Nuendo Live (page 156).
- ⑤ **DANTE INPUT PATCH button**  
Press this to access the DANTE INPUT PATCH window (page 128).
- ⑥ **Location information display**  
This displays information for the current location of the Nuendo Live project. You can press the button at the right to switch the time display format.



## ■ Transport field

Here you can operate the transport of Nuendo Live.

- ⑦ **GO TO PROJECT START button**  
Returns the location to the start of the project.
- ⑧ **GO TO PREVIOUS MARKER button**  
Returns the location to the previous marker.
- ⑨ **GO TO NEXT MARKER button**  
Advances the location to the next marker.
- ⑩ **GO TO PROJECT END button**  
Advances the location to the end of the project.
- ⑪ **CYCLE button**  
Turns repeat on/off for the project.
- ⑫ **STOP button**  
Stops playback/recording of the project.
- ⑬ **PLAY button**  
Starts playback of the project.
- ⑭ **RECORD button**  
Starts/stops recording of the project.
- ⑮ **EASY RECORDING button**  
Immediately starts recording on all tracks.  
When you press this, the location will move to the last-recorded position, all tracks will be set to record mode, recording will begin, the record panel will be displayed, and the panel will be locked. The recording will be started retrospectively.  
(Initial setting: 10 seconds)
- ⑯ **Record lock button**  
Turns recording status lock on/off. This prevents recording from being accidentally stopped during recording.
- ⑰ **DVS information display**  
Shows the device label of the selected DVS.
- ⑱ **ADD MARKER button**  
Adds a marker to the project at the current location.
- ⑲ **RECALL LINK button**  
Specifies whether a marker will be created when you recall a scene. If this function is turned on, the button will be lit.

### NOTE

Transport functions can also be controlled from USER DEFINED keys ([page 169](#)).

## Specifying DVS or Dante Accelerator

Before you proceed, use DANTE SETUP to specify the I/O devices that will be mounted. For details, refer to “[Mounting an I/O device on the Dante audio network](#)” on [page 197](#).

### STEP

1. In the Nuendo Live screen, press the NUENDO Live SETUP button.
2. In the NUENDO LIVE SETUP window, press the setting method select button.
3. Use the [TOUCH AND TURN] knob to make settings.
4. When you have finished making settings, press the OK button to close the window.

### NOTE

- You can specify either DVS or Dante Accelerator in the NUENDO LIVE SETUP window.
- However, do not select the same DVS or Dante Accelerator from multiple QL series consoles.

## NUENDO LIVE SETUP window

In this window, specify the device that the console will use for communication when working with Nuendo Live.



### ① Setup method select buttons

Choose one of the following methods by which to specify DVS or Dante Accelerator.

- **NO ASSIGN** ..... Not assigned
- **DVS** ..... Select a DVS from the device list
- **SPECIFIED IP ADDRESS** .. When using Dante Accelerator, specify the IP address of the computer

### ■ When setup method selection button = DVS

To choose from a list of the I/O devices on the Dante audio network, press the DVS button to display the DEVICE LIST field.

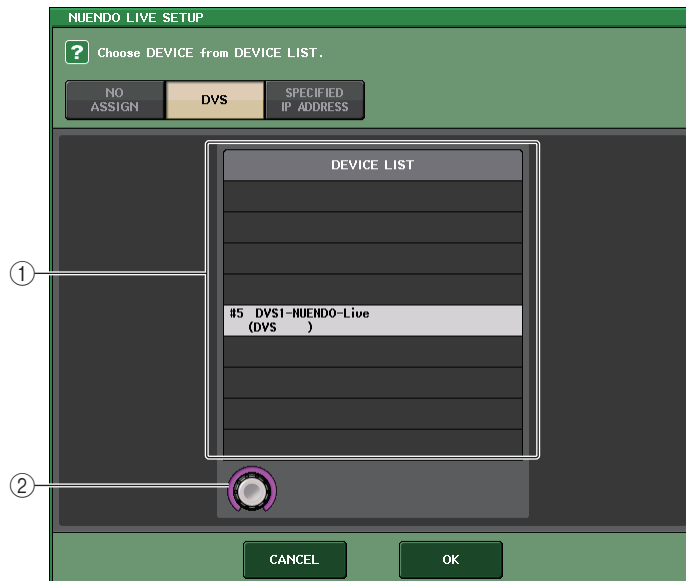

### ① DEVICE LIST

Shows a list of the I/O devices on the Dante audio network. From the list, choose the DVS that you want to use with Nuendo Live.

### ② DEVICE LIST select knob

Use the [TOUCH AND TURN] knob to select the DVS to switch to.

### ■ When setup method selection button = SPECIFIED IP ADDRESS

When using Dante Accelerator, specify the IP address of the computer in the SPECIFIED IP ADDRESS field. Since the IP address of Dante Accelerator will differ from the IP address used by Yamaha Console Extension, you must specify the IP address manually.

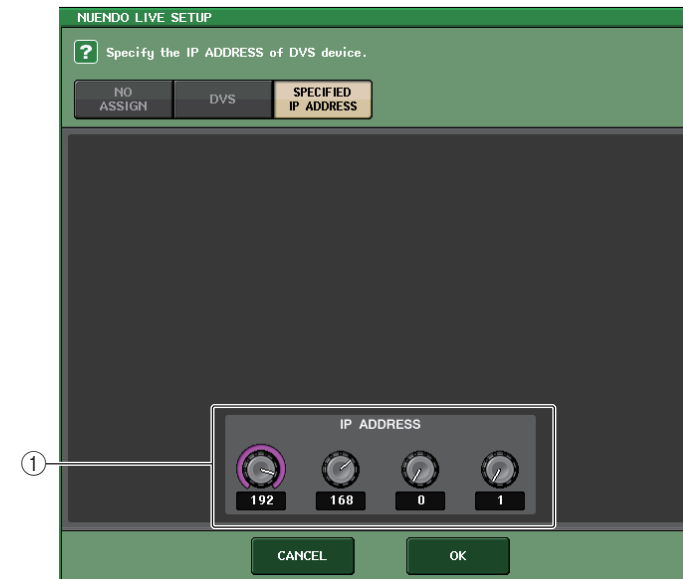

### ① IP ADDRESS knobs

Use the [TOUCH AND TURN] knob to specify an IP address.

### NOTE

- As the IP address, specify the IP address of the computer that is running Nuendo Live.
- Set the address of that computer in the range of 169.254.0.0–169.254.255.255, and set the subnet mask as 255.255.0.0.
- For the computer in which Dante Accelerator is installed, the Dante port of Dante Accelerator as well as the Ethernet port of the computer must both be connected to the same network. Refer to the illustration below.

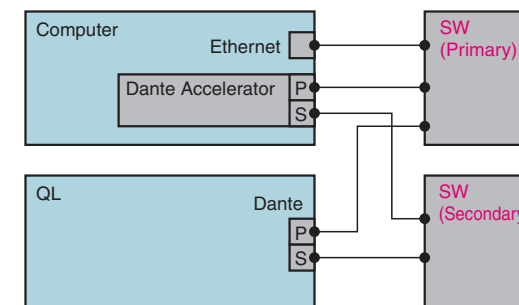

**NOTE**

- Depending on the firmware version, Dante Accelerator might not support redundant networking. Refer to the following website to check whether your version of the Dante Accelerator firmware supports redundant networking.  
<http://www.yamahaproaudio.com/>

## Playing a multi-track project

**STEP**

- Press the DANTE INPUT PATCH button in the RECORDER screen (Nuendo Live page).
- In the DANTE INPUT PATCH window, press the PORT SELECT button for the port to which you want to assign the signal from Nuendo Live.
- In the list at the left of the PORT SELECT window, select the DVS you're using with Nuendo Live, and select the port you want to assign it to.
- Press the + button located in the upper part of the window to switch the port, and assign a DVS port to it in the same way.
- When you have finished making settings, press the CLOSE button to exit the window.
- Press the "X" symbol in the upper right of the DANTE INPUT PATCH window to close it.
- In the Nuendo Live screen, press the START button.
- Operate the channels so that sound is output.
- To stop playback, press the STOP button.



RECORDER screen  
(when selecting the Nuendo Live tab)



DANTE INPUT PATCH window



PORT SELECT window

**NOTE**

If you save the DANTE INPUT PATCH settings in a library, the settings of the QL series console can be switched conveniently ([page 128](#)).

# Setup

## About the SETUP screen

The SETUP screen enables you to set various parameters that apply to the entire QL console. To access the SETUP screen, press the SETUP button in the Function Access Area. The screen contains the following items.

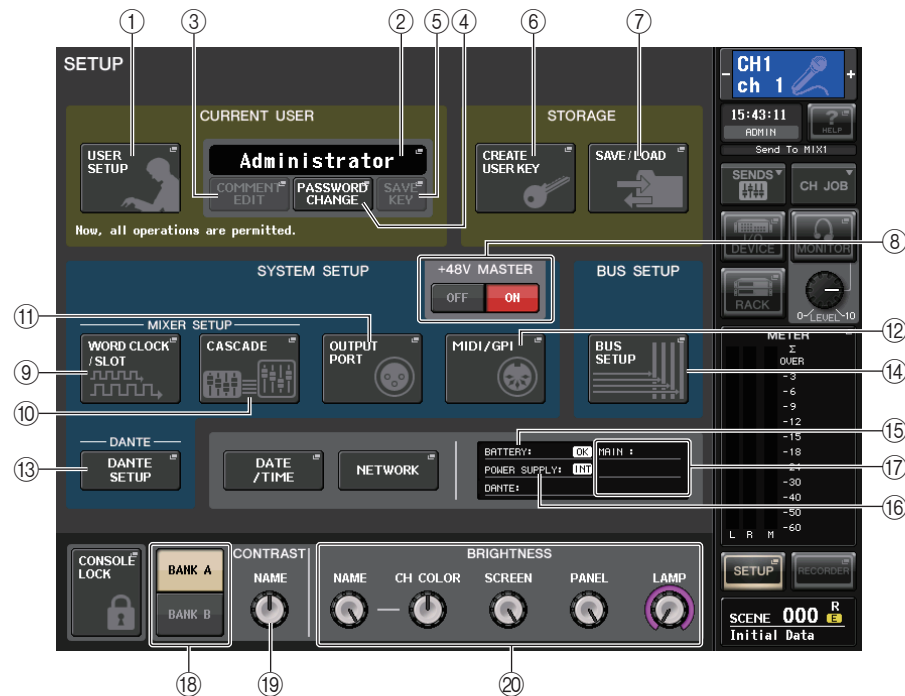

### ■ CURRENT USER field

This field enables you to make various user-related settings.

- ① **USER SETUP button**  
Press this button to open the USER SETUP window, in which you can make various settings for each user.
- ② **CURRENT USER button**  
Press this button to open the LOG IN window, in which you can switch log-in users.
- ③ **COMMENT EDIT button**  
Press this button to open the COMMENT EDIT window, in which you can enter comments that will be displayed in the comment area (●).

- ④ **PASSWORD CHANGE button**  
Press this button to open the PASSWORD CHANGE window, in which you can change the password.
- ⑤ **SAVE KEY button**  
Press this button to open the SAVE KEY window, in which you can overwrite (save) the user authentication key ([page 165](#)).

### ■ STORAGE field

This field enables you to create, save, or load a user authentication key.

- ⑥ **CREATE USER KEY button**  
Press this button to open the CREATE USER KEY window, in which you can create a new user authentication key.
- ⑦ **SAVE/LOAD button**  
Press this button to open the SAVE/LOAD window, in which you can save or load user authentication keys and console files.

### ■ SYSTEM SETUP field

This field enables you to make various settings that globally apply to the QL series console.

- ⑧ **+48V MASTER button**  
Switches the console's master +48V master phantom power on or off. When this button is off, +48V phantom power for all the head amps turns off.

#### NOTE

If this button is off, phantom power will not be supplied even if the +48V button of each channel is on.

- ⑨ **WORD CLOCK/SLOT button**  
Press this button to open the WORD CLOCK/SLOT window, in which you can make word clock settings and various settings for each slot.
- ⑩ **CASCADE button**  
Press this button to open the CASCADE window, in which you can make patch settings for cascade connections.
- ⑪ **OUTPUT PORT button**  
Press this button to open the OUTPUT PORT window, in which you can make output port settings.
- ⑫ **MIDI/GPI button**  
Press this button to open the MIDI/GPI window, in which you can make MIDI and GPI-related settings.
- ⑬ **DANTE SETUP button**  
Press this button to open the DANTE SETUP window. This window enables you to make various audio network settings (console ID setting; SECONDARY PORT functionality setting; audio bit rate; latency setting; and selections for devices controlled via the I/O DEVICE screen).

## ■ BUS SETUP field

This field enables you to make bus-related settings.

### ⑭ BUS SETUP button

Press this button to open the BUS SETUP window, in which you can make MIX bus/MATRIX bus-related settings.

## ■ DATE/TIME button

Press this button to open the DATE/TIME window, in which you can set the date and time.

## ■ NETWORK button

Press this button to open the NETWORK window, in which you can set the network address.

## ■ Indicator field

This field displays various information about the console.

### ⑮ BATTERY indicator

Indicates the status of the internal battery.

#### NOTE

The LOW or NO indication will appear if the battery runs down. In this case, immediately contact your Yamaha dealer or a Yamaha service center listed at the end of the operating manual (separate document) to have the backup battery replaced.

### ⑯ POWER SUPPLY indicator

Indicates the currently-running power supply.

- INT .....Internal

### ⑰ Version indicator

Indicates the version number of the CPU and DANTE module.

## ■ CONSOLE LOCK button

This button executes the Console Lock function. If the console password has been set, pressing this button will open the AUTHORIZATION window. Enter the correct password to execute Console Lock.

If the console password has not been set, pressing this button will execute Console Lock immediately.

## ■ CONTRAST/BRIGHTNESS field

This field enables you to set the LCD brightness and contrast.

### ⑱ BANK A/BANK B buttons

Select a bank to which you want to save the brightness and contrast settings. You can save two different settings in bank A and B, and switch between them if desired.

### ⑲ CONTRAST NAME knob

Adjusts the contrast of the channel name display.

### ⑳ BRIGHTNESS NAME knob

Adjusts the brightness of the channel name display.

#### BRIGHTNESS CH COLOR knob

Adjusts the brightness balance of the channel color and the channel name display.

#### BRIGHTNESS SCREEN knob

Adjusts the brightness of the display.

#### BRIGHTNESS PANEL knob

Adjusts the brightness of the panel LEDs.

#### BRIGHTNESS LAMP knob

Adjusts the brightness of the lamp connected to the LAMP connector.

## User settings

User Level settings allow you to restrict the parameters that can be operated by each user, or to change the settings of USER DEFINED keys and preference settings for each user. Settings for each user can be stored as a “user authentication key” inside the console or together on a USB flash drive, allowing users to be switched easily. This can be convenient in the following situations.

- Unintended or mistaken operation can be prevented.
- The range of functionality operable by an outside engineer (guest engineer) can be limited.
- In situations in which multiple operators alternate with each other, output settings etc. can be locked to prevent unintended operations.
- Preferences of each operator can easily be switched.

## User types and user authentication keys

There are three types of user, as follows. To operate the QL series console, you must log-in as a user.

- **Administrator**..... The administrator of the QL console can use all of its functionality. Only one set of Administrator settings is internally maintained in the console. The Administrator can create user authentication keys for other users. Even if the console was locked by another user, the administrator can use the administrator password to unlock it.

- **Guest** .....A Guest can use only the range of functionality permitted by the Administrator. Only one set of Guest settings is maintained inside the console.
- **User** .....A User can use only the range of functionality permitted by the Administrator. User settings are saved internally or on a USB flash drive as user authentication keys. Multiple sets of user settings (up to ten in internal memory) can be saved, each with the desired user name. A User who has Power User privileges can create or edit user authentication keys with a specified user level.

When a user logs in, the user settings for that user are applied. User settings include the following information.

- Password (except for Guest)
- User Level settings (except for Administrator)
- Preferences
- USER DEFINED keys
- USER DEFINED knobs
- Custom fader bank
- MASTER fader

Privileges for each user are as follows.

Logged-in user	Editing user setup data, such as USER DEFINED keys and Preferences	Editing User Level settings	Password setting	Editing comments	User authentication key	
					Create new	Overwrite -save
Administrator	Available (Can edit the settings for Administrator and for Guest.)	Available (Cannot edit the user level, since the administrator can always perform all operations. Can edit the settings for Guest.)	Available	—	Available	—
User	Power user	Available	Available	Available	Available	Available
	Normal user (User without Power User privileges)	Available	N/A (Viewing only)	Available	Available	Available (Excluding User Level settings)
Guest	Available	N/A (Viewing only)	—	Available	—	—

## Setting the Administrator password

With the factory settings, the Administrator password is not set, meaning that anyone can log in with Administrator privileges and perform all operations. If you want to restrict the operations of other users, you must specify an Administrator password.

### STEP

1. In the Function Access Area, press the **SETUP** button.
2. In the **SETUP** screen, press the **PASSWORD CHANGE** button.
3. In the keyboard window, enter the password in the **NEW PASSWORD** field, then enter the same password in the **RE-ENTER PASSWORD** field for verification, and finally press the **OK** button.



SETUP screen



Keyboard window

### NOTE

- The password can be up to eight characters. If the two passwords that were entered match, the Administrator password will be set.
- For details on entering a password, refer to “Assigning a name” in the separate Owner’s Manual.

## Creating a user authentication key

You can create a user authentication key and save it on a USB flash drive or in the console’s internal memory. A user authentication key can be created only by an Administrator or Power User. The user level is specified when the authentication key is created, but USER SETUP settings other than the user level (such as preferences and the USER DEFINED keys) will be carried over from the user who is currently logged-in.

### NOTE

- You can store ten keys in the console’s internal memory.
- The file name of the user authentication key will be the current user name, and it will be created and saved in the root directory.

**STEP**

1. To create a user authentication key on a USB flash drive, connect a USB flash drive to the USB connector.
2. In the Function Access Area, press the SETUP button.
3. In the SETUP screen, press the CREATE USER KEY button.
4. In the CREATE USER KEY window, when you have specified the user name, comment, password, power user privileges on/off, and user rights, press the CREATE button.
5. If you want to create a user authentication key in the console's internal memory, press a button in the CREATE TO INTERNAL STORAGE field in the CREATE KEY window. If you want to create a user authentication key on your USB flash drive, press the button in the CREATE TO USB STORAGE field.
6. Press the CREATE TO button.
7. Press the OK button in the confirmation dialog box.



SETUP screen



CREATE USER KEY window

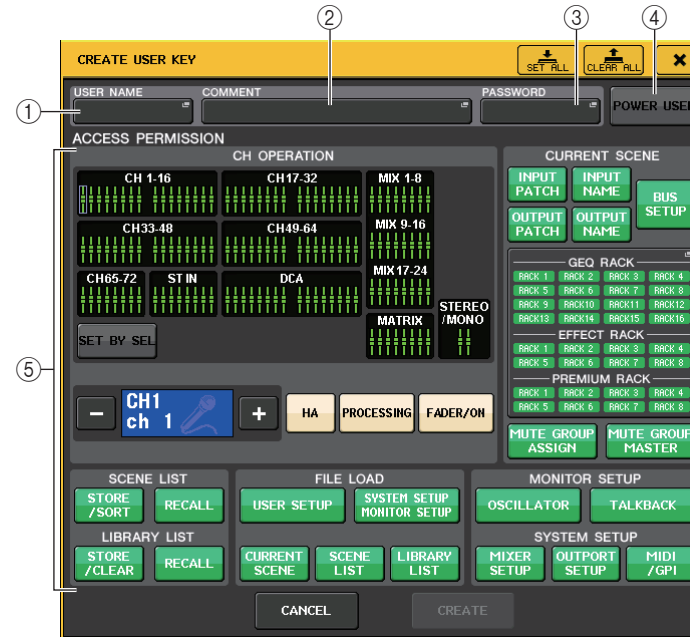

CREATE KEY window

**CREATE USER KEY window****① USER NAME**

Displays the user name. Press this area to access a keyboard window, in which you can enter a user name of up to eight characters.

**② COMMENT**

Displays a comment about the user. Press this area to access a keyboard window, in which you can enter a comment of up to 32 characters.

**③ PASSWORD**

Enables you to specify a password. Press this area to access a keyboard window, in which you can enter a password of up to eight characters.

**④ POWER USER**

Specifies whether Power User privileges will be granted to this user.

**⑤ ACCESS PERMISSION**

These settings specify the range of operations that the user can perform. For details on each item, refer to [page 165](#).

**NOTE**

In the case of the QL1, faders that do not exist on the model will not be shown.



## Logging-in

To operate the QL series console, you must log in as the Administrator, Guest, or a User. User settings for the Administrator and Guest are saved in the console itself. However, to log in as a User you must either select a key that is saved in the console itself, or connect the USB flash drive in which a user authentication key has been saved. If you use a user authentication key on a USB flash drive, you will continue as the logged-in user even if you remove the USB flash drive after logging-in.

### NOTE

If the power is turned off and then on again, the console will generally start up in the log-in state in which the power was turned off. If a user password has been assigned, you will need to enter the password. However if you cancel the input, you will be forcibly logged-in as Guest.

## Logging-in as Administrator

### STEP

1. In the Function Access Area, press the SETUP button.
2. In the SETUP screen, press the CURRENT USER button.
3. In the LOGIN window, press the ADMINISTRATOR button.
4. Enter the password and press the OK button.

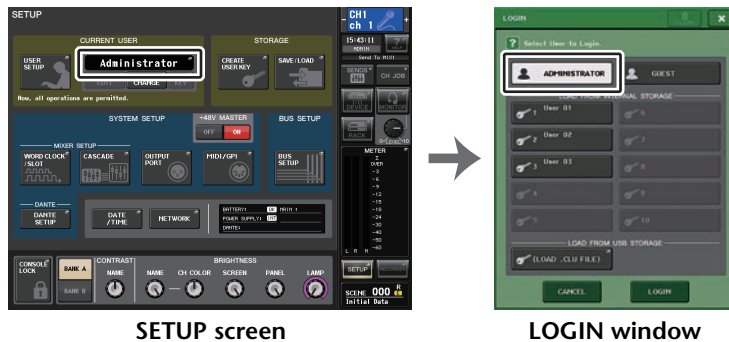

### NOTE

- If no Administrator password has been set, you will simply be logged-in in step 3 when you press the LOGIN button. If a password has been set, a keyboard window will appear, allowing you to enter the password.
- If the password was incorrect, a message of "Wrong Password!" will appear near the bottom of the screen.

## Logging-in as Guest

### STEP

1. In the Function Access Area, press the SETUP button.
2. In the SETUP screen, press the CURRENT USER button.
3. In the LOGIN window, press the GUEST button, and then press the LOGIN button.

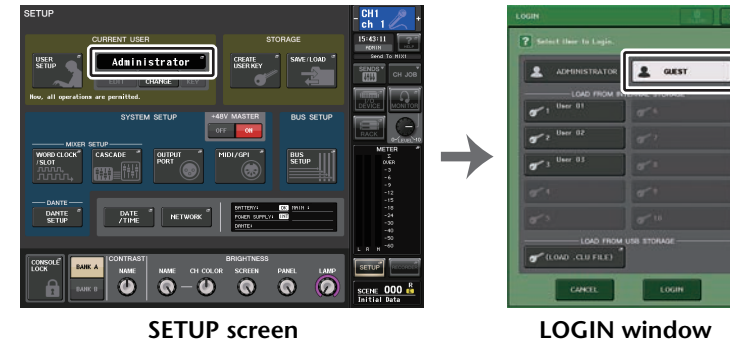

## Logging-in as a User

To log in as a User, you will use a user authentication key saved in the console or on a USB flash drive. If using a USB flash drive, you may also log-in using a user authentication key created on a different QL series console.

With a user authentication key stored in the console

### STEP

1. In the Function Access Area, press the SETUP button.
2. In the SETUP screen, press the CURRENT USER button.
3. In the LOAD FROM INTERNAL STORAGE field of the LOGIN window, choose the user authentication key with which you want to log in, and press the LOGIN button.
4. Enter the password and press the OK button.

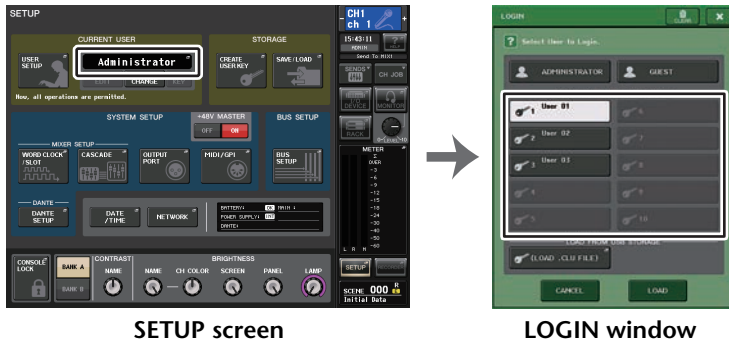

SETUP screen

LOGIN window

**NOTE**

- If no password has been set, you will simply be logged-in in step 3 when you press the LOGIN button.
- If the password was incorrect, a message of “Wrong Password!” will appear near the bottom of the screen.

**With a user authentication key stored in a USB flash drive****STEP**

1. Connect the USB flash drive to the USB connector.
2. In the Function Access Area, press the SETUP button.
3. In the SETUP screen, press the CURRENT USER button.
4. In the LOAD FROM USB STORAGE field of the LOGIN window, press the (LOAD .CLU FILE) button.
5. In the SAVE/LOAD window, choose the user authentication key with which you want to log in.
6. Press the LOAD button.
7. Enter the password and press the OK button.

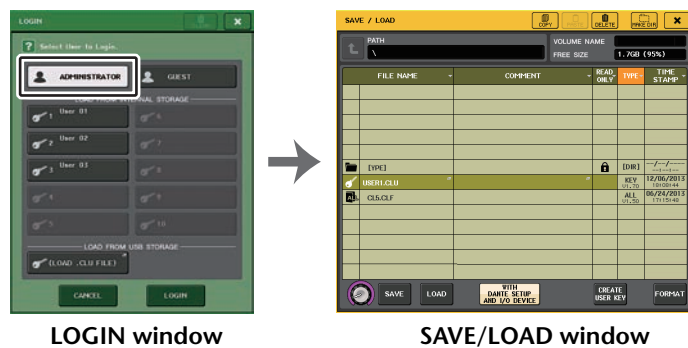

LOGIN window

SAVE/LOAD window

**NOTE**

- If no password has been set, you will simply be logged-in in step 6 when you press the LOAD button.
- If the password was incorrect, a message of “Wrong Password!” will appear near the bottom of the screen.
- If you have selected a user authentication key that was created on a different QL series console, a keyboard window will appear, allowing you to enter the Administrator password of the QL series console that you will be using. (If the Administrator passwords are identical, this window will not appear.) When you enter the correct Administrator password, another keyboard window will appear, allowing you to enter the password for the selected user. If you re-save the user authentication key, you will not be asked for the Administrator password the next time. Refer to “Editing a user authentication key” on page 165.
- For details about loading files from the USB flash drive, refer to “Loading a file from a USB flash drive” on page 180.

**Changing the password**

Follow the steps below to change the password of the logged-in user. The Guest account does not have a password.

**STEP**

1. In the Function Access Area, press the SETUP button.
2. In the SETUP screen, press the PASSWORD CHANGE button.
3. In the keyboard window, enter the current password and press the OK button.
4. Enter the new password in the NEW PASSWORD field, then enter the same password in the RE-ENTER PASSWORD field for verification, and finally press the OK button.
5. Refer to “Editing a user authentication key” on page 165 to overwrite the user authentication key.

**NOTE**

After you change the password, if you log out from the console without saving the user authentication key, the changed password will be discarded.

## Editing a user authentication key

If you are logged-in as a user, you can edit your preference settings, USER DEFINED keys, USER DEFINED knobs, assignable encoders, custom fader banks, master fader, comments, and password, and save (overwrite) them onto your user authentication key. If you are logged-in as a Power User, you can also change the user level.

### STEP

1. Log in as a user, and edit the Preference settings (page 167), USER DEFINED keys (page 169), USER DEFINED knobs (page 173), and custom fader bank (page 175) settings.
2. Close the USER SETUP window.
3. In the SETUP screen, press the SAVE KEY button.
4. In the SAVE KEY window, choose the save-destination button, and then press the SAVE TO button.
5. A dialog box will ask you to confirm that you want to overwrite that user authentication key; press the OK button.



SETUP screen

SAVE KEY window

### NOTE

If you are logged-in as a Power User, you can also change the user level.

## Changing the user level

You can view or change the user level.

- **Administrator**.....The Administrator does not have a user level setting, but can change the user level setting of the Guest account.
- **Guest**.....The Guest can view the user level setting of the Guest account, but cannot change it.
- **Normal user**.....A normal user can view the user level setting of his or her User account, but cannot change it.
- **Power User**.....A power user can view and change his or her User account.

### STEP

1. In the Function Access Area, press the SETUP button.
2. In the SETUP screen, press the USER SETUP button.
3. In the USER SETUP window, press the USER LEVEL tab. (If you are logged-in as the Administrator, press the FOR GUEST button to switch to the USER LEVEL for Guest page.)
4. Specify the user level by pressing the button for each item that will be permitted.
5. When you have finished making settings, close the window and press the SETUP button in the Function Access Area.

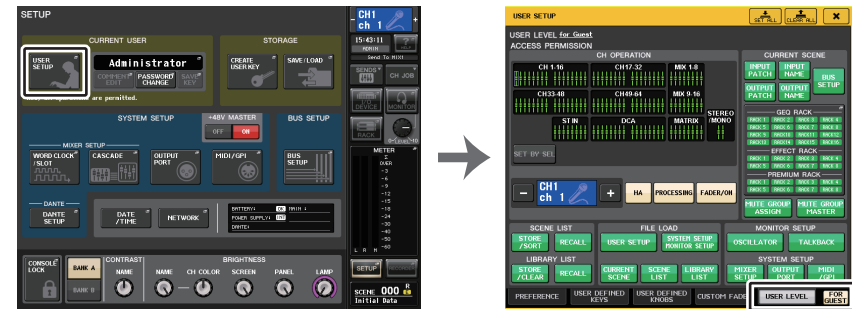

SETUP screen

USER SETUP window

## USER SETUP window

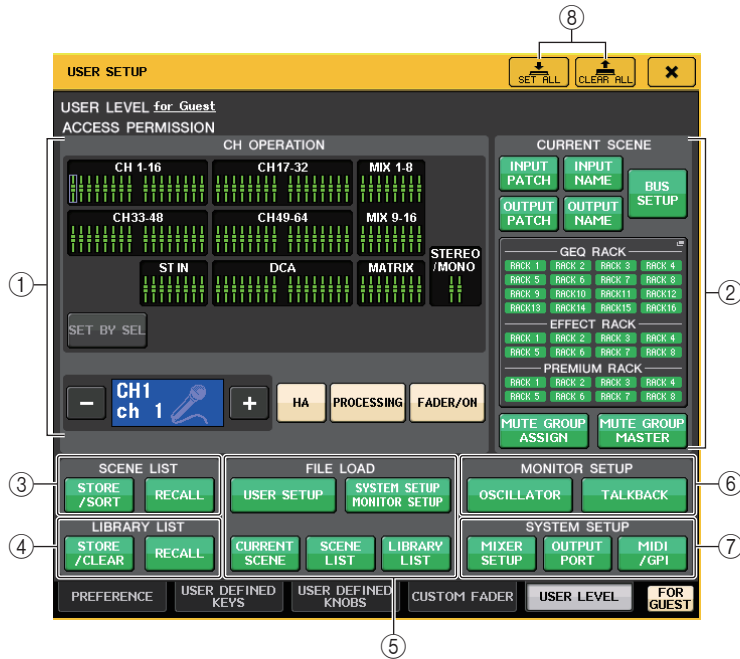

### ① CH OPERATION

Here you can specify (for each channel) the operations that will be permitted for input channels, output channels, and DCA groups. The settings will apply to the currently-selected channel.

Settings for currently-selected channels will be displayed below the CH OPERATION section. Use the panel [SEL] keys or the Selected Channel field in the Function Access Area to select the channel for which you want to make settings. The type of buttons shown will depend on the selected channel or group.

- **INPUT channel**..... [HA], [PROCESSING], [FADER/ON]
- **MIX/MATRIX channel**..... [WITH SEND], [PROCESSING], [FADER/ON]
- **STEREO/MONO channel**  
..... [PROCESSING], [FADER/ON]
- **DCA group** ..... [DCA MASTER], [DCA GROUP ASSIGN]
- **HA**..... Restricts operation of the HA (Head Amp) patched to that channel.
- **PROCESSING** ..... Restricts operation of all signal processing parameters for that channel (excluding the fader, channel on/off, and send level).
- **FADER/ON**..... Restricts operation of that channel's fader, channel on/off, and send level.

- **WITH SEND**..... Restricts operation of that channel's send parameters. (From MIX, From MATRIX)
- **DCA MASTER** ..... Restricts operation of that channel's DCA group fader, ON/OFF, and ICON/COLOR/NAME.
- **DCA GROUP ASSIGN**..... Restricts changes of assignment to that DCA group.
- **SET BY SEL** ..... If this button is on, you can press the panel [SEL] key of a channel to enable or disable the above-mentioned operating restrictions for that channel.

### ② CURRENT SCENE

Specifies the operations that can be performed on the current scene memory.

- **INPUT PATCH/INPUT NAME**  
..... Restricts operations for input channel patching and names.
- **OUTPUT PATCH/INPUT NAME**  
..... Restricts operations for output channel patching and names.
- **BUS SETUP** ..... Restricts operations for bus setup.
- **GEQ RACK/EFFECT RACK/PREMIUM RACK**  
..... Restricts operations for the racks. Press this area to open the RACK USER LEVEL window, in which you can set this restriction.  
However, there will be no restriction on operating the MIDI CLK button displayed for delay-type and modulation-type effects, or the PLAY/REC button displayed for the FREEZE effect.
- **MUTE GROUP ASSIGN/MUTE GROUP MASTER**  
..... Restricts operations for mute group assignment and mute group master.

### NOTE

In the case of the QL1, faders that do not exist on the model will not be shown.

### ③ SCENE LIST

Specifies the operations that can be performed on scene memories.

- **STORE/SORT operations**
- **RECALL operations**

### ④ LIBRARY LIST

Specifies the operations that can be performed on libraries.

- **STORE/CLEAR operations**
- **RECALL operations**

⑤ **FILE LOAD**

Specifies the settings that will be applied when a file is loaded from a USB flash drive. The user authentication key contains settings such as the user level, preferences, and the USER DEFINED key settings (USER SETUP settings). Other data is saved in an "ALL" file. The "ALL" file also includes the USER SETUP settings of the Administrator and the Guest.

- **USER SETUP (Preference and USER DEFINED keys settings)**
- **SYSTEM SETUP/MONITOR SETUP**
- **CURRENT SCENE**
- **SCENE LIST**
- **LIBRARY LIST**

⑥ **MONITOR SETUP**

Specifies the monitor setup operations that can be performed.

- **OSCILLATOR**
- **TALKBACK**

⑦ **SYSTEM SETUP**

Specifies the system setup operations that can be performed.

- **MIXER SETUP**
- **OUTPUT PORT**
- **MIDI/GPI**

⑧ **SET ALL/CLEAR ALL button**

Permits/clears all items.

## Preferences

Follow the steps below to make various settings for the QL console operating environment, such as how windows appear, and whether [SEL] key on/off operations will be linked. These settings are changed for the user who is logged-in, but if you are logged-in as the Administrator, you will also be able to change the Guest settings.

### STEP

1. In the Function Access Area, press the **SETUP** button.
2. In the **SETUP** screen, press the **USER SETUP** button.
3. In the **USER SETUP** window, press the **PREFERENCE** tab.
4. Use the buttons on screen to make Preference settings.
5. When you have finished making settings, close the window and press the **SETUP** button in the Function Access Area.

### NOTE

If you are logged-in as the Administrator, you can also turn on the **FOR GUEST** button to access the **PREFERENCE** for Guest page and make preference settings for the Guest account.

## USER SETUP window (PREFERENCE page)

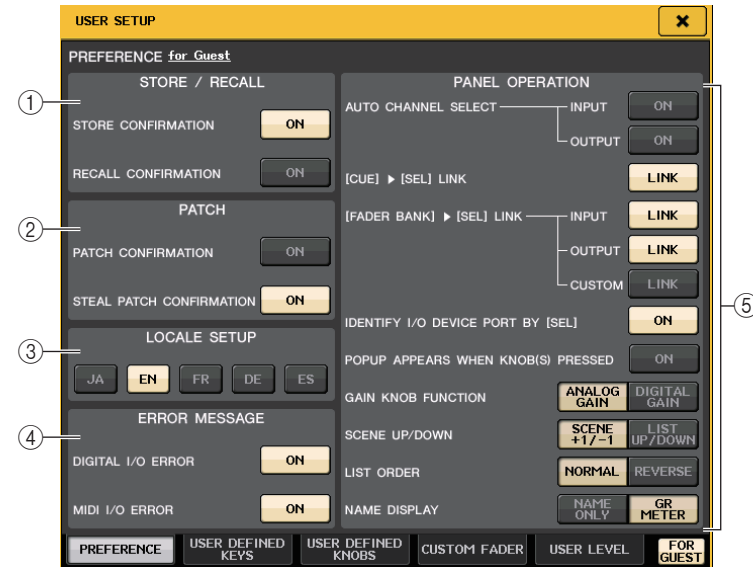
① **STORE/RECALL field**

Enables you to turn on or off options related to scene store/recall operations.

- **STORE CONFIRMATION**
- **RECALL CONFIRMATION**

If these ON buttons are lit, a confirmation message will appear when you perform a Store or Recall operation respectively.

② **PATCH field**

Enables you to turn on or off options related to patch operations.

- **PATCH CONFIRMATION**
- **STEAL PATCH CONFIRMATION**

If this ON button is lit, a confirmation message will appear when you edit an input patch or output patch.

③ **LOCALE SETUP field**

In the **SAVE/LOAD** screen or **RECORDER** screen, select **JA** if you want Japanese to be displayed.

(This does not select the Help language.)

④ **ERROR MESSAGE field**



Specifies whether error messages will be displayed.

- **DIGITAL I/O ERROR**  
If this is on, an error message will appear when a digital audio I/O error occurs.
  - **MIDI I/O ERROR**  
If this is on, an error message will appear when a MIDI transmit/receive error occurs.
- ⑤ **PANEL OPERATION field**  
Enables you to make settings for options related to panel operation.
- **AUTO CHANNEL SELECT**  
Specifies whether the corresponding channel will be selected when you operate the [ON] key or fader for the channel. You can set this parameter separately for INPUT (input channels) and OUTPUT (output channels).
  - **[CUE] ► [SEL] LINK**  
Specifies whether channel selection will be linked with cue operations. If the LINK button is on, channels for which cue operations were performed will be selected.
  - **[FADER BANK] ► [SEL] LINK**  
Specifies whether channel selection will be linked with fader bank selection. You can set this parameter separately for INPUT (input channels), OUTPUT (output channels), and CUSTOM (Custom fader bank).  
If the LINK button is on, and you select the corresponding fader bank, the channel in that bank that was selected most recently will be selected, and its [SEL] key will light.
  - **IDENTIFY I/O DEVICE PORT BY [SEL]**  
Specifies whether to enable a function that allows you to identify the I/O device port connected to a channel by pressing the [SEL] key for that channel.  
If this ON button is lit, pressing a [SEL] key on the panel will cause the signal indicator to flash for the port of the I/O device that is assigned to the corresponding channel by the INPUT PATCH/OUTPUT PATCH settings.
  - **POPUP APPEARS WHEN KNOB(S) PRESSED**  
Specifies whether pressing a knob in the SELECTED CHANNEL section of the panel while the SELECTED CHANNEL VIEW screen is displayed will cause a window (1ch) to appear. If the ON button is lit, a window (1ch) will open (or close) whenever you press a knob.
- NOTE**  
If you press the SEND or PAN knob, a window (8ch) will open.
- **GAIN KNOB FUNCTION**  
Specifies what will happen when you operate the [TOUCH AND TURN] knob. When ANALOG GAIN button is lit, you can adjust analog gain on the head amp. When DIGITAL GAIN button is lit, you can adjust digital gain on the console.
  - **SCENE UP/DOWN**  
Specifies what the USER DEFINED key assigned to INC RECALL or DEC RECALL will do when pressed in the SCENE windows.  
When the SCENE +1/-1 button is lit, pressing the USER DEFINED key assigned to INC RECALL or DEC RECALL will increment or decrement the scene number.  
When the LIST UP/DOWN button is lit, pressing the USER DEFINED key assigned to INC RECALL or DEC RECALL will scroll the list upward or downward.

- **LIST ORDER**  
Specifies the order in which scene memories and library items will appear on the list. When the NORMAL button is lit, the list appears in ascending numerical order. When the REVERSE button is lit, the list appears in descending numerical order.
- **NAME DISPLAY**  
Specifies the content of the name display in the Channel Strip section. When the NAME ONLY button is lit, the channel name and the channel number appear. When the GR METER button is lit, GR METER information and fader level are also displayed.

**NOTE**

The GR METER simply lets you confirm the changes in gain reduction.

	
GR METER display	Highlighted display (The channel is off in SENDS ON FADER mode.)



## USER DEFINED keys

This section explains how to assign the desired functions to the USER DEFINED keys in the USER DEFINED KEYS section on the top panel, and to press these keys to execute the defined function.

If you are logged-in as a user, you can make USER DEFINED key settings for the user. If you are logged-in as the Administrator, you can also make the USER DEFINED key settings for the Guest account.

### NOTE

For details on the assignable functions and their parameters, refer to “[Functions that can be assigned to USER DEFINED keys](#)” on [page 170](#).

### STEP

1. In the Function Access Area, press the **SETUP** button.
2. In the **SETUP** screen, press the **USER SETUP** button.
3. In the **USER SETUP** window, press the **USER DEFINED KEYS** tab.
4. Press the button corresponding to the USER DEFINED key to which you want to assign a function.
5. In the **FUNCTION** field of the USER DEFINED KEY SETUP window, select the function you want to assign.
6. If the selected function has parameters, press the **PARAMETER 1** or **2** field to move the frame, then select parameters **1** and **2** in the same way.
7. Press the **OK** button to close the USER DEFINED KEY SETUP window.
8. To execute an assigned function, press the corresponding USER DEFINED [1]–[12] key on the panel.

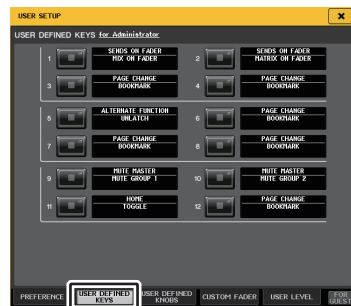

USER SETUP window  
(USER DEFINED KEYS page)

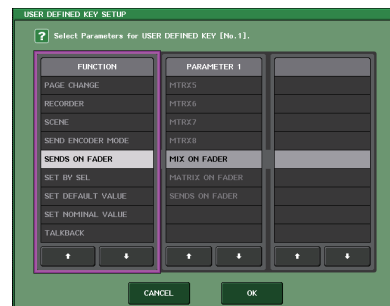

USER DEFINED KEY SETUP window

### NOTE

- If you are logged-in as the Administrator, you can also turn on the FOR GUEST button to access the USER DEFINED KEYS for Guest page and make USER DEFINED key settings for the Guest account.

- The twelve buttons in the USER DEFINED KEYS page correspond to USER DEFINED keys [1]–[12] on the top panel. The name of the function or parameter assigned to each key appears to the right of the corresponding button. If nothing is assigned to the key, an indication of “---” will appear next to the button.
- The list shown in the USER DEFINED KEY SETUP window is the same for all models of the QL series.  
For the QL1, the display will indicate “Cannot Assign!” if you specify a parameter that does not exist on that model.

## Using the Alternate function

If you assign the Alternate function (ALTERNATE FUNCTION) to a USER DEFINED key, you will be able to switch parameters on or off by operating the knobs in the SELECTED CHANNEL section while pressing and holding down the USER DEFINED key.

The console enters Alternate mode when you press and hold down the USER DEFINED key to which the Alternate function has been assigned (the key will light).

The Alternate function features two options: LATCH and UNLATCH.

- **UNLATCH** ..... Alternate mode is turned on only while you are pressing and holding down the USER DEFINED key.
- **LATCH** ..... Each press of the USER DEFINED key will turn Alternate mode on or off. You do not need to hold down the key.

### NOTE

- If you select LATCH for the Alternate function, the console disables the Alternate function when you switch the display between the OVERVIEW screen and the SELECTED CHANNEL VIEW screen, or when you open a window.
- In Alternate mode, “ALT” will be displayed in the user name field of the Function Access Area.

In Alternate mode, the following knobs change their behavior.

- **[GAIN] knob**  
Rotate the knob to adjust the digital gain value. If DIGITAL GAIN has been selected for HA KNOB FUNCTION on the PREFERENCE page in the USER SETUP window, rotate this knob to adjust the analog gain value of the head amp.
- **[HPF] knob**  
Press this knob to switch the high-pass filter on or off.
- **[DYNAMICS 1] knob**  
Press this knob to switch DYNAMICS 1 on or off.
- **[DYNAMICS 2] knob**  
Press this knob to switch DYNAMICS 2 on or off.

### NOTE

In Alternate mode, all knobs in the SELECTED CHANNEL section other than those knobs mentioned above will be disabled.



## Functions that can be assigned to USER DEFINED keys

FUNCTION	PARAMETER 1	PARAMETER 2	Explanation	
NO ASSIGN	—	—	No assignment.	
ALTERNATE FUNCTION	LATCH	—	Toggle ALTERNATE FUNCTION each time it is pressed.	
	UNLATCH	—	Switch to ALTERNATE FUNCTION only while pressed.	
AUTOMIXER	group a OVERRIDE ON	—	Apply a fade-in to the channels in group a where the override button is on, until the level drops to 0 dB (the unity gain). Mute all channels with the button turned off.	
	group a PRESET ON	—	Switch the channels in group a to the mode indicated by the mode button (man/auto/mute) next to the lit preset indicator.	
	group b OVERRIDE ON	—	Apply a fade-in to the channels in group b where the override button is on, until the level drops to 0 dB (the unity gain). Mute all channels with the button turned off.	
	group b PRESET ON	—	Switch the channels in group b to the mode indicated by the mode button (man/auto/mute) next to the lit preset indicator.	
	group c OVERRIDE ON	—	Apply a fade-in to the channels in group c where the override button is on, until the level drops to 0 dB (the unity gain). Mute all channels with the button turned off.	
	group c PRESET ON	—	Switch the channels in group c to the mode indicated by the mode button (man/auto/mute) next to the lit preset indicator.	
BRIGHTNESS	BANK CHANGE	—	Toggle between the brightness settings stored in A and B.	
CH ON	SPECIFIC CH	*4)	Switch the CH ON/OFF.	
CH SELECT	INC	—	Increment or decrement the selected channel number.	
	DEC	—		
	SPECIFIC CH	*1)	Select a channel from list 1).	
QL EDITOR CONTROL	MASTER	—	Access the corresponding screen of QL Editor.	
	SENDS ON FADER	—		
	OVERVIEW	CH 1-16 {QL5/QL1}		
		CH17-32 {QL5/QL1}		
		CH33-48 {QL5/QL1}		
		CH49-64 {QL5}		
		ST IN		
		MIX1-16		
		MATRIX		
		STEREO/MONO		
DCA				

FUNCTION	PARAMETER 1	PARAMETER 2	Explanation	
QL EDITOR CONTROL	Custom fader bank	B1	Access the corresponding screen of QL Editor.	
		B2		
		B3		
		B4		
	SELECTED CHANNEL	—		
	LIBRARY			DYNAMICS LIBRARY
				INPUT EQ LIBRARY
				OUTPUT EQ LIBRARY
				EFFECT LIBRARY
				GEQ LIBRARY
				INPUT CH LIBRARY
	PREMIUM RACK LIBRARY			OUTPUT EQ LIBRARY
				Portico5033 LIBRARY
				Portico5043 LIBRARY
				U76 LIBRARY
				Opt-2A LIBRARY
				EQ-1A LIBRARY
	PATCH EDITOR			DynamicEQ LIBRARY
				INPUT PATCH
				OUTPUT PATCH
				INPUT INSERT PATCH
				OUTPUT INSERT PATCH
				DIRECT OUT PATCH
	RACK EDITOR			PATCH LIST
				RACK
				GEQ 1-8
				EFFECT 1-8
		PREMIUM 1A		
		PREMIUM 1B		
		:		
		PREMIUM 8A		
		PREMIUM 8B		
METER			INPUT METER	
		OUTPUT METER		
GROUP/LINK		DCA GROUP		
		MUTE GROUP		
		CHANNEL LINK		
SCENE		SCENE MEMORY		
		RECALL SAFE		
		Fade time		
		FOCUS RECALL		

FUNCTION	PARAMETER 1	PARAMETER 2	Explanation
CUE	OUTPUT		Switch CUE on/off.
	CLEAR CUE		
	SPECIFIC CH	*2)	CUE the channel selected from list 2).
	CUE MODE		Select the CUE MODE.
EFFECT BYPASS	EFFECT RACK1-8		
	PREMIUM RACK1A		
	PREMIUM RACK1B		
	:		
	PREMIUM RACK8A		
GAIN KNOB FUNCTION	LATCH	—	Toggle the function of the GAIN knob (ANALOG GAIN/DIGITAL GAIN). Lit when DIGITAL GAIN is selected.
	UNLATCH	—	Assign the function of the GAIN knob (ANALOG GAIN/DIGITAL) to DIGITAL GAIN only while held down. * However if the GAIN KNOB FUNCTION is switched to DIGITAL GAIN in the PREFERENCE screen etc., this will remain lit until the next time it is pressed.
GEQ FREQ BANK	INC DEC	—	Adds or removes a frequency bank in the GEQ EDIT screen.
GPI OUT	LATCH	PORT1-PORT5	Toggle the GPI OUT function. Lit when active.
	UNLATCH		Make GPI OUT active only while pressed.
HELP	—	—	Opens and closes the HELP window. Operating the controllers on the panel (excluding faders), or controllers on the screen, while holding down this key will display the related information.
HOME	SELECTED CH VIEW	—	Displays the SELECTED CHANNEL VIEW screen.
	OVERVIEW	—	Displays the OVERVIEW screen.
	TOGGLE	—	Each press of the key will alternately display the SELECTED CHANNEL VIEW screen and the OVERVIEW screen.
METER	PEAK HOLD ON	—	Turns the meter's peak hold function on/off. Lit when on.
MIDI	PROGRAM CHANGE	PGM 1-128	Transmit the corresponding MIDI message.
	CONTROL CHANGE	CC 1-31, 33-95, 102-119	
	NOTE ON	NOTE ON C-2 (0)	
		:	
	NOTE ON G 8 (127)		

FUNCTION	PARAMETER 1	PARAMETER 2	Explanation	
MONITOR	MONITOR ON	—	Switch MONITOR on/off.	
	OUTPUT		Switch the monitor output on/off.	
	SELECTED CH ASSIGN	—	While holding down this key, press the SEL key of a MIX or MATRIX channel to switch the assignment on/off. During this time, the [SEL] LED will be lit if assign is ON, or dark if OFF. The assignment setting made while holding down this key will be stored. Pressing the key again will recall the stored setting. Settings can be stored in multiple keys to facilitate rapid assignment switching.	
	DIMMER ON		Enable the dimmer and attenuate the monitor signal.	
	SOURCE SELECT	STEREO L/R	—	Recall the selected signal to the monitor.
		MONO (C)		
		LCR		
PB OUT				
*5)				
DEFINE				
MUTE MASTER	MUTE GROUP 1	—	Switch MUTE GROUP MASTER on/off.	
	:			
	MUTE GROUP 8			
	ALL MUTE	—	Turns all MUTE GROUP MASTER settings on/off together.	
NUENDO LIVE	TRANSPORT	GO TO PROJECT START	Operate the transport functions of Nuendo Live.	
		GO TO PREV MARKER		
		REWIND		
		FAST FORWARD		
		GO TO NEXT MARKER		
		GO TO PROJECT END		
		CYCLE		
		STOP		
		START		
		REC		
	EASY RECORDING			
	PEAK CLEAR	—	Clear the peak indicators of the Nuendo Live screen.	
OSCILLATOR	OSCILLATOR ON	—	Switch the OSC on/off.	
	SELECTED CH ASSIGN	—	While holding down this key, press a SEL key of a channel to switch the assignment on/off. During this time, the [SEL] LED will be lit if assign is ON, or dark if OFF.	
	DIRECT ASSIGN	*1)	Assign the oscillator to the channel selected from list 1).	

FUNCTION	PARAMETER 1	PARAMETER 2	Explanation
PAGE CHANGE	BOOKMARK		Memorize the currently-selected screen (hold down the key for two seconds or longer), or display the last-memorized screen (press and release the key within two seconds). Screens can also be memorized. In the case of a rack, the number of that rack is also memorized.
	BOOKMARK with "SEL"	—	Memorize the above BOOKMARK with the addition of the SEL status.
	PREVIOUS PAGE	—	Display the previous/next page.
	NEXT PAGE	—	
	CLOSE POPUP	—	Close the displayed window.
RECORDER	TRANSPORT	PLAY/PAUSE, STOP, FF/NEXT, REW/PREVIOUS, REC	Recorder transport functions.
		AUTO REC	Shortcut function for STOP → REC → PLAY. Recording will be initiated in a single action. If this is executed during recording, the file being recorded will first be closed, and then recording will continue with a new file.
		REC & START	Start recording immediately without entering record-ready mode.
	DIRECT PLAY	NO ASSIGN (TITLE 1)	The specified audio file will be played once from the beginning.
		:	Audio files to be played should be saved in the SONGS folder inside the YPE folder. Please note that a file cannot be specified if it is saved in the root directory or in any other folder. When you execute playback, the path in the TITLE LIST screen will move to \YPE\SONGS\.
SCENE	INC RECALL	—	Recall the scene of the next existing number.
	DEC RECALL	—	Recall the scene of the previous existing number.
	DIRECT RECALL	SCENE #000–#300	Directly recall the scene of the specified number.
	RECALL UNDO	—	Execute RECALL UNDO.
	STORE UNDO	—	Execute STORE UNDO.
	INC	—	Select the scene of the next existing number.
	DEC	—	Select the scene of the previous existing number.
	RECALL	—	Recall the currently-selected scene.
	STORE	—	Store the current settings.
SEND MODE	MIX/MATRIX	—	If INPUT or ST IN is selected, switch output bus channels (MIX, MATRIX) to be displayed in the SEND field of the SELECTED CHANNEL VIEW screen.
SENDS ON FADER	MIX1–MIX16	—	Switches the MIX ON FADER function for the selected MIX on and off.
	MTRX1–MTRX8		Switches the MATRIX ON FADER function for the selected MATRIX on and off.
	MIX ON FADER		Switches the MIX ON FADER function on and off.
	MATRIX ON FADER		Switches the MATRIX ON FADER function on and off.
	SENDS ON FADER		Switches the SENDS ON FADER function on and off.

FUNCTION	PARAMETER 1	PARAMETER 2	Explanation
SET BY SEL	SET [+48V]	—	Hold down this key and press SEL to switch it on/off. During this time, the [SEL] LED will be lit if on or dark if off. If SET [PRE SEND] is selected, "SEND ON FADER" mode is engaged while you are holding down the [SEL] key.
	SET [Ø]		
	SET [INSERT ON]		
	SET [DIRECT OUT ON]		
	SET [PRE SEND]		
	SET [TO STEREO]		
	SET [TO MONO]		
	SET [TO LCR]		
	SET [GAIN COMPENSATION]		
	SET[AUTOMIXER AUTO/MAN]		
SET DEFAULT VALUE	—	—	While holding down this key, press SELECTED CH or the [TOUCH AND TURN] knob to reset it to the default value.
SET NOMINAL VALUE	—	—	While holding down this key, press a [SEL] key to set the fader of that channel to nominal level. You can also push a knob in the SEND field of the SELECTED CHANNEL VIEW screen to set the send level to nominal level.
TALKBACK	TALKBACK ON	LATCH	Switch TALKBACK on/off.
		UNLATCH	Turn TALKBACK on while pressed.
	SELECTED CH ASSIGN	—	While holding down this key, press a SEL key of an OUTPUT channel to switch the assignment on/off. During this time, the [SEL] LED will be lit if assign is ON, or dark if OFF. The assignment setting made while holding down this key will be stored. Pressing the key again will recall the stored setting. Settings can be stored in multiple keys to facilitate rapid assignment switching.
		DIRECT ASSIGN	*3)
TAP TEMPO	CURRENT PAGE	—	Use the tap tempo function in the displayed screen.
	EFFECT RACK1–8	—	Use the tap tempo function for the specified effect.

\*1) QL5: CH1-CH64, QL1: CH1-CH32, ST IN 1L-ST IN 8R, MIX1-MIX16, MTRX1-MTRX8, ST L, ST R, MONO(C)

\*2) QL5: CH1-CH64, QL1: CH1-CH32, ST IN 1-ST IN 8, MIX1-MIX16, MTRX1-MTRX8, STEREO, MONO(C)

\*3) MIX1-MIX16, MTRX1-MTRX8, ST L, ST R, MONO(C)

\*4) QL5: CH1-CH64, QL1: CH1-CH32, ST IN 1-ST IN 8, MIX1-MIX16, MTRX1-MTRX8, STEREO, MONO(C), DCA1-DCA16

\*5) QL5: INPUT25/26-31/32, QL1: INPUT9/10-15/16

## USER DEFINED knobs

This section explains how to assign the desired functions to the USER DEFINED knobs in the lower part of the touch screen, and to press these knobs to execute the defined function.

If you are logged-in as a user, you can make USER DEFINED knob settings for the user. If you are logged-in as the Administrator, you can also make the USER DEFINED knob settings for the Guest account.

### NOTE

For details on the assignable functions and their parameters, refer to “Functions that can be assigned to USER DEFINED knobs” on page 174.

### STEP

1. In the Function Access Area, press the SETUP button.
2. In the SETUP screen, press the USER SETUP button.
3. In the USER SETUP window, press the USER DEFINED KNOBS tab.
4. Press the button corresponding to the USER DEFINED knob to which you want to assign a function.
5. In the USER DEFINED KNOB SETUP window, make sure that the FUNCTION field is enclosed by a frame, then select the function that you want to assign.
6. If the selected function has parameters, press the PARAMETER 1 or 2 field to move the frame, then select parameters 1 and 2 in the same way.
7. Press the OK button to close the USER DEFINED KNOB SETUP window.
8. To execute an assigned function, press the corresponding USER DEFINED [1]-[4] knob in the lower part of the touch screen, then operate the [TOUCH AND TURN] knob.

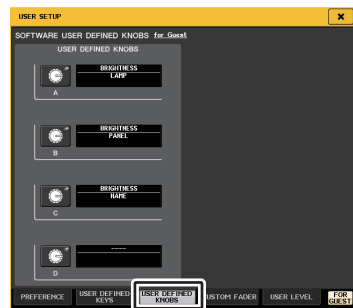

USER SETUP window  
(USER DEFINED KNOBS page)

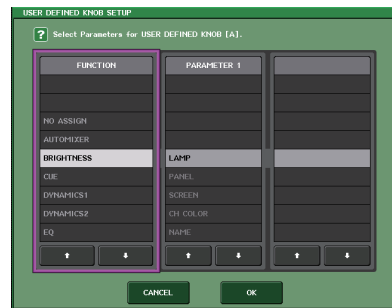

USER DEFINED KNOB SETUP window

### NOTE

- If you are logged-in as the Administrator, you can also turn on the FOR GUEST button to access the SOFTWARE USER DEFINED KNOBS for Guest page and make USER DEFINED knob settings for the Guest account.

- The four buttons in the SOFTWARE USER DEFINED KNOBS page correspond to USER DEFINED knobs [1]–[4] in the lower part of the touch screen. The name of the function or parameter assigned to each knob appears to the right of the corresponding button. If nothing is assigned to the knob, an indication of “---” will appear next to the button.
- The list shown in the USER DEFINED KNOB SETUP window is the same for all models of the QL series.

For the QL1, the display will indicate “Cannot Assign!” if you specify a parameter that does not exist on that model.

## About TOUCH AND TURN

You can press a desired knob in the touch screen and then use the [TOUCH AND TURN] knob to immediately operate that on-screen knob.

At this time, a pink frame is shown around the knob in the touch screen, indicating that you can operate that knob.



## Functions that can be assigned to USER DEFINED knobs

Function	PARAMETER 1	PARAMETER 2
NO ASSIGN		
AUTOMIXER	WEIGHT	*1)
BRIGHTNESS	LAMP	
	PANEL	
	SCREEN	
	CH COLOR	
	NAME	
CUE	INPUT PFL TRIM	
	DCA TRIM	
	OUTPUT PFL TRIM	
	CUE LEVEL	
DYNAMICS1	THRESHOLD	*2)
	RANGE	
	RATIO	
	ATTACK	
	HOLD	
	DECAY	
	RELEASE	
	OUTGAIN	
	KNEE	
	WIDTH	*13)
DYNAMICS2	THRESHOLD	*4)
	RATIO	
	FREQUENCY	
	ATTACK	
	RELEASE	
	OUTGAIN	
	KNEE	
	WIDTH	
EQ	ATT	*2)
	LOW Q	
	LOW FREQUENCY	
	LOW GAIN	
	LOW MID Q	
	LOW MID FREQUENCY	
	LOW MID GAIN	
	HIGH MID Q	
	HIGH MID FREQUENCY	
	HIGH MID GAIN	
	HIGH Q	

Function	PARAMETER 1	PARAMETER 2
EQ	HIGH FREQUENCY	*2)
	HIGH GAIN	
EXTERNAL HA	GAIN1–GAIN8	*10)
HPF	FREQUENCY	*4)
I/O DEVICE	GAIN1–GAIN32	*11)
INPUT DELAY	DELAY TIME	*3)
INPUT GAIN	ANALOG GAIN	*4)
	DIGITAL GAIN	
MIDI CONTROL CHANGE	CTRL 1–CTRL 31	
	CTRL 33–CTRL 95	
	CTRL 102–CTRL 119	
MONITOR	DIMMER LEVEL	
	TALKBACK DIMMER LEVEL	
	MONITOR DELAY	
	MONITOR FADER	
OSCILLATOR	LEVEL	
	SINE WAVE FREQUENCY	
	HPF	
	LPF	
	WIDTH	
	INTERVAL	
OUTPUT LEVEL	LEVEL	*6)
OUTPUT PORT	DELAY TIME	*12)
	GAIN	
SCENE	SELECT	
TO MIX LEVEL	MIX1–MIX16	*3)
TO MATRIX LEVEL	MATRIX1–MATRIX8	*7)
TO MIX PAN	MIX1/2–MIX15/16	*3)
TO MATRIX PAN	MATRIX1/2–MATRIX7/8	*7)
TO ST/MONO	PAN/BAL	*5)
	CSR	
TOUCH AND TURN		

\*1) SELECTED CH, Automixer ch1-6

\*2) SELECTED CH, QL5: CH1-CH64, QL1: CH1-CH32, ST IN 1-ST IN 8, MIX1-MIX16, MTRX1-MTRX8, STEREO, MONO (C)

\*3) SELECTED CH, QL5: CH1-CH64, QL1: CH1-CH32, ST IN 1L-ST IN 8R

\*4) SELECTED CH, QL5: CH1-CH64, QL1: CH1-CH32, ST IN 1-ST IN 8

\*5) SELECTED CH, QL5: CH1-CH64, QL1: CH1-CH32, ST IN 1L-ST IN 8R, MIX1-SIX16

\*6) MIX1-MIX16, MTRX1-MTRX8, STEREO, MONO (C)

\*7) SELECTED CH, QL5: CH1-CH64, QL1: CH1-CH32, ST IN 1L-ST IN 8R, MIX1-MIX16, ST L, ST R, MONO (C)

\*10) #1-#4

\*11) REMOTE HA #1-#8

\*12) QL5: DANTE1-64, QL1: DANTE1-32, QL5: OMNI 1-OMNI 16, QL1: OMNI 1-OMNI 8, SLOT1 1-SLOT1 16, SLOT2 1-SLOT2 16, DIGITAL OUT L, DIGITAL OUT R

\*13) SELECTED CH, MIX1-MIX16, MTRX1-MTRX8, STEREO, MONO (C)

## Custom fader bank

Groups that organize channels routed to the top-panel faders are called “fader banks.” There are input and output channel banks, as well as custom fader banks. Custom fader banks enable you to select various combinations of channels, regardless of channel types. This section explains how to set up a custom fader bank.

### STEP

1. In the Function Access Area, press the SETUP button.
2. In the SETUP screen, press the USER SETUP button.
3. In the USER SETUP window, press the CUSTOM FADER tab.
4. Use the Bank Select keys to recall the fader settings to the top panel for the channels you want to add to the custom fader bank.
5. In the CUSTOM FADER BANK/MASTER FADER page, press the bank select button for the custom fader bank you want to set up.
6. In the CHANNEL ASSIGN field, press the select button for the fader you want to set up.
7. Press a [SEL] key on the top panel to assign a channel to the fader number selected in step 6.
8. To assign channels to other faders, repeat steps 5 through 7.



USER SETUP window (CUSTOM FADER BANK/MASTER FADER page)

### NOTE

- If you are logged-in as the Administrator, you can also turn on the FOR GUEST button to access the CUSTOM FADER BANK/MASTER FADER for Guest page, and make custom fader bank settings for the Guest account.
- You can also press the channel select buttons to assign channels to faders.

## USER SETUP window (CUSTOM FADER BANK/MASTER FADER page)



### ① CUSTOM FADER BANK field

#### • Bank select buttons

Enable you to select a custom fader bank to which you want to assign a group of channels.

### ② Block indicators

Display the graphics of the top panel block and faders that are the current target for editing.

The graphics vary depending on the console model.

QL5: B (16 faders), MASTER

QL1: B (8 faders), MASTER

### ③ Fader select button

Selects the target fader. Press this button to select it, then press [SEL] keys on the top panel to add the corresponding channels to the selected fader bank.

### ④ Channel select button

Opens the channel select window, in which you can change the channel specified for CHANNEL ASSIGN.

### ⑤ CLEAR ALL button

Clears all the current fader bank assignment. Pressing this button will open a confirmation dialog box. Press OK to clear the assignment. Otherwise, press CANCEL to return to the previous screen without changing the setting.

## Custom fader bank settings for individual scenes

Custom fader bank settings can be stored/recalled for individual scenes. For details, refer to “Using the Focus Recall function” on page 80.

Custom fader bank settings

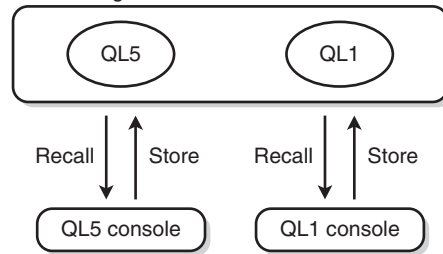

### NOTE

- Custom fader bank settings differ between models, and are not compatible. For example, scenes stored by the QL5 cannot be recalled on the QL1.
- In addition, the user level affects storing/recalling of custom settings. For example, if you are logged-in as a user or Guest, you cannot recall settings stored by the Administrator.

## Console Lock

You can temporarily prohibit console operations in order to prevent unwanted operation. This setting disables operations of the panel, so that controllers cannot be operated by an accidental touch or by an unauthorized third party while the operator is taking a break.

If a password is set for the currently logged-in user, that password will be used for the Console Lock function. When the Console Lock function is enabled, the CONSOLE LOCK screen will appear and all controllers will become inoperable.



### NOTE

- If you have forgotten the password, refer to “Initializing the unit to factory default settings” on page 210.
- The Guest cannot set a password.
- Even while the console is locked, you can operate the console from an external device via MIDI or QL Editor as usual.

## Locking the console

### STEP

1. In the Function Access Area, press the SETUP button.
2. In the SETUP screen, press the CONSOLE LOCK button.
3. If you are logged-in as a user for whom a password is set, enter the password for the user.
4. Press the OK button to enable Console Lock function.





SETUP screen

## Unlocking the console

### STEP

1. Press the CONSOLE LOCK screen.
2. If you are logged-in as a user for whom a password is set, enter the password for the user or for the Administrator, then press the OK button.

### NOTE

If you are logged-in as a user for whom no password is set, the console will be unlocked when you touch the CONSOLE LOCK screen.

## Specifying the CONSOLE LOCK screen image

If an image file has been saved on the USB flash drive, you can view that image on the CONSOLE LOCK screen.

In the SAVE/LOAD window, specify the image file that you want to display, and then load it from the USB flash drive. For details about loading files from the USB flash drive, refer to “Loading a file from a USB flash drive” on page 180.

### NOTE

Supported image file format is BMP in 800 x 600 pixels and 16/24/32-bit, but they will be converted into 16-bit for display.

## Saving and loading setup data to and from a USB flash drive

You can connect a commercially-available USB flash drive to the USB connector located to the right of the display, and save the internal settings and user authentication keys of the QL series console to the USB flash drive or load them from the USB flash drive.

### NOTICE

An ACCESS indicator is shown in the Function Access Area while data is being accessed (saved, loaded, or deleted). During this time, do not disconnect the USB port or power-off the QL unit. Doing so may damage the data in the flash drive.

### NOTE

- Operation is guaranteed only for USB flash drives.
- The operation of USB flash drives with capacities of up to 32GB has been verified. (However, this does not necessarily guarantee the operation of all USB flash drives.) The FAT16 and FAT32 formats are supported. A USB flash drive with a capacity of 4GB or larger will be formatted in FAT32, and a USB flash drive with a capacity of 2GB or smaller will be formatted in FAT16.

## Basic operation

### STEP

1. In the Function Access Area, press the SETUP button.
2. In the SETUP screen, press the SAVE/LOAD button.
3. Save/load/edit the data.



SETUP screen

## SAVE/LOAD window

The list will show the files and sub-directories that have been saved.

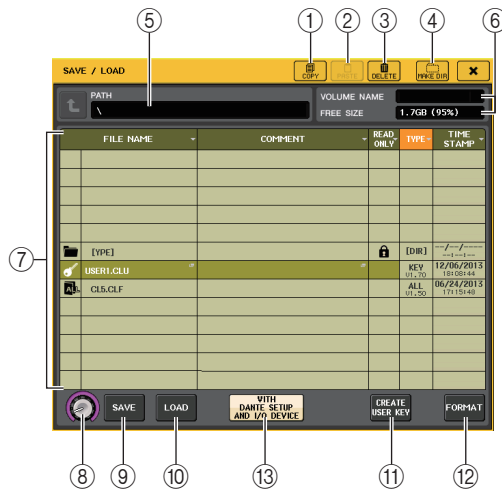

### ① COPY button

Copies a file into a memory buffer (a temporary holding area).

### ② PASTE button

Pastes the file that has been copied into a buffer memory.

### ③ DELETE button

Deletes the selected file or directory.

### NOTE

A directory cannot be deleted unless it is empty. The message "Directory Not Empty!" will appear.

### ④ MAKE DIR button

Creates a new directory.

### ⑤ PATH

Indicates the name of the current directory. Press the arrow button to move to the next higher level. If the current directory is the top level, the arrow button is dimmed.

### ⑥ VOLUME NAME/FREE SIZE

Indicates the volume name and the amount of free space on the USB flash drive. If the USB flash drive is write-protected, a protect symbol will appear in the VOLUME NAME field.

### ⑦ File list

This area lists the files and sub-directories that are saved on the USB flash drive. The highlighted line indicates the file selected for operations.

The file list contains the following items. When you press an item name, it will turn orange, and the list will be sorted by that item. Each time you press the item name, the sorting order will alternate between ascending and descending order.

- **FILE NAME**..... Indicates the file name or directory name, and shows an icon indicating its type.
- **COMMENT** ..... The comment added to the QL console setting file is displayed here. You can press this area to open a keyboard window, allowing you to enter a comment for the file.
- **READ ONLY** ..... A lock symbol in this column indicates that the corresponding file is protected. You can press this area to enable or disable the protect setting. Protected files cannot be overwritten.
- **TYPE**..... Indicates the file type.  
ALL: File containing QL internal settings  
KEY: User authentication key  
XML: Help file  
BMP: Bitmap image file  
MP3: MP3 file  
[DIR]: Directory
- **TIME STAMP** ..... Indicates the date and time at which the file was modified most recently.

### ⑧ File selection knob

Selects a file on the file list. You can operate this knob using the [TOUCH AND TURN] knob.

### ⑨ SAVE button

Saves all of the QL console internal settings together ([page 179](#)).

### ⑩ LOAD button

Loads the selected QL setting file ([page 180](#)).

### ⑪ CREATE USER KEY button

Creates a user authentication key ([page 160](#)).

### ⑫ FORMAT button

Initializes the USB flash drive ([page 183](#)).

### ⑬ WITH DANTE SETUP AND I/O DEVICE button

If this is off, the DANTE SETUP and I/O device settings as well as word clock settings will be omitted when a settings file is loaded.

### NOTE

The DANTE SETUP settings SECONDARY PORT and CONSOLE ID will not be changed even if the WITH DANTE SETUP AND I/O DEVICE button is on.

## Saving the QL console's internal data on a USB flash drive

All of the QL series console's internal data can be saved on a USB flash drive as a setting file. The saved file will have an extension of ".CLF."

### STEP

1. In the SAVE/LOAD window, press the SAVE button.
2. In the SAVE SELECT screen, select the data to be saved, the data type, and the save destination.
3. In the SAVE SELECT screen, press the SAVE button.
4. Enter a file name and comment.
5. Press the SAVE button to execute the Save operation.

### SAVE SELECT screen

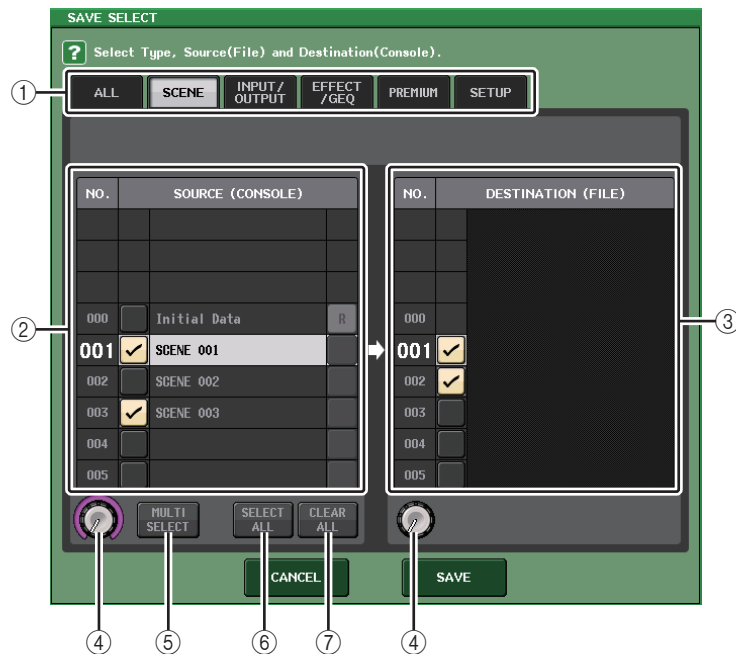

#### ① TYPE field

Specifies the types of data to be saved. The view of the TYPE field will vary depending on the tab you select.

- **ALL tab**  
This button selects all the items.
- **SCENE tab**  
This button selects scene memories.

#### • INPUT/OUTPUT tab

The following table lists the items that you can select.

Button	Data content
IN CH LIB	Input channel library
OUT CH LIB	Output channel library
IN EQ LIB	Input EQ library
OUT EQ LIB	Output EQ library
DYNA LIB	Dynamics library

#### • EFFECT/GEQ tab

The following table lists the items that you can select.

Button	Data content
EFFECT LIB	Effect library
GEQ LIB	GEQ library

#### • PREMIUM tab

The following table lists the items that you can select.

Button	Data content
5033 LIB	Portico 5033 library
5043 LIB	Portico 5043 library
U76 LIB	U76 library
Opt-2A LIB	Opt-2A library
EQ-1A LIB	EQ-1A library
DynaEQ LIB	DynamicEQ library

#### • SETUP tab

The following table lists the items that you can select.

Button	Data content
MIXER SETUP	Mixer setup
OUTPUT PORT	Output port
MONITOR	CUE/MONITOR/OSCILLATOR/TALKBACK
MIDI SETUP	MIDI setup
MIDI PGM	MIDI program changes
MIDI CTL	MIDI control changes
Dante In Patch	Dante input patch library

#### NOTE

When the output port items are saved individually, channel assignments for the port will not be saved. To prevent this, save the scene that contains input/output patching for the channel assignment as well.

② **SOURCE field**

Indicates the internal data of the QL series console.

③ **DESTINATION field**

Indicates the save destination.

④ **Data selection knob**

This knob selects the data shown in the field.

⑤ **MULTI SELECT button**

Press this button to make a selection containing multiple items of data.

⑥ **SELECT ALL button**

Press this button to select all items.

⑦ **CLEAR ALL button**

Press this button to clear all selections.

**NOTE**

- To select a different directory as a save destination, in the SAVE/LOAD window, press a directory icon or press the arrow button in the PATH field.
- If you are going to overwrite a file or save a file with the same name in the same folder, a dialog will ask you to confirm the overwrite.
- You can enter a comment of up to 32 characters.
- You may enter a file name of more than eight characters. However, the drive name, path name, and file name are limited to a total of 256 characters. If you exceed this limit, you may be unable to save the file, depending on the length of the file name. If this error indication appears at the bottom of the screen, shorten the file name and try saving the file again.

**Loading a file from a USB flash drive**

Follow the steps below to load a QL settings file (extension .CLF) from the USB flash drive into the QL series console.

You can use the same procedure to load the following files as well as settings files.

Extension	Type	Contents of file
.CLF	ALL	QL console internal setting file
.CLU	KEY	QL console user authentication key
.XML	XML	XML file for displaying Help
.TXT	TEXT	Text file for displaying Help
.BMP	BMP	Image file for display in the CONSOLE LOCK screen (256 or more colors, uncompressed bitmap format)

**NOTICE**

Some data may contain settings that will cause the console to output signals immediately after the data is loaded. Before you load, turn off the power of the equipment connected to the QL series console and/or lower the volume of such equipment so that there will not be a problem even if a signal is output from the QL console.

**NOTE**

- When the file has finished being loaded, the window that shows the progress of the loading operation and the type of data will close. If you cancel this procedure while it is in progress, data up to the cancellation point will still be loaded.
- Some setting data may not be loaded, depending on the USER LEVEL setting during the load operation.

**STEP**

1. To select the file that you want to load, press the name of the desired file in the file list in the SAVE/LOAD window, or rotate the [TOUCH AND TURN] knob.
2. If you want the DANTE SETUP and I/O device-related settings saved in the QL settings file (file name extension .CLF) and the word clock settings to be applied to the QL console, press the [WITH DANTE SETUP AND I/O RACK] button to turn it on.
3. In the SAVE/LOAD window, press the LOAD button.
4. In the LOAD SELECT screen, select the data to load, the data type, and the load destination.
5. Press the LOAD button to load the selected file.

## LOAD SELECT screen

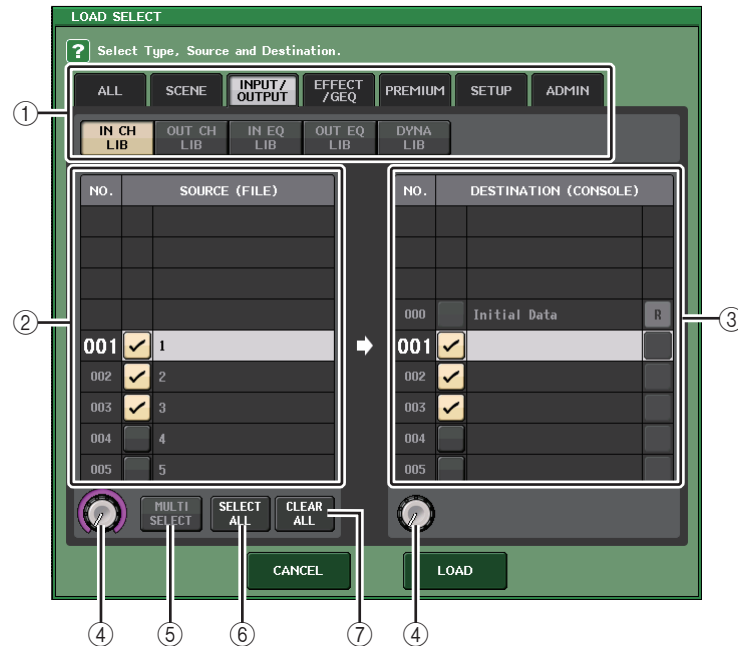

### ① TYPE field

Indicates the type of data to be loaded. The view will vary depending on the tab you select.

- **ALL tab**

This button selects all the items.

- **SCENE tab**

This button selects scene memories.

- **INPUT/OUTPUT tab**

The following table lists the items that you can select.

Button	Data content
IN CH LIB	Input channel library
OUT CH LIB	Output channel library
IN EQ LIB	Input EQ library
OUT EQ LIB	Output EQ library
DYNA LIB	Dynamics library

- **EFFECT/GEQ tab**

The following table lists the items that you can select.

Button	Data content
EFFECT LIB	Effect library
GEQ LIB	GEQ library

- **PREMIUM tab**

The following table lists the items that you can select.

Button	Data content
5033 LIB	Portico 5033 library
5043 LIB	Portico 5043 library
U76 LIB	U76 library
Opt-2A LIB	Opt-2A library
EQ-1A LIB	EQ-1A library
DynaEQ LIB	DynamicEQ library

- **SETUP tab**

The following table lists the items that you can select.

Button	Data content
MIXER SETUP	Mixer setup
OUTPUT PORT	Output port
MONITOR	CUE/MONITOR/OSCILLATOR/TALKBACK
MIDI SETUP	MIDI setup
MIDI PGM	MIDI program changes
MIDI CTL	MIDI control changes
Dante In Patch	Dante input patch library

### NOTE

When the output port items are loaded individually, channel assignments for the port will not be applied. To prevent this, load and then recall the scene that contains input/output patching for the channel assignment.

- **ADMIN tab**

The following table lists the items that you can select.

Type	Data content
ADMIN PREF	PREFERENCE (for the Administrator)
ADMIN UDEF	USER DEFINED KEYS/USER DEFINED KNOBS (for the Administrator)
ADMIN FADER	CUSTOM FADER BANK (for the Administrator)
GUEST PREF	PREFERENCE (for the Guest)
GUEST UDEF	USER DEFINED KEYS/USER DEFINED KNOBS (for the Guest)
GUEST FADER	CUSTOM FADER BANK (for the Guest)
GUEST LEVEL	USER LEVEL (for the Guest)

② **SOURCE field**

This area lists the data that is saved on the USB flash drive.

③ **DESTINATION field**

Indicates the load destination.

④ **Data selection knob**

This knob selects the data shown in the field.

⑤ **MULTI SELECT button**

Press this button to make a selection containing multiple items of data.

⑥ **SELECT ALL button**

Press this button to select all items.

⑦ **CLEAR ALL button**

Press this button to clear all selections.

## Editing the files saved on the USB flash drive

Follow the steps below to perform editing operations such as sorting the files and directories on the USB flash drive, editing the file names or comments, copying, and pasting.

### ■ Sorting files

To sort the files, press one of the headings “FILE NAME,” “COMMENT,” “READ ONLY,” “TYPE,” or “TIME STAMP” at the top of each column on the SAVE/LOAD window. The list will be sorted as follows, according to the column heading you press.

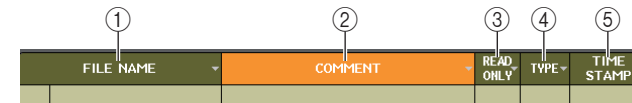

① **FILE NAME**

Sort the list in numerical/alphabetical order of the file names.

② **COMMENT**

Sort the list in numerical/alphabetical order of the comment.

③ **READ ONLY**

Sort the list by Write Protect on/off status.

④ **TYPE**

Sort the list by file type.

⑤ **TIME STAMP**

Sort the list by date and time of update.

#### NOTE

By pressing the same location again, you can change the direction (ascending order or descending order) in which the list is sorted.

## ■ Editing file names/comments

### STEP

1. In the SAVE/LOAD window, press the FILE NAME field or COMMENT field of each file.
2. Enter a file name or comment in the keyboard window, and press the RENAME button or SET button.

### NOTE

You cannot edit the file name or comment of a write-protected file.

## ■ Copying and pasting a file

Follow the steps below to copy a desired file into buffer memory, and then paste it with a different file name.

### STEP

1. Turn the [TOUCH AND TURN] knob to select the copy-source file, and press the COPY button in the SAVE/LOAD window.
2. Press the directory icon or press the arrow button in the PATH field to move to the directory into which you want to paste the file.
3. Press the PASTE button.
4. Enter the file name, and press the PASTE button.

### NOTE

You cannot use a file name that already exists when you paste a file.

## ■ Deleting a file

### STEP

1. Turn the [TOUCH AND TURN] knob to select a file to delete, then press the DELETE button in the SAVE/LOAD window.
2. To execute the Delete operation, press the OK button.

### NOTE

You cannot delete a protected file.

## ■ Creating a directory

### STEP

1. Press the directory icon or press the arrow button in the PATH field in the SAVE/LOAD window to change the directory.
2. Press the MAKE DIR button.
3. Enter the name of the directory you want to create, then press the MAKE button.

### NOTE

You cannot create a directory using a directory name that already exists.

## Formatting a USB flash drive

Follow the steps below to format a USB flash drive.

A USB flash drive with a capacity of 4GB or larger will be formatted in FAT32, and a USB flash drive with a capacity of 2GB or smaller will be formatted in FAT16.

### STEP

1. In the Function Access Area, press the SETUP button.
2. In the SETUP screen, press the SAVE/LOAD button.
3. In the SAVE/LOAD window, press the FORMAT button.
4. Enter a volume name, and press the FORMAT button.
5. To execute the Format operation, press the OK button.



SAVE/LOAD window



## Recovering after overcurrent at the USB port

Even if the connection with the USB device was stopped because an overcurrent condition occurred at the USB port, it is possible to use the USB device again without turning the console power off and back on.



### Recovery procedure

After removing the cause of the overcurrent at the USB port, press the location that shows “USB REMOUNT” at the FORMAT button of the SAVE/LOAD window.

## Word clock and slot settings

“Word clock” refers to the clock that provides the basis of timing for digital audio signal processing. To send and receive digital audio signals between devices, those devices must be synchronized to the same word clock. If digital audio signals are transferred in an unsynchronized state, the data may not be transmitted or received correctly, and noise may be present in the signal, even if the sampling rates are the same.

Specifically, you must first decide which device will transmit the reference word clock for the entire system (the word clock master), and then set the remaining devices (the word clock slaves) so that they synchronize to the word clock master.

If you wish to use the QL series console as a word clock slave that is synchronized to the word clock supplied from an external device, you must specify the appropriate clock source (the port through which the word clock is obtained).

This section explains how to select the clock source that the QL series console will use.

### STEP

1. In the Function Access Area, press the SETUP button.
2. In the SYSTEM SETUP field of the SETUP screen, press the WORD CLOCK/SLOT button.
3. In the MASTER CLOCK SELECT field of the WORD CLOCK/SLOT window, select a clock source.
4. Press the “x” symbol located in the upper right to close the window.



SETUP screen



WORD CLOCK/SLOT window

## WORD CLOCK/SLOT window

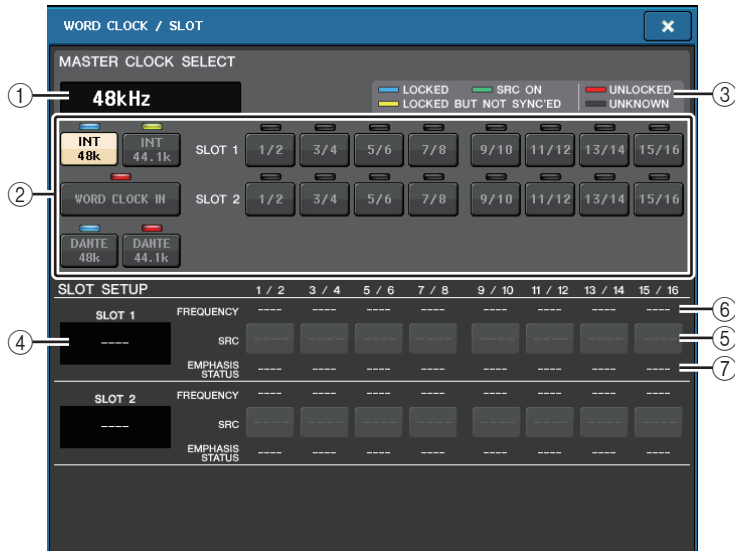

### MASTER CLOCK SELECT field

#### ① Master clock frequency display

Indicates the frequency (44.1 kHz or 48 kHz) of the currently-selected master clock. If the unit is not synching to the master clock, “UNLOCK” will appear.

#### NOTE

- If sample rate pull-up/down has been specified in the Dante Controller application, this area indicates the change in the sample rate as a percentage, such as  $-4.0\%$ ,  $-0.1\%$ ,  $+4.0\%$ ,  $4.1667\%$ , etc.
- To change the master clock when sample rate pull-up/down has been specified, disable the pull-up/down in the Dante Controller, change the master clock, then specify pull-up/down again.

48kHz -4.0%

#### ② Master clock select buttons

Use the buttons to select the clock source that you want to use as the word clock master from the following options:

- INT 48 k**
- INT 44.1 k**  
The QL console internal clock (sampling rate 48 kHz or 44.1 kHz) will be the clock source.
- WORD CLOCK IN**  
The word clock supplied from the WORD CLOCK IN jack on the rear panel of the console will be used as the clock source.

- DANTE 48k**
- DANTE 44.1k**  
The word clock supplied from the Dante jack on the rear panel of the console will be used as the clock source.
- SLOT 1–2**  
The word clock supplied via a digital I/O card installed in a console slot will be used as the clock source. Word clock can be selected in pairs for each slot.
- ③ **Clock status display**  
Indicates the status of synchronization with the master clock for each clock source. Each indicator is explained below:
  - LOCKED (light blue)**  
Indicates that a clock synchronized with the selected clock source is being input. If an external device is connected to the corresponding connector or slot, input/output is occurring properly between that device and the QL series console. If the sampling frequency is close, this status may be displayed even if not synchronized.
  - LOCKED, BUT NOT SYNC'ED (yellow)**  
A valid clock is being input, but is not synchronized with the selected clock source. If an external device is connected to the corresponding connector, input/output cannot occur correctly between that device and the QL series console.
  - SRC ON (green)**  
This is a special status that applies only to SLOT1–2, indicating that the corresponding channel's SRC (Sampling Rate Converter) is enabled. This means that even if the signal is not synchronized, normal input/output with the QL series console is occurring.
  - UNLOCKED (red)**  
A valid clock is not being input. If an external device is connected to the corresponding connector, input/output cannot occur correctly between that device and the QL series console.
  - UNKNOWN (black)**  
This indicates that the clock status cannot be detected because no external device is connected or because there is no valid clock input. You will be able to select this connector/slot, but successful synchronization cannot occur until a valid connection is established.

#### NOTE

- If the indicator for the selected clock does not turn light blue, make sure that the external device is correctly connected, and that the external device is set to transmit clock data.
- Noise may occur at the output jacks when the word clock setting is changed. To protect your speaker system, be sure to turn down the power amp volume before changing the word clock setting.
- If you attempt to select a channel (for which SRC is on) as the word clock source, a message will appear, warning you that the sampling rate converter will be disabled.

## ■ SLOT field

This field enables you to make various settings related to the MY slots on the rear panel of the console.

### ④ Card name

Indicates the type of card installed in the slot. If nothing is installed, "----" will appear.

### ⑤ SRC buttons

The SRC (Sampling Rate Converter) function can be switched on or off for a slot in which an MY card (MY8-AE96S) that features the SRC function is installed. If another type of card is installed, or if no card is installed, no SRC button will appear.

### ⑥ FREQUENCY display

Indicates the sampling frequency of input signals if the installed card can detect the substatus of input signals, such as an AES/EBU card. If another type of card is installed, or if no card is installed, "----" will appear.

### ⑦ EMPHASIS STATUS display

Indicates the emphasis information of input signals if the installed card can detect the substatus of input signals, such as an AES/EBU card. If another type of card is installed, or if no card is installed, "----" will appear.

## Using cascade connections

Using multiple QL series consoles, or a QL console and an external mixing console (such as a Yamaha PM5D) in a cascade connection enables buses to be shared among the devices. This can be convenient if you want to use an external mixer to increase the number of inputs.

This section explains cascade connections and operation, using an example in which two QL units are connected in a cascade configuration.

### About cascade connections

To cascade two QL series consoles, you must first install digital I/O cards in the appropriate slots, and connect the output ports of the sending unit (the cascade slave) to the input ports of the receiving unit (the cascade master).

The following illustration shows an example in which two eight-channel digital I/O cards for each unit are installed in the cascade slave QL unit and in the cascade master QL unit. The DIGITAL OUT jacks of the sending unit are connected to the DIGITAL IN jacks of the receiving unit.

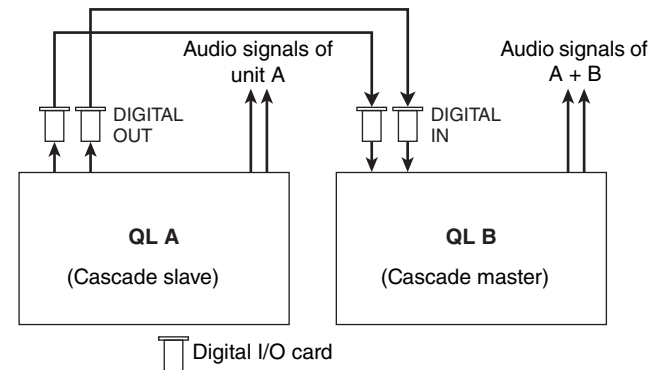

In this example, up to twenty four buses chosen from MIX bus 1–16, MATRIX bus 1–8, STEREO bus (L/R), MONO (C) bus, and CUE bus (L/R) can be shared, and the mixed signals transmitted from the cascade master QL unit. (If you use two 16-channel digital I/O cards, all buses can be shared among the devices.) When the required settings are made for the cascade slave and for the cascade master, the bus signals of the cascade slave will be sent via the slot to the buses of the cascade master, and the combined signals of both buses will be output from the cascade master. If the Cascade Link function is enabled, the specified operations or parameter changes performed on either QL series console will be followed by the other QL console.

You must specify bus assignments for each slot or channel on each QL unit. Separate procedures are outlined for the cascade slave and the cascade master.

**NOTE**

- If you are making a cascade connection between the QL unit and the PM5D, you can use the QL unit as the cascade slave by setting the PM5D's CASCADE IN PORT SELECT to a slot. However, only the audio signals will be cascaded, and the control signals cannot be linked.
- You can also use an AD/DA card or OMNI OUT jack to make cascade connections with an analog mixer.
- There is no limit to the number of units that can be cascade-connected, but the signal delay at the cascade slave will increase in accordance with the number of units from the cascade master.

**Operations on a cascade slave QL unit****STEP**

1. In the Function Access Area, press the SETUP button.
2. In the SYSTEM SETUP field of the SETUP screen, press the CASCADE button.
3. In the CASCADE window, press the CASCADE OUT PATCH tab.
4. In the CASCADE OUT PATCH page, press the OUT PATCH button for the bus to which you want to assign the port.
5. Use the category select list and the port select buttons to select the slot and output port that you want to assign, and then press the CLOSE button.
6. In the CASCADE COMM PORT field, select the port that will transmit and receive control signals for cascade link.
7. Use the CASCADE LINK MODE buttons to select the item that you want to link.

**NOTE**

- You cannot assign two or more buses to the same output port. If you select a port to which a signal route has already been assigned, the previous assignment will be canceled.
- Control signals for the cascade link and MIDI messages cannot share the same port. If you select a port that is already specified for transmission/reception of MIDI messages, a dialog box will ask whether it is OK to cancel the existing settings.

**CASCADE window (CASCADE OUT PATCH page)**

You can select the slot and output port that will output each bus.

**① Port select popup buttons (CASCADE OUT PATCH section)**

Enable you to select the output port for cascade connections for each of MIX 1–16, MATRIX 1–8, STEREO L/R, MONO, and CUE L/R buses. Press the button to open the PORT SELECT window, in which you can select a port.

**② CASCADE LINK MODE buttons**

Specify whether only cue operations will be linked, or all linkable operations including scene store/recall operations will also be linked when QL series consoles are cascade-connected.

- **OFF**  
No link operation
- **CUE**  
The following cue-related parameters and events will be linked.
  - Cue enable/disable
  - Cue mode (MIX CUE or LAST CUE)
  - Cue point settings for input channels and output channels
- **ALL**  
All linkable parameters and events (including cue-related parameters) will be linked.
  - Cue-related parameters and events (see above)
  - Scene recall operations

- Scene store operations
- DIMMER (MONITOR screen) operations
- Panel LED and display brightness (SETUP screen) operations
- Master mute group operations

### ③ CASCADE COMM PORT buttons

Specify the communication port used for transmitting and receiving link information when operations such as cue and scene store/recall are linked between cascade-connected QL series consoles.

- **NONE**.....No link operation
- **MIDI**.....Use MIDI port
- **SLOT1** .....Use SLOT1

### ④ Tabs

Enable you to switch between items.

## PORT SELECT window

Press the OUT PATCH button to open this window.

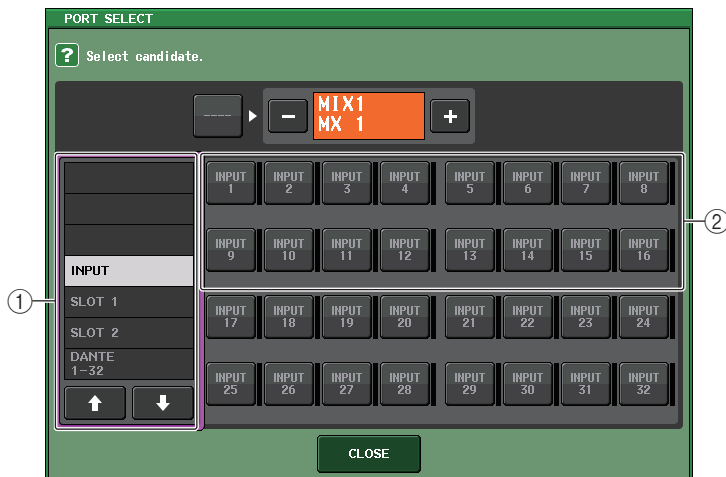

### ① Category select list

Selects the port (slot 1–2) that will be shown on the screen.

### ② Port select buttons

Within the specified slot, these buttons select the ports that will be patched.

## Operations on the cascade master QL unit

### STEP

1. In the Function Access Area, press the SETUP button.
2. In the SYSTEM SETUP field of the SETUP screen, press the CASCADE button.
3. In the CASCADE window, press the CASCADE IN PATCH tab.
4. In the CASCADE IN PATCH page, press the IN PATCH button for the bus to which you want to assign the port.
5. In the PORT SELECT screen, use the category select list and the port select buttons to select the slot and input ports that you want to assign, and then press the CLOSE button.
6. As described in step 6 of “Operations on a cascade slave QL unit” on page 187, in the CASCADE LINK PORT field, select the port that will transmit and receive control signals for cascade link.
7. As described in step 7 of “Operations on a cascade slave QL unit” on page 187, in the CASCADE COMM LINK field, select the same item as the cascade slave.

### NOTE

- You can assign the same input port to two or more buses.
- Control signals for the cascade link and MIDI messages cannot share the same port. If you select a port that is already specified for transmission/reception of MIDI messages, a dialog box will ask whether it is OK to cancel the existing settings.

## Basic settings for MIX buses and MATRIX buses

Follow the steps below to change the basic settings for MIX buses and MATRIX buses, such as switching between stereo and monaural, and selecting the send point from which the signal of an input channel will be sent. The settings you make in the following procedure are saved as part of the scene.

### STEP

1. In the Function Access Area, press the **SETUP** button.
2. In the **SETUP** screen, press the **BUS SETUP** button.
3. Use the tabs in the **BUS SETUP** window to select the buses whose settings you want to edit.
4. Use the **SIGNAL TYPE** switch buttons to specify whether each bus will function as **STEREO** (main parameters will be linked for two adjacent odd-numbered/even-numbered buses) or **MONOx2** (use as two monaural channels).
5. Use the bus type/send point select buttons to select the bus type and the position from which the signal of the input channel will be sent.
6. As desired, turn the buttons in the **PAN LINK** field on or off.



SETUP screen

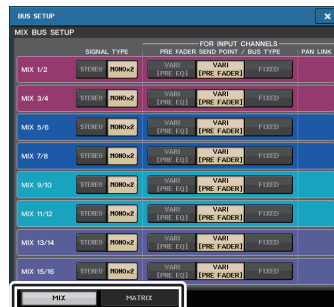

BUS SETUP window

## BUS SETUP window

You can make various settings for MIX buses and MATRIX buses.

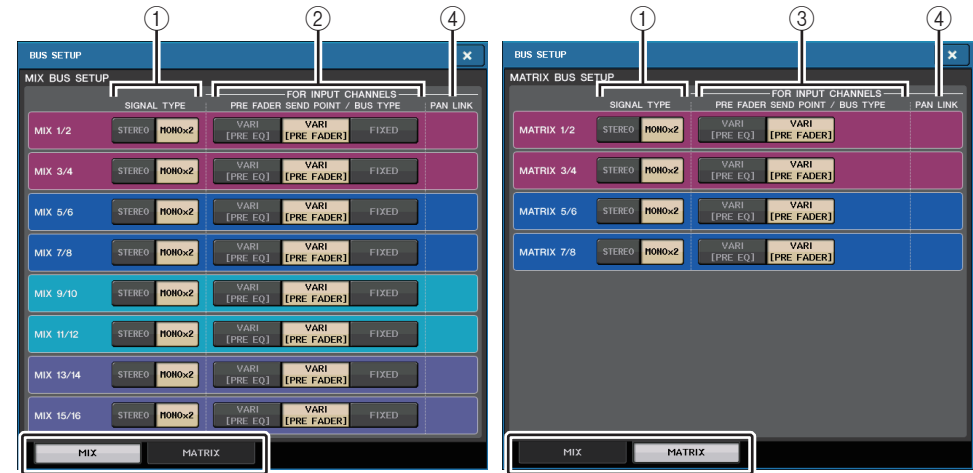

5

MIX page

5

MATRIX page

- 1 **SIGNAL TYPE** switch buttons  
Select how signals are processed for every adjacent pair of buses. Select either **STEREO** (stereo signal) or **MONOx2** (monaural signal x 2).
  - 2 **Bus type/send point** select buttons (**MIX bus only**)  
For every adjacent pair of buses, you can select the bus type and (for vari-type) the send point. These buttons correspond to the following parameters.
- | Button           | Bus type | Pre-fader send point         |
|------------------|----------|------------------------------|
| VARI [PRE EQ]    | VARI     | Immediately before the EQ    |
| VARI [PRE FADER] | VARI     | Immediately before the fader |
| FIXED            | FIXED    | ---                          |
- 3 **Send point** select buttons (**MATRIX bus only**)  
Select the pre-fader send point from the input channel. These buttons correspond to the following parameters.
- | Button    | Pre-fader send point         |
|-----------|------------------------------|
| PRE EQ    | Immediately before the EQ    |
| PRE FADER | Immediately before the fader |

#### ④ PAN LINK button

This button appears if SIGNAL TYPE is set to STEREO and the bus type is set to VARI. If the button is on, the pan setting of signals sent from input channels to the corresponding two buses will link with the STEREO bus pan setting.

#### ⑤ Tabs

Enable you to switch between the MIX and MATRIX buses.

## Switching the entire phantom power supply on/off

### STEP

1. In the Function Access Area, press the **SETUP** button to access the **SETUP** screen.
2. In the center of the **SETUP** screen, press the **+48V MASTER** field's **ON** button or **OFF** button.  
If this button is off, phantom power will not be supplied even if the +48V button of an OMNI jack input channel or TALKBACK IN is on.



SETUP screen

### NOTE

This +48V MASTER setting does not affect the inputs of external racks such as DANTE inputs (I/O devices). Each rack has a +48V MASTER switch, and will operate according to its setting.

## Specifying the brightness of the touch screen, LEDs, channel name displays, and lamps

Follow the steps below to specify the brightness of the touch screen, top panel LEDs, channel name displays, and lamps connected to the rear panel LAMP connectors. You can save two different brightness settings in bank A and B, and switch between them rapidly if desired.

### STEP

1. In the Function Access Area, press the **SETUP** button.
2. In the field located in the right of the bottom row of the **SETUP** screen, press the **BANK A** or **BANK B** button.
3. Use the **[TOUCH AND TURN]** knob to adjust the brightness of each item.

### NOTE

You can also assign this parameter to a **USER DEFINED** key, and press that key to switch between banks A and B.

### SETUP screen (brightness setting field)

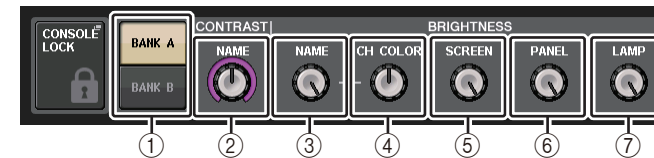

- ① **BANK A/B buttons**  
Switch between the brightness settings.

### ■ CONTRAST field

- ② **NAME**  
Adjusts the contrast of the characters of the channel name displays on the top panel.

### ■ BRIGHTNESS field

- ③ **NAME**  
Adjusts the brightness of the channel name displays on the top panel. This will also change the CH COLOR brightness and LED brightness in the lower part of the **[TOUCH AND TURN]** knob. If you want to adjust the CH COLOR brightness after setting the name display brightness, use the CH COLOR knob.
- ④ **CH COLOR**  
Adjusts the brightness of the channel colors on the top panel. This lets you apply a relative adjustment to only the channel color brightness without changing the channel name display brightness.



⑤ **SCREEN**

Adjusts the brightness of the touch screen.  
If the brightness is set to lower than level 2, the QL will start up next time with a brightness setting of 2 so that you will be able to see the screen.

⑥ **PANEL**

Adjusts the brightness of the top panel LEDs.

**NOTE**

If the AD8HR is connected, the brightness of the AD8HR's LEDs will also change.

⑦ **LAMP**

Adjusts the brightness of the lamps connected to the rear panel LAMP jacks.

## Setting the date and time of the internal clock

This section explains how to set the date and time of the QL console's internal clock, and how to select the date and time display format. The date and time you specify here will affect the time stamp used when saving a scene.

**STEP**

1. In the Function Access Area, press the **SETUP** button.
2. Press the **DATE/TIME** button at the lower part of the **SETUP** screen.
3. In the **FORMAT** field of the **DATE/TIME** window, press the **MODE** buttons several times to select the desired format for date and time display.
4. Use the **[TOUCH AND TURN]** knob to set the current date and time.
5. When you have finished making settings, press the **OK** button.

### DATE/TIME window

Press the **DATE/TIME** button in the **SETUP** screen to open this window.

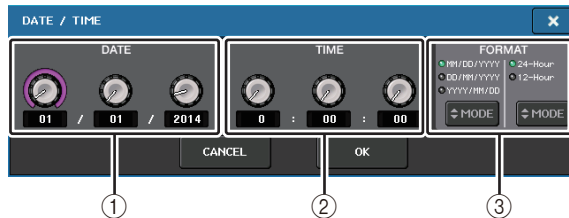
① **DATE**

Specifies the date of the internal clock.

② **TIME**

Specifies the time of the internal clock.

③ **FORMAT (Display format)**

Specifies the format in which the date and time of the internal clock are displayed.  
You can select from the following display formats.

- **Date**  
MM/DD/YYYY (Month/Day/Year)  
DD/MM/YYYY (Day/Month/Year)  
YYYY/MM/DD (Year/Month/Day)
- **Time**  
24-Hour (hours shown in the range of 0–23)  
12-Hour (hours shown from 0am–11am, and 0pm–11pm)

## Setting the network address

This section explains how to set the network address that will be required when you use the **NETWORK** connector on the QL series console to connect it to a computer.

If you plan to connect the QL series console to your computer in a one-to-one connection, we recommend that you use the following default values. Make sure that the IP address and Gateway address do not match the addresses of any other device on the network.

**IP Address:** 192.168.0.128 or similar

**Gateway address:** 192.168.0.1 or similar

**Subnet mask:** 255.255.255.0 or similar

**NOTE**

- Only the Administrator can change network settings.
- For details on settings related to connecting to a LAN, refer to the QL Editor Installation Guide.

**STEP**

1. In the Function Access Area, press the **SETUP** button.
2. Press the **NETWORK** button at the lower part of the **SETUP** screen.
3. Press and select the knobs in the **NETWORK** window to specify the address using the **[TOUCH AND TURN]** knob.
4. When you have finished making settings, press the **OK** button.
5. Restart the QL series console.

## NETWORK window



### ① IP ADDRESS

Specifies an address that identifies an individual device on the Internet or LAN network.

### ② GATEWAY ADDRESS

Specifies an address that identifies a device (gateway) that converts data between different media or protocols to allow communication within the network.

### ③ SUBNET MASK

Within the IP address used in the network, this defines the bits that are used for the network address that distinguishes the network.

### ④ MAC ADDRESS

Indicates the MAC (Machine Access Control) address, which identifies a host in a network. This address is for display only, and cannot be edited.

### NOTE

The NETWORK connector on the QL series console transmits data via either 100BASE-TX (transmission speed: maximum 100 Mbps) or 10BASE-T (transmission speed: max 10 Mbps).

## Setting up the Dante audio network

You will use the QL series console to make Dante audio network settings for the console itself and the I/O devices connected to the Dante connector of the QL series console. This section explains how to make Dante audio network settings.

### STEP

1. In the Function Access Area, press the **SETUP** button to access the **SETUP** screen.
2. In the **DANTE** field at the center of the screen, press the **DANTE SETUP** button to open the **DANTE SETUP** window.
3. Press the **SETUP** tab in the lower part of the **DANTE SETUP** window.



SETUP screen



DANTE SETUP window

## DANTE SETUP window (SETUP page)

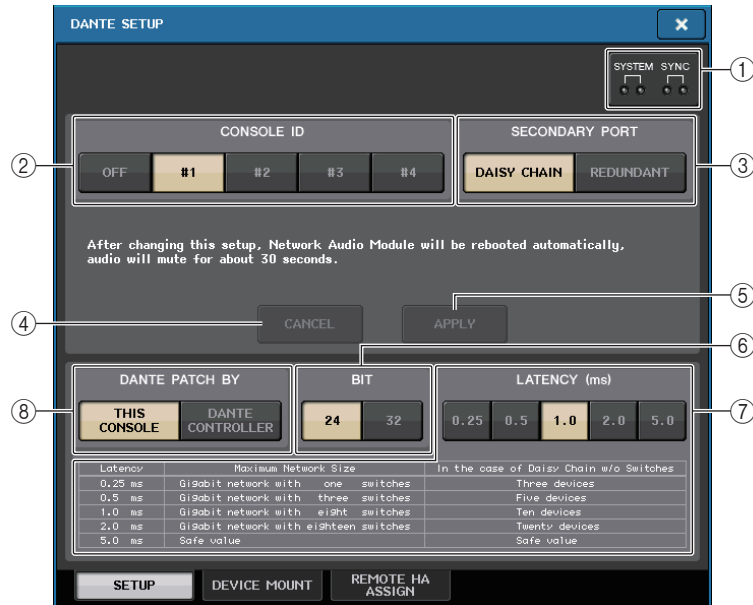

### ① STATUS indicators

Show the operating status of the QL series console and the Dante network.

### ② CONSOLE ID select buttons

Set the IDs for the QL series consoles.

If five or more QL units are connected to a network, and you plan not to assign IDs to some of the units, press the OFF button of each of those units to turn off the ID.

### ③ SECONDARY PORT select buttons

Specify how the Dante audio network is configured.

### ④ CANCEL button

When editing the CONSOLE ID or SECONDARY PORT settings, you can press this button to cancel the changes you made.

### ⑤ APPLY button

After changing the CONSOLE ID or SECONDARY PORT settings, press this button to apply the changes you made.

### ⑥ BIT select buttons

Enable you to set the audio bit depth to 24-bit or 32-bit.

- **24bit**..... Use this when transmitting and receiving data to or from an Rio unit. When using a QL series system, you will normally use this setting.
- **32bit**..... This is effective when transmitting and receiving 25-bit or larger data (when using cascade or gain compensation), but the amount of data being transmitted will increase 20–30% compared to 24-bit.

### ⑦ LATENCY select buttons

Enable you to set the Dante audio network latency to 0.25 ms, 0.5 ms, 1.0 ms, 2.0 ms, or 5.0 ms.

The latency setting varies depending on the network connection method and size. For details, refer to “[Setting the Dante audio network latency](#)” on [page 194](#).

### ⑧ DANTE PATCH BY select buttons

Use these select buttons when using Dante Controller to make Dante patch settings.

If the THIS CONSOLE button is selected, the DANTE INPUT PATCH and DANTE OUTPUT PATCH settings can be edited from the QL series console.

If the DANTE CONTROLLER button is selected, it will not be possible to edit the Dante patch settings. You can operate these buttons regardless of the state of the DANTE PATCH BY select buttons on other QL series consoles on the network.

### NOTE

- Settings that are shared with the I/O device (BIT/LATENCY/W.CLOCK) will reflect the settings of the QL series console whose CONSOLE ID is set to #1.
- If the DANTE CONTROLLER button is selected in the DANTE PATCH BY section, and you attempt to edit the Dante patching or related settings, the message “This Operation is Not Allowed” will appear at the bottom of the screen.
- DANTE patch information is applied to the device if the QL settings file (file name extension .CLF) is loaded under the following conditions. Otherwise, the information is not applied and the current state will be maintained.
  - In the SAVE/LOAD window ([page 177](#)), the WITH DANTE SETUP AND I/O DEVICE button is on.
  - Either #1, #2, #3, or #4 CONSOLE ID select button is on.
  - The THIS CONSOLE button of the DANTE PATCH BY select buttons is on.

## Switching the CONSOLE ID and SECONDARY PORT

### STEP

1. In the DANTE SETUP window (SETUP page), select the CONSOLE ID and the SECONDARY PORT.
2. Press the APPLY button.
3. In the window to confirm the change, press the OK button.

### DANTE SETUP window (SETUP page)

The button you switched is shown in red.

When the Dante audio network settings have been applied, the button you selected will return to its original appearance.



### NOTE

- If you change the SECONDARY PORT, you must also change the method of connection between the QL series console and the I/O devices. For example if the connections used for the REDUNDANT setting are left as they are when you change the setting to DAISY CHAIN, it will become impossible to send and receive audio. Be sure to disconnect the cables before you change the setting.
- The CONSOLE ID and SECONDARY PORT settings will not be changed even if you initialize the QL series console.
- When the CONSOLE ID is OFF or is set to 2, 3, or 4 for a QL series console, the console's BIT/LATENCY will not change even if the BIT/LATENCY is changed in the DANTE SETUP window for the QL series console within a network for which the CONSOLE ID is set to 1.
- When the CONSOLE ID is set to OFF, the DANTE PATCH BY field is fixed to "DANTE CONTROLLER." Also, patching cannot be changed in the DANTE INPUT PATCH window.
- When the CONSOLE ID is set to OFF, all the mounted devices will be "virtual." You can edit HA GAIN and other settings for Rio series units, but the changes will not apply to device settings. This is the same as when the devices are not connected. Therefore, level control and other settings do not affect other devices.

### Setting the Dante audio network latency

An appropriate latency setting for signals sent and received via a Dante audio network varies depending on the network connection method and size. This section explains how to set an appropriate latency setting depending on the connection method of Dante-enabled devices that are connected to the QL series console.

#### ■ Relationship between the switches and the number of hops

An appropriate latency setting on a Dante audio network varies depending on the number of hops in the network.

One hop is the step from one router (switch) to the next. You count the number of hops starting from the master device to the most distant device (assuming that all devices are connected in series).

Switches mean network switches and routers, as well as the switches that are built into QL series consoles and I/O devices. Set the latency value based on the number of hops. The following table shows typical latency settings based on the number of hops.

Number of hops	Latency (ms)
Up to 3	0.25
Up to 5	0.5
Up to 10	1.0
Up to 20	2.0
21 or more (or if a problem occurs)	5.0

### NOTE

- Depending on network conditions, you may want to raise the latency value even if the number of hops is small.
- If a problem occurs, select 5.0 ms so that you will be able to identify whether the latency setting is the cause of the problem.

## ■ Connection examples and latency settings

### Daisy chain connections

Simple 64-in/48-out

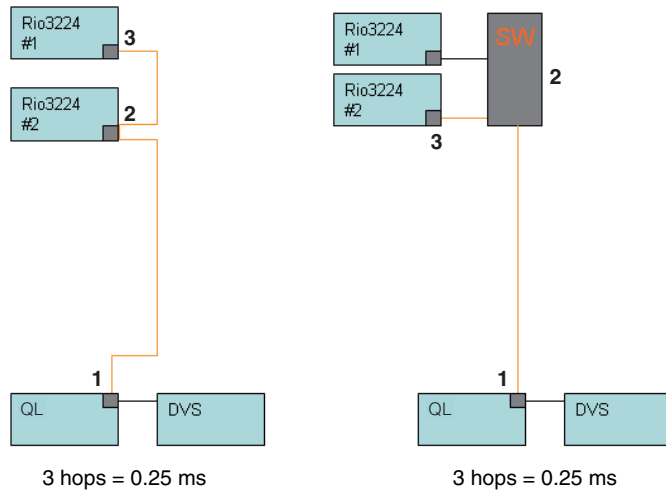

### Daisy chain connections

FOH and monitor consoles are sharing 64-in/48-out.

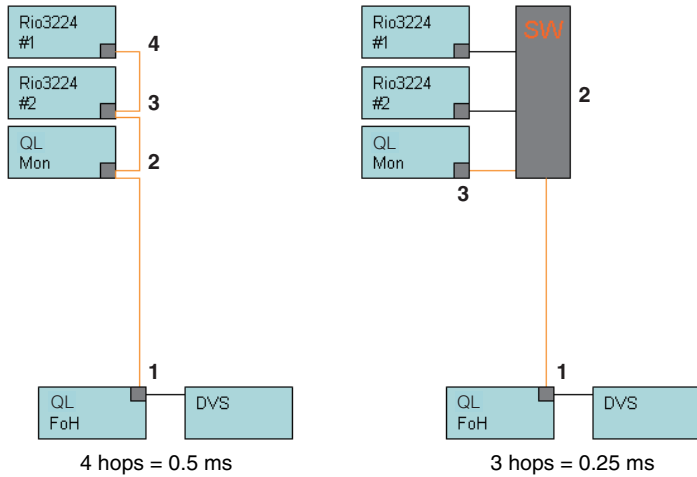

### Redundant connections

Simple 64-in/48-out

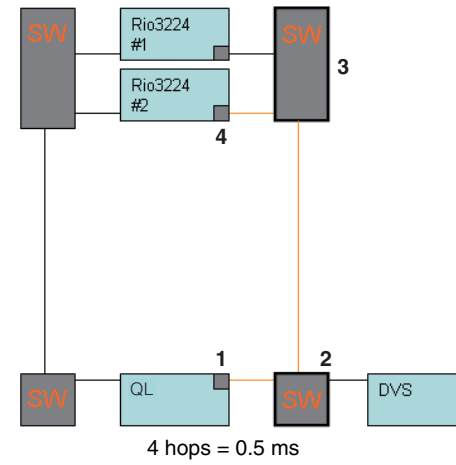

### Redundant connections

FOH and monitor consoles are sharing 64-in/48-out.

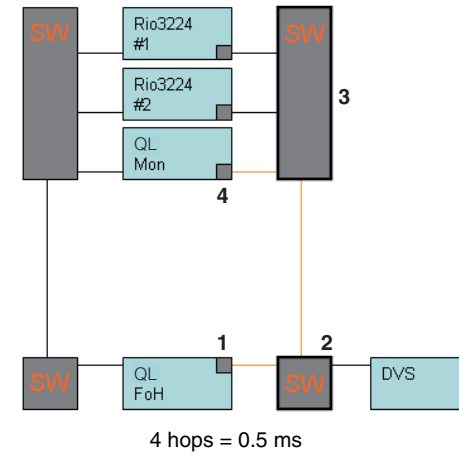

**Daisy chain connections**

256-ch HA remote (maximum size)

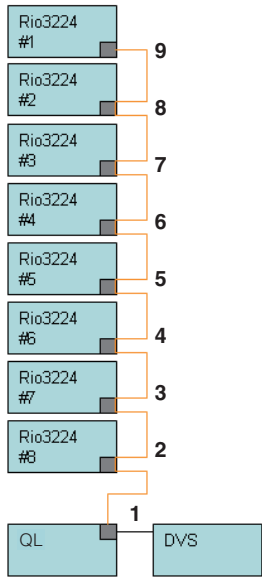

9 hops = 1.0 ms

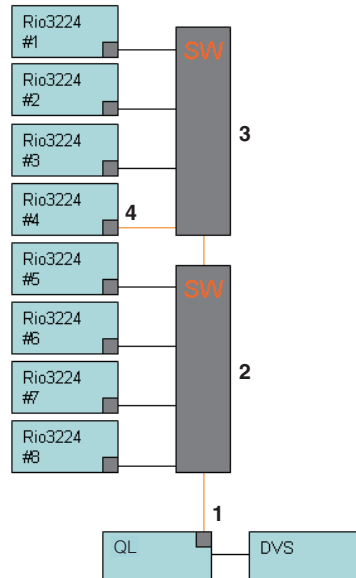

4 hops = 0.5 ms

**Redundant connections**

Two consoles are sharing 256-ch HA remote (maximum size)

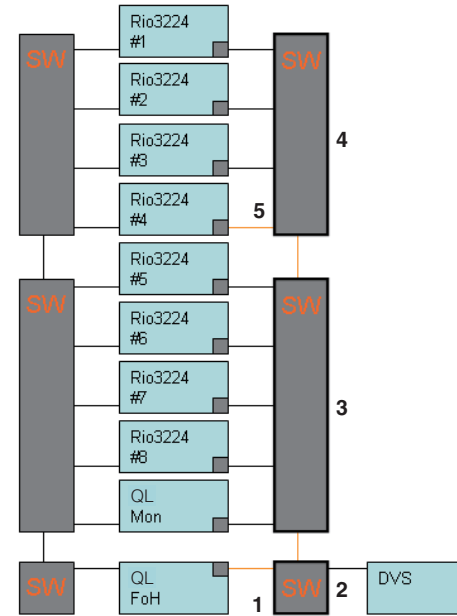

5 hops = 0.5 ms

## Mounting an I/O device on the Dante audio network

Here's how to select which of the multiple I/O devices on the Dante audio network will be mounted so that they can be used. Up to 24 units can be mounted for one QL series console.

### STEP

1. Press the DEVICE MOUNT tab in the lower part of the DANTE SETUP window.
2. Press the I/O device select button.
3. In the DEVICE SELECT window, press the setup method select button.
4. Use the [TOUCH AND TURN] knob to make settings.
5. When you have finished making settings, press the OK button to close the window.

### DANTE SETUP window (DEVICE MOUNT page)



- 1 **CLEAR ALL button**  
Clears all I/O devices in the list to an unmounted state.
- 2 **REFRESH button**  
Updates the displayed list of I/O devices on the Dante audio network.

### 3 I/O device select buttons

Press one of the buttons to open the DEVICE SELECT window. The upper line of the button shows the device label. The lower line of the button shows the model name and the number of inputs and outputs. If no device has been mounted, the upper row will indicate "---" and the lower row will show nothing.

For more information on VIRTUAL/CONFLICT/DUPLICATE shown below these buttons, refer to 1 on [page 127](#), "I/O device list."

### DANTE SETUP window

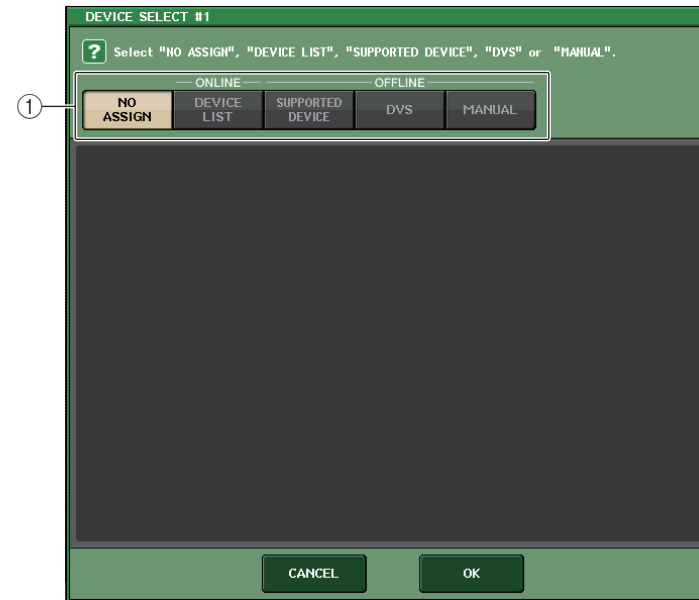

### 1 Setup method select buttons

Choose one of the following methods for mounting the I/O device.

- **NO ASSIGN** ..... Not mounted
- **DEVICE LIST** ..... Select and mount from the device list
- **SUPPORTED DEVICE** ..... Select and mount a supported device
- **DVS** ..... Enter a device label and mount (only for DVS)
- **MANUAL** ..... Enter a device label and mount



## ■ When the setup method select button is **DEVICE LIST**

To mount by choosing from a list of the I/O devices on the Dante audio network, press the **DEVICE LIST** button to display the **DEVICE LIST** field.



### ① **DEVICE LIST**

Shows a list of the I/O devices on the Dante audio network. From the list, choose the I/O device that you want to mount.

### ② **DEVICE LIST select knob**

Use the [TOUCH AND TURN] knob to select the I/O device that you want to mount.

### ③ **INPUT/OUTPUT knobs**

Use the [TOUCH AND TURN] knob to specify the number of inputs and outputs on the Dante audio network. These knobs will not be displayed when DVS is selected. If the selected I/O device is supported by the QL series, the inputs and outputs will be entered and displayed automatically.

## ■ When the setup method select button is **SUPPORTED DEVICE**

If you want to select and mount an I/O device that is supported by the QL series, press the **SUPPORTED DEVICE** button to see the **SUPPORTED DEVICE** field. These settings can be made even when not connected to a Dante audio network.

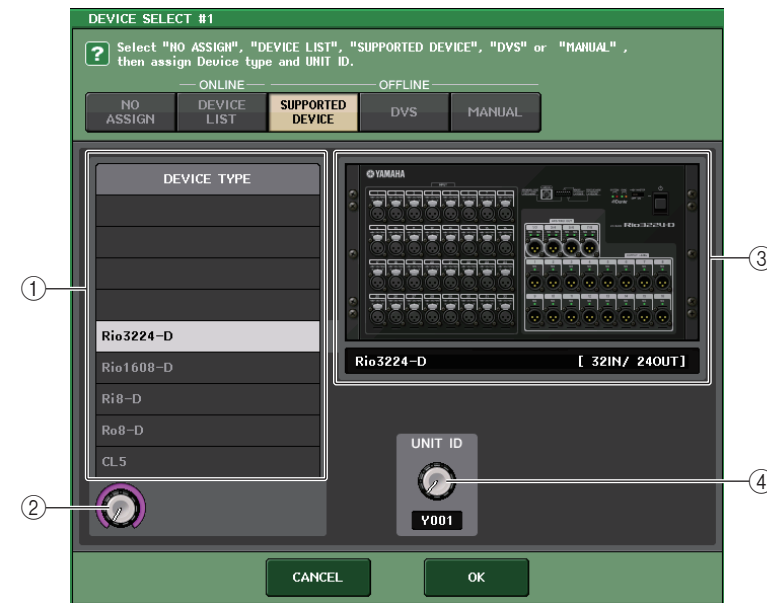

### ① **DEVICE TYPE**

This area shows a list of the I/O device types that are supported by the QL series. From the list, choose the type of I/O device that you want to mount.

### ② **DEVICE TYPE select knob**

Use the [TOUCH AND TURN] knob to select the type of I/O device that you want to mount.

### ③ **I/O device indication**

This area shows the selected I/O device.

The upper line shows the front panel of the I/O device.

The lower line shows the model name and the number of inputs and outputs.

### ④ **UNIT ID knob**

Use the [TOUCH AND TURN] knob to specify the UNIT ID.

The indicator shows the UNIT ID.

**NOTE**

- If there is one I/O device, set the I/O device's UNIT ID to "1."
- If multiple devices are connected, assign the ID numbers so that there is no conflict between devices.
- For devices other than the R series, it is possible for devices of differing models to be assigned to the same ID as an Rio series unit or the same ID as a different model of device. However, since the I/O device input/output port screen shows the UNIT ID, this will make it difficult to distinguish between the units, so we recommend that whenever possible, you avoid allowing the ID numbers to overlap.
- If you have a device whose UNIT ID or device label cannot be changed from its panel or its edit screen etc. (such as the Dante-MY16-AUD card or Dante Accelerator), and you want to use that device as a SUPPORTED DEVICE, you must change its device label via Dante Controller.
- An I/O device will be recognized as a SUPPORTED DEVICE if you assign the device label as follows.  
 Y###-\*\*\*\*\*  
 # is a three-digit hexadecimal number containing the digits 0–9 and uppercase A–F (000–FFF)  
 \* indicates any desired character (alphabetical uppercase or lowercase, numerals, or - (hyphen) may be used)
- If you are controlling the QL series console from an Rio series unit, we recommend that you set the Rio unit's START UP MODE to "REFRESH." Operation will be safer with the "REFRESH" setting, since mute will be cleared after synchronization has been completed with QL units whose system setting for REMOTE HA ASSIGN is set to "WITH RECALL."  
 With the "RESUME" setting, mute will be cleared and the unit will start operating with the settings that were backed up by the Rio series unit itself, which could allow unexpected audio to be output.
- A single QL series console can control the HA of up to eight Rio series units.  
 If nine or more Rio series units are connected, you can either divide the HA control between multiple QL series consoles, or you can omit specifying REMOTE HA ASSIGN for the Rio series units whose HA does not need to be controlled, and use them with START UP MODE set to "RESUME."

**■ When the setup method select button is DVS or MANUAL**

If you want to enter the device label of an I/O device and mount it, press the DVS or MANUAL button to access the DVS/MANUAL field.

**① DEVICE LABEL**

Displays the device label of the I/O device which you entered from the keyboard.

**② INPUT/OUTPUT knobs**

Use the [TOUCH AND TURN] knob to specify the number of inputs and outputs on the Dante audio network.

**③ Device label entry keyboard**

Use this keyboard to enter the device label of the I/O device.

**NOTE**

- If the I/O device is a DVS, mount it by pressing the DVS button.
- If DEVICE LABEL is left blank, the first DVS detected is automatically mounted.
- If the device label you entered is detected automatically, the INPUT/OUTPUT knob settings will be ignored, and the rated number of inputs and outputs will be specified.

## REMOTE HA settings

Here's how to select which of the multiple HA devices on the Dante audio network will be mounted so that they can be used. Up to 8 units can be mounted for one QL series console.

### STEP

1. Press the REMOTE HA ASSIGN tab in the lower part of the DANTE SETUP window.
2. Press a HA device select button to access the REMOTE HA SELECT window.
3. Select the HA device to mount and press the OK button.  
If you have changed the setting by pressing the WITH RECALL button, a confirmation dialog box will appear. Press the OK button.

## DANTE SETUP window (REMOTE HA page)

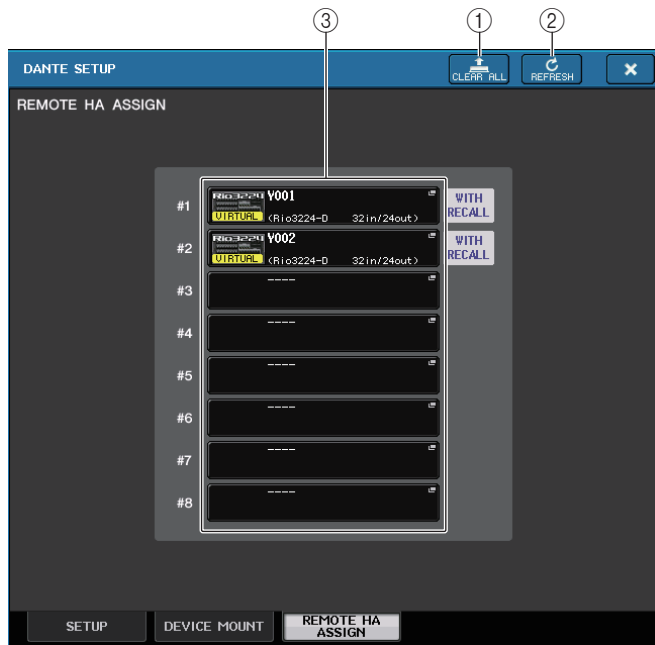

- 1 **CLEAR ALL button**  
Clears all HA devices in the list to an unmounted state.
- 2 **REFRESH button**  
Updates the displayed list of HA devices on the Dante audio network.

### 3 HA device select buttons

Press one of these buttons to open the REMOTE HA SELECT window. The upper line of the button shows the device label. The lower line of the button shows the model name and the number of inputs and outputs. If no device has been mounted, the upper row will indicate "----" and the lower row will show nothing.

For more information on VIRTUAL/CONFLICT/DUPLICATE shown below these buttons, refer to 1 on [page 127, "/I/O device list."](#)

## REMOTE HA SELECT window

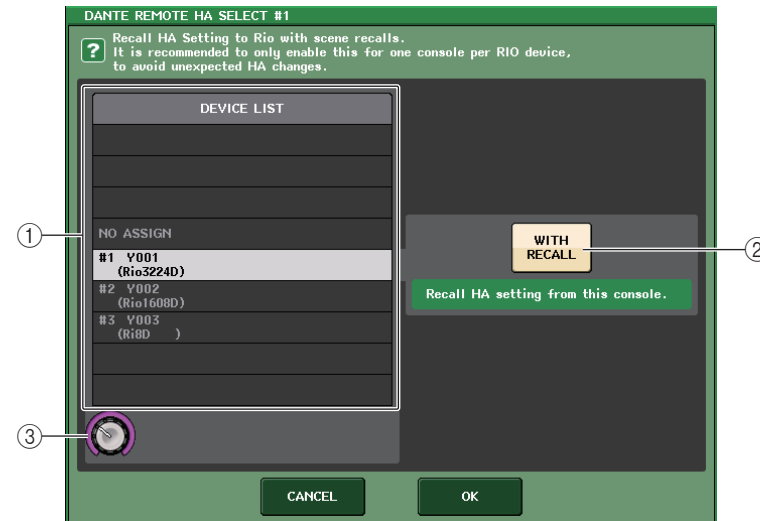

- 1 **DEVICE LIST**  
Shows a list of the HA devices on the Dante audio network.
- 2 **WITH RECALL button**  
If this button is on, the settings saved in the QL series console will be applied to the HA device when the QL series console starts up and when a scene is recalled.
- 3 **DEVICE LIST select knob**  
Use the [TOUCH AND TURN] knob to select the HA device that you want to mount.

### NOTE

- Do not specify "WITH RECALL" if an HA device is shared by multiple QL series consoles and settings have already been made on a different QL series console.
- The HA device can also be operated from a QL series console that is not set to "WITH RECALL."
- If an external QL series console has been mounted, you can set up and control the QL series console's INPUT HA in this window. However, make sure that the UNIT ID of the QL series console does not match the UNIT IDs of any other HA device.

## Displaying the device status

You can use the touch screen to verify the status of a connected QL series or R-series unit (except the Ro8-D) or the Dante status. In order to verify the status of an R-series unit from the console, it must be assigned to REMOTE HA in DANTE SETUP.

### ■ QL series

The SETUP field of the DANTE SETUP window shows indicators for the status of the QL series console and the Dante network.



### ■ R-series

The Rio field of the I/O DEVICE screen shows indicators for the status of the R-series units and the Dante network.

For firmware that predates support for V1.60, the version indication will be yellow and the indicator will be unlit.



## Messages

Error, warning, and information messages are displayed.

Messages are also displayed in the Dante Controller Error Status field.







Each indicator lights or flashes as described below:

No call-out	Unlit
Lit	The indicator remains lit steadily.
Blinking	The indicator continues to flash.
Flash x2	The indicator flashes twice cyclically.
Flash x3	The indicator flashes three times cyclically.

## ■ Error messages

The SYSTEM indicators will remain lit/blinking cyclically as follows until the problem has been resolved.



If service is necessary, please contact the Yamaha service center listed in the QL5/QL1 Owner's Manual.

[SYSTEM] indicators	Meaning	Possible solution
 <p>Flash x2</p>	An internal error has occurred.	The device has failed. Contact your Yamaha dealer for repair.
 <p>Flash x3</p>	The MAC address setting has been corrupted and no communication can occur via Dante.	
 <p>Lit Flash x3</p>	The internal memory has been corrupted.	If the problem persists after setting START UP MODE back to RESUME and turning the power on again, consult your Yamaha dealer.
 <p>Lit</p>	UNIT ID is not unique.	Set a unique UNIT ID number for the Dante network.
 <p>Blinking</p>	The DIP switches are not set correctly.	Check the DIP switch settings, and set them correctly.
 <p>Lit Blinking</p>	Dante flow number limit was exceeded.	Examine the Dante network routing.

## ■ Warning messages

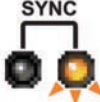

The indicators will remain lit/blinking cyclically until the problem has been resolved.

If the green [SYNC] indicator is not lit, the device's word clock is not defined.

[SYNC] indicators	Meaning	Possible solution
 <p>Blinking</p>	The word clock is not set correctly.	Set the word clock master and the sampling frequency correctly on the QL5/QL1-native device or in Dante Controller.
 <p>Flash x2</p>	Dante Network circuit is broken.	Make sure that the Ethernet cables are not removed or short-circuited.
 <p>Flash x3</p>	Dante Network is connected incorrectly. Other Dante devices cannot be found.	Make sure that the Ethernet cables are connected correctly.

If the green indicator is blinking, the unit is operating as the word clock master.

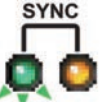
If the green indicator lights, the unit is operating as a word clock slave and syncing to the word clock.

[SYNC] indicators	Meaning	Possible solution
 <p>Lit or Lit blinking</p>	A non-GbE-compatible device is connected.	If audio is transmitted over the Dante network, use a GbE-compatible device.
 <p>Lit or Blinking blinking</p>	The SECONDARY connector has taken over communications during redundant network operation.	Check the circuit connected to the PRIMARY connector.

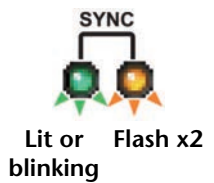

 <p>Lit or Flash x2 blinking</p>	<p>An abnormality has occurred on the circuit connected to the SECONDARY connector during redundant network operation.</p>	<p>Check the circuit connected to the SECONDARY connector.</p>
---	--	--

## Information messages

The indicators will remain lit/blinking cyclically to report the status.

If the orange [SYNC] indicator is not lit, the unit is operating correctly.

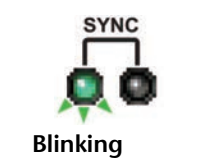
If the green [SYNC] indicator is not lit, the device's word clock is not defined.

[SYNC] indicators	Meaning	Possible solution
 <p>Lit</p>	<p>Synchronization is being performed.</p>	<p>Please wait until the unit synchronizes completely. It may take up to 45 seconds to synchronize completely.</p>
 <p>Blinking</p>	<p>The device is operating correctly as a word clock master.</p>	<p>This indicates that the device is operating as a word clock master.</p>
 <p>Lit</p>	<p>The device is operating correctly as a word clock slave.</p>	<p>This indicates that the device is operating as a word clock slave and syncing to the word clock.</p>

## Using GPI (General Purpose Interface)

The rear panel GPI (General Purpose Interface) connector can be used as an input/output connector. This connector provides five GPI IN ports and five GPI OUT ports. For example you can use an external switch to control internal parameters of the QL series console or to switch scenes. Conversely, operations or scene changes performed on the QL series console can send control signals to an external device.

For details on how to send control signals to an external device when you switch scenes, refer to [“Outputting a control signal to an external device in tandem with scene recall \(GPI OUT\)”](#) on [page 83](#).

## Using GPI IN

You can use the GPI IN ports of the GPI connector to control the parameters of the QL series console from an external device. For example, you could use an external switch to turn the QL series console's Talkback on/off, operate the Tap Tempo function, or switch scenes.

### STEP

1. Connect an external device to the QL series console's GPI connector.
2. In the Function Access Area, press the SETUP button.
3. In the SETUP screen, press the MIDI/GPI button.
4. In the MIDI/GPI screen, press the GPI tab.
5. Specify the switch attribute and POLARITY MODE for each port as appropriate for the specifications of the external device you're using.
6. To assign the function or parameter that you want to control, press the GPI IN SETUP button.
7. In each field of the GPI IN SETUP window, select the desired function and parameter, then press the OK button.

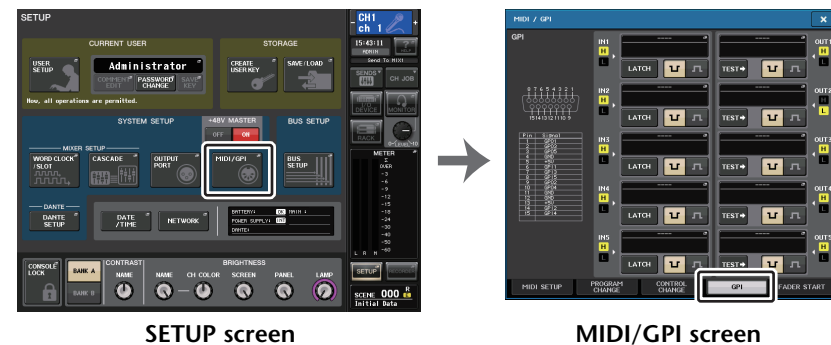

SETUP screen

MIDI/GPI screen

**NOTE**

- With latched operation, the function will switch between active and inactive each time a trigger is input from the external switch. In this case, we recommend that you use a non-locking type of external switch.
- With unlatched operation, the function will be active only while the signal from the external switch is at the high level or low level. In this case, you may use either a non-locking or a locking type of external switch as appropriate for your needs.
- Settings in the GPI page of the MIDI/GPI screen are common to all scenes. They can be saved as SETUP data.

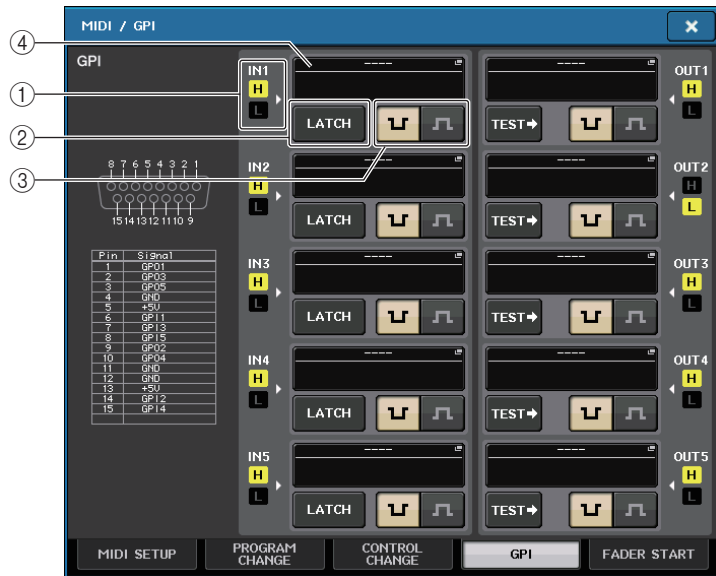
**MIDI/GPI screen (GPI page)****① GPI IN status indicator**

This indicates the status of the voltage being input to the GPI IN port.

**② Switch attribute select button**

This button selects the switch attribute. Each time you press the button, its indication will alternate between LATCH and UNLATCH.

**LATCH** ..... LATCH (a switch that alternately turns on/off each time it is pressed) is selected.

**UNLATCH** ..... UNLATCH (a switch that is on only while pressed and is off when released) is selected.

**③ POLARITY MODE select button**

This button selects the polarity of the GPI IN port.

**Low active** ..... (Low active) When operating an on/off-type parameter, it will become active when the switch is grounded.

**High active** ..... (High active) When operating an on/off-type parameter, it will become active when the switch is opened or when a high-level voltage is input.

**④ GPI IN SETUP button**

The button shows the name of the currently-selected function or parameter. Press this button to display the GPI IN SETUP window.

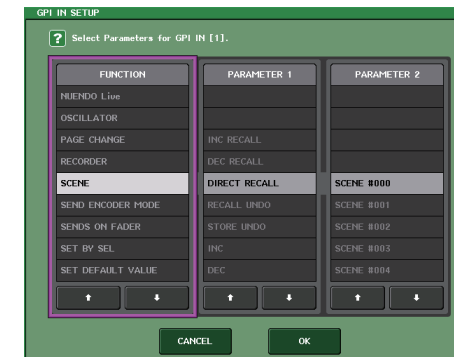
**NOTE**

The items that can be selected in the GPI IN SETUP window are the same as for the USER DEFINED keys (page 169).

**Using GPI OUT**

The GPI OUT ports of the GPI OUT connector allow you to control an external device by performing operations on the QL series console.

**STEP**

1. Connect an external device to the QL series console's GPI connector.
2. In the Function Access Area, press the SETUP button.
3. In the SETUP screen, press the MIDI/GPI button.
4. In the MIDI/GPI screen, press the GPI tab.
5. Specify the POLARITY MODE for each port as appropriate for the specifications of the external device you're using.
6. To assign a function or parameter that you want to control, press the GPI OUT SETUP button.
7. In each field of the GPI OUT SETUP window, select the desired function and parameter, then press the OK button.





SETUP screen

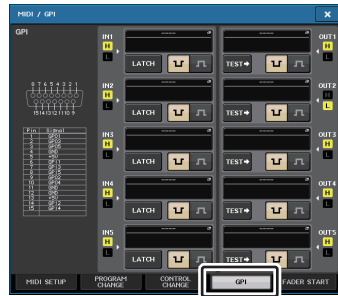

MIDI/GPI screen

MIDI/GPI screen (GPI page)

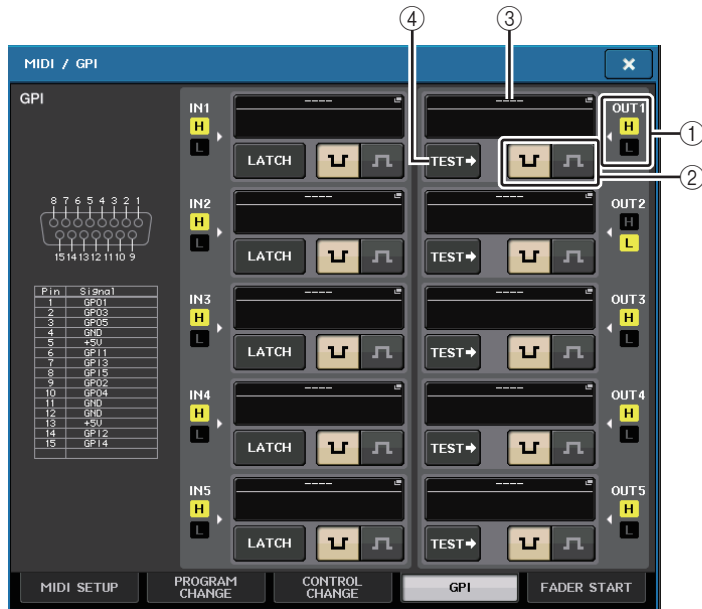

① GPI OUT status indicator

This indicates the status of the voltage that is being output from each GPI OUT port.

② POLARITY MODE select button

This button selects the polarity of the GPI OUT port.

 ..... (Low active) Grounded when the GPI OUT port is active.

 ..... (High active) Open when the GPI OUT port is active.

③ GPI OUT SETUP button

The button shows the name of the currently-selected function or parameter. Press this button to display the GPI OUT SETUP window.

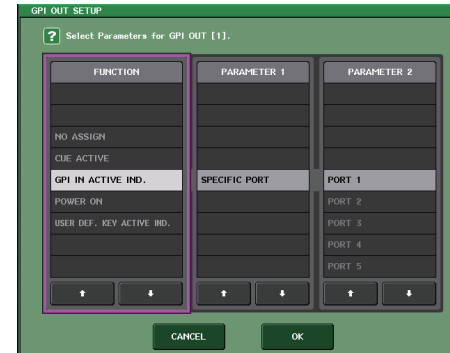

You can assign the following functions.

Function	Parameter	QL console operation
NO ASSIGN	---	No assignment
CUE ACTIVE	CUE ON	Turn on the [CUE] key of the selected channel
	DCA ONLY	Turn on the DCA [CUE] key
	INPUT ONLY	Turn on the [CUE] key of an input channel
	OUTPUT ONLY	Turn on the [CUE] key of an output channel
GPI IN ACTIVE IND.	PORT 1–PORT 5	The function assigned to GPI IN port 1–5 becomes active
POWER ON	---	The power of the QL series console is turned on
USER DEF. KEY ACTIVE IND.	USER DEFINED KEY 1–USER DEFINED KEY 16	The function assigned to the USER DEFINED key becomes active

④ TEST button

While this is on, the corresponding GPI OUT port will be active and will output a control signal.

## Using FADER START

Make FADER START settings if you want a device connected to a GPI OUT port to operate in tandem with fader operations.

### STEP

1. Connect an external device to the QL series console's GPI connector.
2. In the Function Access Area, press the SETUP button.
3. In the SETUP screen, press the MIDI/GPI button.
4. In the MIDI/GPI screen, press the FADER START tab.
5. For each GPI OUT port, specify the channel that will cause the external device to operate, and the type of operation.

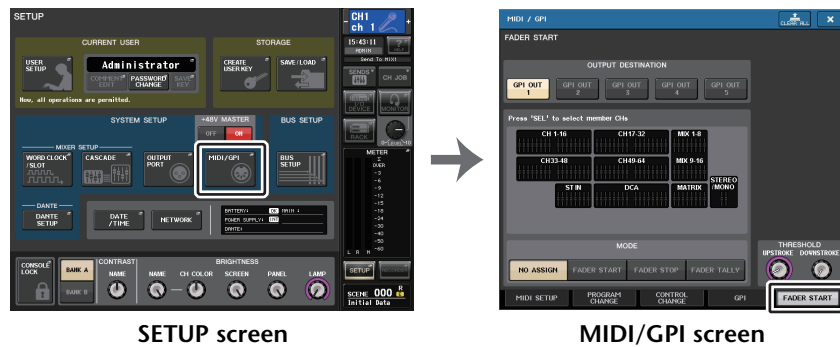

SETUP screen

MIDI/GPI screen

## MIDI/GPI screen (FADER START page)

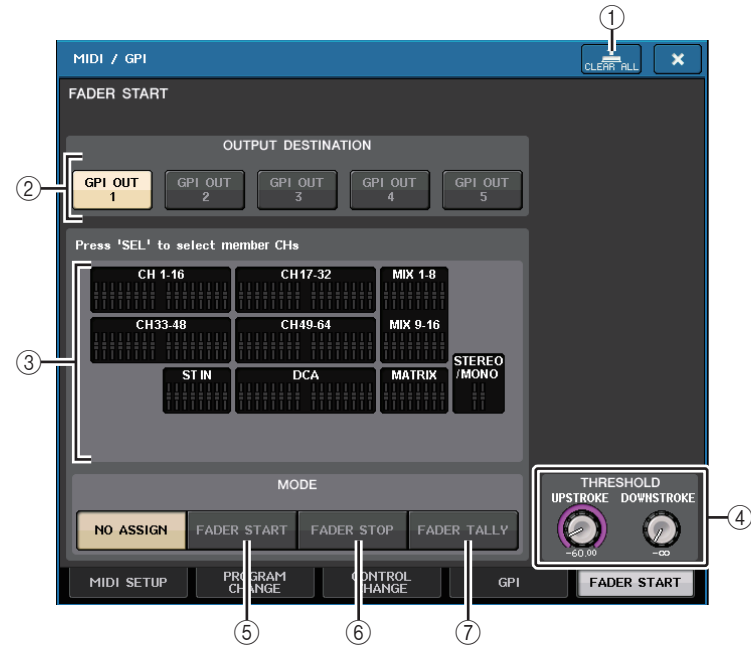

- 1 **CLEAR ALL button**  
Clears all selections.
- 2 **OUTPUT DESTINATION field**
  - **GPI OUT1–GPI OUT5 buttons**  
Select the GPI OUT port for which you want to make settings.
- 3 **Fader indicator**  
This indicates the selected fader. Use the [SEL] keys on the panel to select a fader.

### NOTE

In the case of QL1, channels that do not exist on the model will not be shown.

#### ④ THRESHOLD field

##### • UPSTROKE/DOWNSTROKE knobs

These specify the level that will be the threshold for outputting a trigger signal. A trigger signal will be output when the fader exceeds the UPSTROKE level, or when the fader falls below the DOWNSTROKE level. You can use the [TOUCH AND TURN] knob to operate these parameters.

##### NOTE

- The THRESHOLD values specified by the UPSTROKE/DOWNSTROKE knobs are common to all GPI OUT ports. However, you can individually choose the channel (fader) for each GPI OUT port.
- Only the UPSTROKE value will be valid if MODE is set to FADER START, and only the DOWNSTROKE value will be valid if MODE is set to FADER STOP. If MODE is set to FADER TALLY, both the UPSTROKE and DOWNSTROKE values will be valid.

#### ⑤ MODE field

Here you can select the mode of fader operation that will be the trigger for signal output from the GPI OUT port. You can choose from the following fader modes.

##### • NO ASSIGN

Operating the fader of the selected channel will not cause a signal to be output.

##### • FADER START



A trigger signal 250 msec long will be output when the fader of the selected channel moves upward through the specified UPSTROKE level (–138.0 dB to 10.0 dB) from a point below it.

##### • FADER STOP

A trigger signal 250 msec long will be output when the fader of the selected channel reaches the specified DOWNSTROKE level (–∞ dB to 9.95 dB).

##### • FADER TALLY

A trigger signal will be output when the fader of the selected channel moves upward through the specified UPSTROKE level (–138.0 dB to 10.0 dB) from a point below it. This signal will be held until the fader reaches the specified DOWNSTROKE level (–∞ dB to 9.95 dB) or until that GPI OUT port receives a different trigger.

The following illustration shows how the signal that is output from the GPI PORT will change in each fader mode when a fader is operated. In this example, UPSTROKE in the THRESHOLD field is set to –60.00, and DOWNSTROKE is set to –∞. (This illustration shows the case in which  is selected as the polarity of the GPI OUT port. If the polarity is , the polarity of the output signal will be reversed.)

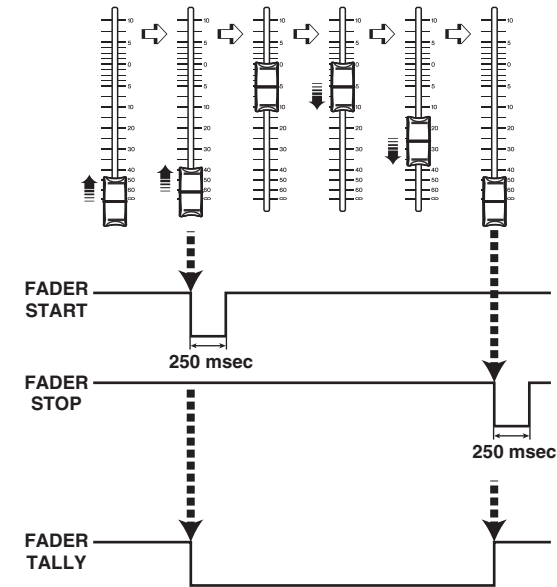

##### NOTE

At the high level, the output signal of the port will be open. If the receiving device requires high level, take it from the +5V power supply pin. However in this case, the amount of current is limited; for details, refer to “Control I/O specifications” on the QL Data List (End of Manual).

## Help function

You can view Help files (file extension .xml) provided by Yamaha. For the latest information on help files, refer to the Yamaha Pro Audio website.

<http://www.yamahaproaudio.com/>

In addition, using a commercially available text editor or the “Notepad” included with Microsoft Windows, you can create a text file (file extension .txt) and display it on the console\*.

\* We accept no responsibility for any damage that may occur as a result of using Help files created by a third party other than Yamaha.

## Loading a Help/text file from a USB flash drive

### NOTE

A help file for only one language is stored in the console's internal memory. Once you load the help file, it will be preserved in internal memory even if the power is turned off. The first time you press the HELP button to view the help file after turning the power on, it will take a while for the help file to be loaded from internal memory. Once the data has finished loading, subsequently pressing the HELP button will display the help file instantly.

### STEP

1. Save the Help file provided by Yamaha or a user-created text file on your USB flash drive.
2. In the Function Access Area, press the SETUP button.
3. In the SETUP screen, press the SAVE/LOAD button.
4. To select the Help/text file that you want to load, press one of the Help/text files in the file list in the SAVE/LOAD window, or turn the [TOUCH AND TURN] knob.
5. Press the LOAD button.
6. Press the OK button in the confirmation dialog box to load the file.



SAVE/LOAD window

### NOTE



By default, the character code set of the text file will be detected as UTF-8. However, by adding a line consisting of [ISO-8859-1] or [Shift\_JIS] at the beginning of the file, you can force recognition of the file using that character code set. You can specify the desired character code set when using your text editor to save the text file.

The Help function is able to display the following text files (character code sets /languages).

- Text files written in the ISO-8859-1 character code set (English, German, French, Spanish, etc.)
- Text files written in the Shift\_JIS character code set (Japanese)
- Text files of the above languages written in the UTF-8 character code set
- The maximum size of the text file is 1024 Kbytes.



## Viewing Help

### STEP

1. Load the Help file or text file from your USB flash drive.
2. In the Function Access Area, press the  (Help) button.
3. To close the HELP window, press the  (Help) button of the Function Access Area or the “x” symbol of the HELP window.

### ■ Operation in the HELP window

You can use the [TOUCH AND TURN] knob or screen buttons to access the HELP window.

- **Turning the [TOUCH AND TURN] knob**  
..... To scroll through the index area, use the left knob; to scroll through main area, use the right knob.
- **Pressing a link (underlined text) in the text**  
..... Scrolls to the linked destination.
- **Pressing a window link (a location with an → symbol and underlined text)**  
..... Closes the HELP window and opens the corresponding window.
- **Pressing the  button**  
..... Scrolls to the chapter that precedes the currently-displayed location.
- **Pressing the  button**  
..... Returns to the preceding item in the history of links you pressed.
- **Pressing the  button**  
..... Advances to the next item in the history of links you pressed.

## Using USER DEFINED keys to recall Help directly

### Assigning the Help function to USER DEFINED keys

#### STEP

1. Load the Help file from your USB flash drive.
2. In the Function Access Area, press the SETUP button.
3. Press the USER SETUP button in the upper left of the SETUP screen.
4. In the USER SETUP window, press the USER DEFINED KEYS tab.
5. In the USER DEFINED KEYS page, press the button corresponding to the USER DEFINED key to which you want to assign the Help function.
6. In the FUNCTION column, choose "HELP" and press the OK button.
7. Press the "x" symbol to close the USER DEFINED KEYS page.
8. In the Function Access Area, press the SETUP button to close the SETUP screen.

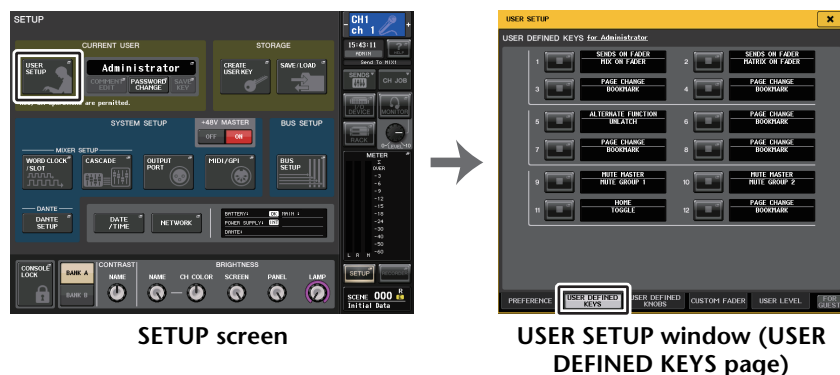

SETUP screen

USER SETUP window (USER DEFINED KEYS page)

### Recalling the HELP window using only a USER DEFINED key

Press the USER DEFINED key to which the Help function is assigned. The HELP window will appear. To close the window, once again press the USER DEFINED key to which the Help function is assigned.

### Directly recalling the Help for a specific panel controller

While holding down the USER DEFINED key to which you have assigned the Help function, press (or rotate) the panel controller for which you want to recall Help. If the explanation is available for the controller, the help for the corresponding item will appear.

To close the window, once again press the USER DEFINED key to which the Help function is assigned.

#### NOTE

- Panel controllers (other than the faders and the MONITOR LEVEL knob) will not function as long as you continue holding down the USER DEFINED key to which the Help function is assigned.
- If there are multiple explanations for the same controller, you can repeat the steps above to successively display these explanations.

### Directly recalling the Help for a specific controller in the LCD screen

While holding down the USER DEFINED key to which you have assigned the Help function, press the on-screen controller for which you want to recall Help. If the explanation is available for the controller, the help for the corresponding item will appear.

To close the window, once again press the USER DEFINED key to which the Help function is assigned.

#### NOTE

- The on-screen controllers will not function as long as you continue holding down the USER DEFINED key to which the Help function is assigned.
- If there are multiple explanations for the same controller, you can repeat the steps above to successively display these explanations.

## Other functions

This chapter explains various functions of QL series consoles that are not covered in other chapters.

### Initializing the unit to factory default settings

If an error occurs in the QL console internal memory, or if you forget the password and cannot operate the unit, you can use the following procedure to initialize the internal memory.

There are two types of initialization of the internal memory as shown below.

#### INITIALIZE ALL MEMORIES

The entire memory, including scene memories and libraries, will be returned to factory default settings.

#### INITIALIZE CURRENT MEMORIES

The contents of memory - except for scene memories and libraries - will be returned to its factory default settings.

#### NOTICE

The entire memory will be deleted if you initialize the internal memory! Proceed with the operation only if you are very sure you want to delete the entire memory.

#### STEP

1. While holding down the [SEL] key for Fader B in the MASTER section on the panel, turn on the power to the QL unit.
2. On the startup menu screen, select the initialization method.
3. Press the INITIALIZE button in the dialog box to confirm initialization.
4. Press the OK button in the confirmation dialog box to start initialization.
5. A message indicates that the initialization process is complete. Press the EXIT button on the startup menu screen.

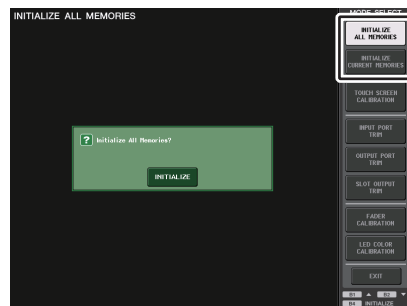

Startup menu screen

#### NOTE

- Do not press any buttons until initialization is complete.
- Once initialization is complete, you can continue operation by selecting a different menu instead of pressing the EXIT button.

### Adjusting the detection point of the touch screen (Calibration function)

Follow the steps below to correctly align the positions of the LCD display and the touch screen.

#### STEP

1. While holding down the [SEL] key for Fader B in the MASTER section on the panel, turn on the power to the QL unit.
2. On the startup menu screen, press the TOUCH SCREEN CALIBRATION button.
3. Press the START button in the TOUCH SCREEN CALIBRATION MODE screen.
4. Press the OK button in the confirmation dialog box to start calibration.
5. A cross-shaped cursor will appear in the screen (a total of three times). Press each location at which it appears.
6. Press the EXIT button on the startup menu screen to start up the QL unit in normal operating mode.

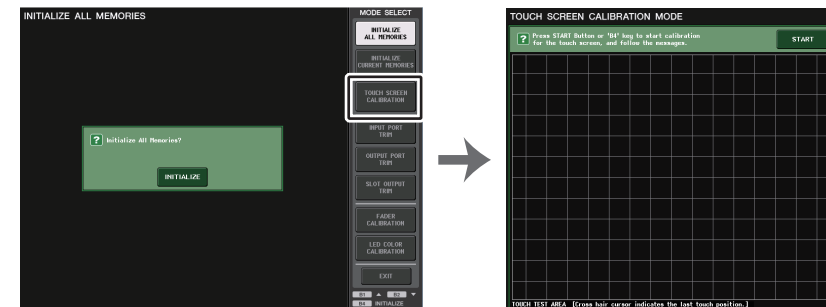

Startup menu screen

TOUCH SCREEN CALIBRATION  
MODE screen

#### NOTE

- If you are unable to start calibration by pressing the TOUCH SCREEN CALIBRATION button, you can use the [B1]/[B2] keys in the Fader Bank section to select TOUCH SCREEN CALIBRATION, and then press the [B4] key to start.
- To set the detection points accurately, press the cross-shaped cursor from the position and posture in which you normally operate the unit.
- Once initialization is complete, you can continue operation by selecting a different menu instead of pressing the EXIT button.

## Adjusting the faders (Calibration function)

Depending on the environment in which you use the QL series console, discrepancies may occur in the motion of the motor faders. You can use the Calibration function to correct these discrepancies.

### NOTE

With this operation, the specified faders in the Channel Strip section and Master section will be semi-automatically calibrated. This window will also appear if a problem is detected in the fader settings while the QL is starting up.

### STEP

1. While holding down the [SEL] key for Fader B in the MASTER section on the panel, turn on the power to the QL unit.
2. On the startup menu screen, press the FADER CALIBRATION button.
3. Press a [SEL] key to select the faders that you want to calibrate.
4. Press the START button in the FADER CALIBRATION MODE screen.
5. Press the OK button in the confirmation dialog box.
6. Each of the specified faders will move to  $-\infty$  dB (all the way down). If the fader positions are not correct, move them manually to  $-\infty$  dB (all the way down).
7. After you adjust the fader position, press the NEXT button.
8. Repeat steps 6–7 to adjust three fader positions at 20 dB, 0 dB, +10 dB (all the way up).  
When adjustment to the +10 dB position is complete, calibration starts.
9. When calibration has been completed, press the APPLY button.
10. Press the EXIT button on the startup menu screen to start up the QL unit in normal operating mode.

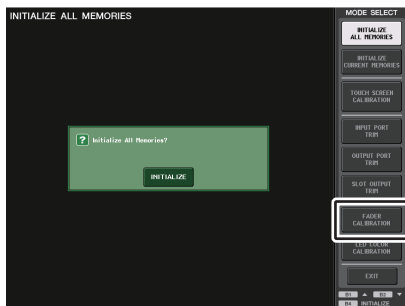

Startup menu screen

### NOTE

- Faders for which a problem was detected at start-up will already be selected in step 3.
- If the RESTART button appears, calibration has failed. Press the RESTART button to execute calibration once again.
- Once initialization is complete, you can continue operation by selecting a different menu instead of pressing the EXIT button.

## Fine-tuning the input and output gain (Calibration function)

If necessary, you can make fine adjustments to the input and output gain.

### STEP

1. While holding down the [SEL] key for Fader B in the MASTER section on the panel, turn on the power to the QL unit.
2. In the MODE SELECT field on the startup menu screen, press the button for the item you want to adjust.
3. Press an on-screen knob to select it, and then use the [TOUCH AND TURN] knob to adjust the value.
4. Press the EXIT button on the startup menu screen to start up the QL unit in normal operating mode.

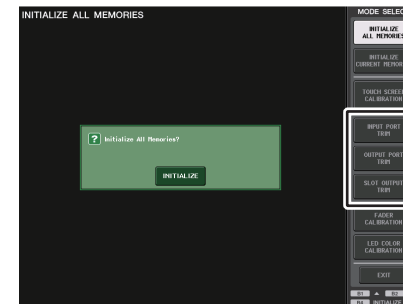

Startup menu screen

### NOTE

- If you press the RESET ALL button provided in each screen, all settings in the screen will be reset to 0 dB.  
The factory settings are also 0 dB.
- Once initialization is complete, you can continue operation by selecting a different menu instead of pressing the EXIT button.



- INPUT PORT TRIM (Fine adjustment of the analog input gain)**  
 Access the INPUT PORT TRIM window, and make fine adjustments to the gain of the specified analog input port in 0.1 dB steps.



- SLOT OUTPUT TRIM (Fine adjustment of the slot output port gain)**  
 Access the SLOT OUTPUT TRIM window, and make fine adjustments to the gain of the output ports of the specified slot in 0.01 dB steps.



- OUTPUT PORT TRIM (Fine adjustment of the output port gain)**  
 Access the OUTPUT PORT TRIM window, and make fine adjustments to the gain of the specified analog output port in 0.01 dB steps.

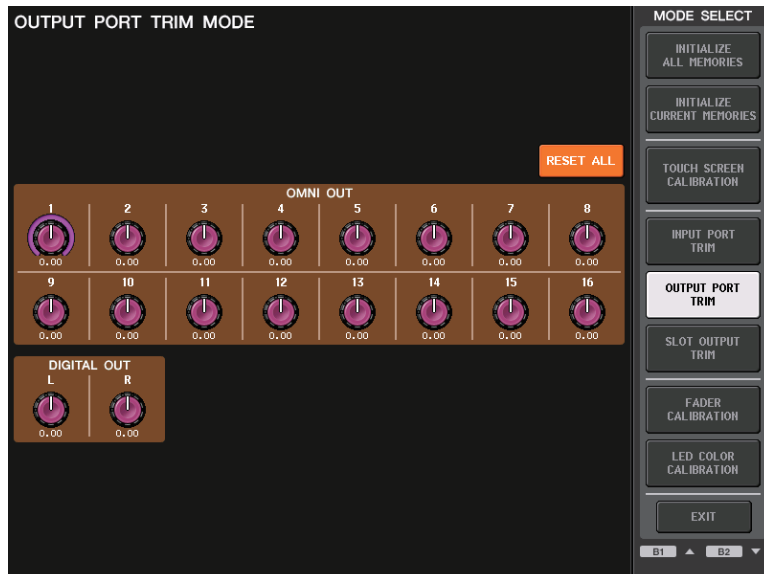

## Adjusting the LED color (Calibration function)

If necessary, you can adjust the LED colors. Adjust the LED colors one by one.

### STEP

1. While holding down the [SEL] key for Fader B in the MASTER section on the panel, turn on the power to the QL unit.
2. On the startup menu screen, press the LED COLOR CALIBRATION button.
3. Press a [SEL] key on the top panel to select the indicator for which you want to adjust the channel color.  
If you want to adjust the indicator color of the [TOUCH AND TURN] knob, press the TOUCH AND TURN button in the LED field.
4. Press one of the color buttons in the COLOR field to select the desired color.
5. While comparing the color of the selected channel's indicator with the color of the other channel indicators (for which the [SEL] keys are turned off), adjust the color by using the [TOUCH AND TURN] knob to operate the RGB knobs in the RPG ADJUSTMENT field.
6. When you have finished adjusting the color, press the APPLY button located in the right of the screen to confirm the change.
7. Press the EXIT button on the startup menu screen to start up the QL unit in normal operating mode.



LED COLOR CALIBRATION MODE  
screen



LED field

### NOTE

- In the case of QL1, channels that do not exist on the model will not be shown.
- You cannot adjust more than one channel simultaneously.
- The APPLY button appears only if you change the RGB values.
- To reset all LED color indicators to the factory default setting, press the RESET ALL button.
- Once initialization is complete, you can continue operation by selecting a different menu instead of pressing the EXIT button.



## Adjusting the brightness of the channel name display

If necessary, you can adjust the brightness of the channel name display.

### STEP

1. While holding down the [SEL] key for Fader B in the MASTER section on the panel, turn on the power to the QL unit.
2. On the startup menu screen, press the LED COLOR CALIBRATION button.
3. Press the [CUE] key or [ON] key of the channel whose brightness you want to adjust. Pressing the [CUE] key will increase the brightness, and pressing the [ON] key will decrease the brightness.
4. When you have finished adjusting the brightness, press the APPLY button located in the right of the screen to confirm the change.
5. Press the EXIT button on the startup menu screen to start up the QL unit in normal operating mode.

### NOTE

Alternatively, you can continue operation by selecting a different menu instead of pressing the EXIT button.

## Adjusting the contrast of the channel name display

If necessary, you can adjust the contrast of the channel name display.

---

### STEP

1. While holding down the [SEL] key for Fader B in the MASTER section on the panel, turn on the power to the QL unit.
2. On the startup menu screen, press the LED COLOR CALIBRATION button.
3. Turn the [GAIN] knob in the Selected Channel section.  
Turning the knob toward the left will lighten the contrast of all channels; turning it toward the right will darken the contrast of all channels.
4. If you want to adjust a channel whose contrast differs from that of the other channels, hold down the [SEL] key of the desired channel and press its [CUE] key or [ON] key.  
Pressing the [CUE] key will darken the contrast, and pressing the [ON] key will lighten the contrast.
5. When you have finished adjusting the contrast, press the APPLY button located in the right of the screen to confirm the change.
6. Press the EXIT button on the startup menu screen to start up the QL unit in normal operating mode.

---

### NOTE

- The APPLY button appears only if you change the setting.
- Alternatively, you can continue operation by selecting a different menu instead of pressing the EXIT button.

## Initializing the Dante audio network settings

It is possible for Dante-related settings to be initialized to their factory-set state when an error occurs on the Dante audio network.

### NOTICE

When you initialize, all console settings including the Dante audio network settings that had been previously saved in memory will be lost.

---

### STEP

1. While holding down both [SEL] keys for Faders A and B in the MASTER section on the panel, turn on the power to the QL unit.
  2. A message indicates that initialization process is complete. Press the CLOSE button.
-

# Warning/Error Messages

Message	Meaning
xxx Parameters Copied.	Parameter xxx was copied to the copy buffer.
xxx Parameters Initialized.	Parameter xxx was initialized.
xxx Parameters Pasted.	Parameter xxx was pasted from the copy buffer.
xxx Parameters Swapped with Copy Buffer.	Parameter xxx was exchanged with the contents of the copy buffer.
ALTERNATE FUNCTION: Turned off!	ALTERNATE FUNCTION was turned off.
Cannot Assign!	In the USER DEFINED KEYS popup of the QL1, you attempted to edit an item that cannot be edited for that model.
Cannot Bookmark This Popup.	This popup window cannot be bookmarked.
Cannot Mount This Type of Device in This Position.	You attempted to mount a specific device at a position where it cannot be mounted.
Cannot Paste to Different Parameter Type!	Parameters of one type cannot be pasted to another different type.
Cannot Paste!	Cannot paste the character string.
Cannot Recall!	Failed to recall a scene memory or library.
Cannot Select This Channel.	You attempted to select a channel that cannot be operated due to your user level or some other reason.
Cannot Store!	Failed to store a scene memory or library.
Cannot Undo!	You pressed the UNDO button when Undo was not available.
Channel Copied.	Channel settings have been copied.
Channel Moved.	Channel settings have been moved.
Channel Returned to Default Settings.	Channel settings have been returned to the default settings.
Console initialized due to memory mismatch.	All data has been initialized because the data in internal backup memory has been lost, due to an update or failure of the backup battery or some other reason. Please contact your Yamaha service center listed at the end of the Owner's Manual (separate document).
Corrupted data fixed!	Data has been repaired.
Couldn't Access File.	File on the USB flash drive could not be accessed for some reason.
Couldn't Write File.	File could not be saved to the USB flash drive.
Current User Changed. [xxx]	Current user was changed to [xxx].
DANTE audio resource overflow.	Audio resources are not enough for the Dante audio network.
DANTE Connection Error!	You have the wrong connection of PRIMARY and SECONDARY in the daisy chain network.
DANTE is not working by GIGA bit.	The Dante audio network is not functioning as Giga-bit Ethernet.
DANTE is working at Secondary.	The Dante audio network is operating in the SECONDARY PORT.
DANTE module Error!	The Dante module has malfunctioned.
Different File Format! Some Data was not Loaded.	Data was loaded in a format that is not supported.

Message	Meaning
Directory Not Empty!	You attempted to delete a directory, but failed because there were files remaining in the directory.
Editor: Data Framing Error! Editor: Data Overrun!	Invalid signals are being exchanged with QL Editor.
Editor: Rx Buffer Full!	Too much data is being received at the QL Editor input port.
Editor: Tx Buffer Full!	Too much data is being transmitted from the QL Editor output port.
EFFECT CUE: Turned Off.	CUE was defeated because you switched from the EFFECT popup window or the premium rack popup window to a different screen.
Error occurred at Secondary Port.	The Ethernet cable of the SECONDARY connector has been removed during the REDUNDANT setting.
External HA Connection Conflict!	External HA data could not be recalled, because the state of connections to the external HA has changed since the scene was stored.
File Access is Busy!	The following operation has not been performed yet because the USB flash drive is being accessed.
File Already Exists!	The USB flash drive already contains a file/directory with the same name as the one you are attempting to save, rename, or create.
File Error [xx]!	Internal file access error
File Protected!	Overwriting was not possible because the file on the USB flash drive is write-protected.
Flash Memory Initializing Finished.	Memory initialization has been completed.
Help File Not Found!	The help file has not been loaded.
Illegal Address!	The IP address or Gateway address setting is invalid.
Illegal DIP Switch Setting.	The DIP switches of the R series are not set correctly.
Illegal MAC Address! Cannot Use Ethernet.	Communication via the Network connector is not possible because the MAC address setting has been damaged for some reason. Please contact your Yamaha service center listed at the end of the Owner's Manual (separate document).
Illegal MAC Address!	The QL series started up with an illegal MAC Address.
Illegal Storage Format!	The USB flash drive could not be accessed because its format is invalid or unsupported.
KEY IN CUE: Turned Off.	KEY IN CUE was defeated because you switched from the DYNAMICS 1 popup window of an input channel to a different screen.
Loading Aborted.	Loading from USB flash drive was aborted.
Loading Finished.	Finished loading from USB flash drive.
Low Battery!	The backup battery voltage is low.
Maximum Number of Audio Files Exceeded!	The number of songs that can be managed by the USB memory recorder has been exceeded.
Memory Error.	The backup memory of the R series has been corrupted.
MIDI: Data Framing Error! MIDI: Data Overrun!	An inappropriate signal is being input to the MIDI input port.
MIDI: Rx Buffer Full!	Too much data is being received at the MIDI input port.
MIDI: Tx Buffer Full!	Too much data is being transmitted from the MIDI output port.

Message	Meaning
<b>Monitor Assignment is Restricted to Max. 8 Sources!</b>	The Monitor Define function allows a maximum of eight sources to be selected, but you attempted to assign more than eight.
<b>No Access From Recorder!</b>	In the RECORDER screen, it is not possible to move to a level higher than \YPE\SONGS\.
<b>No Channel Selected.</b>	A copy-source channel was not selected in the GLOBAL PASTE screen.
<b>No Copy Item Selected.</b>	In the GLOBAL PASTE screen, you attempted to paste without having selected an item to paste.
<b>No Corresponding Help Items.</b>	The corresponding section was not found in the Help file.
<b>No ID3 Tag exists. You can not edit.</b>	The music file cannot be edited because it has no ID3 tag.
<b>No Response from External HA.</b>	No response from an external AD8HR.
<b>No Response from I/O DEVICE.</b>	The I/O devices not responding.
<b>Operating as the word clock master.</b>	The QL series is operating correctly as a word clock master.
<b>Page Bookmarked.</b>	The current screen or popup has been bookmarked.
<b>Parameter out of range!</b>	Some data could not be loaded because of a parameter mismatch.
<b>Password Changed.</b>	The password has been changed.
<b>PlayBack Failed: Recorder is Busy!</b>	Audio file link playback is not possible because recording is in progress.
<b>PLAYBACK OUT CUE: Turned Off.</b>	CUE was canceled for PLAYBACK OUT because you switched from the RECORDER screen to another screen.
<b>Please use Dante Controller.</b>	DANTE PATCH settings from the console are not enabled.
<b>Please wait, Dante patch is proceeding now.</b>	You attempted to edit in the DANTE PATCH screen at a time when patching was not possible.
<b>Power Supply Fan has Malfunctioned!</b>	The cooling fan of the internal power supply has stopped. Please contact your Yamaha service center listed at the end of the Owner's Manual (separate document).
<b>PREVIEW Mode : Cannot Use This Function.</b>	The operation was ignored because this function cannot be used during Preview.
<b>PREVIEW Mode : Disabled</b>	Preview was disabled.
<b>PREVIEW Mode : Enabled</b>	Preview was enabled.
<b>Processing Aborted.</b>	Processing was interrupted.
<b>Recorder Busy: Operation Aborted!</b>	Operation of the button was canceled because time is required for recorder processing.
<b>RECORDER: CODEC Error [0x%08X] !</b>	A codec error occurred in the RECORDER screen.
<b>RECORDER IN CUE: Turned Off.</b>	CUE was canceled for RECORDER IN because you switched from the RECORDER screen to another screen.
<b>Re-Enter Password!</b>	When specifying the user password, the password was not entered a second time.
<b>REMOTE: Data Framing Error! REMOTE: Data Overrun!</b>	An inappropriate signal has been input to the Remote connector.
<b>REMOTE: Rx Buffer Full!</b>	Too much data has been received at the Remote connector.
<b>REMOTE: Tx Buffer Full!</b>	Too much data has been transmitted from the Remote connector.
<b>Removed from the Channel Link group.</b>	The channel was removed from the link group.

Message	Meaning
<b>Saving Aborted.</b>	Saving to the USB flash drive has been interrupted.
<b>Saving Finished.</b>	Finished saving to USB flash drive.
<b>SCENE #xxx is Empty!</b>	No data has been stored in the scene you attempted to recall, or the data has been damaged so that it cannot be recalled.
<b>SCENE #xxx is Protected!</b>	You attempted to overwrite (store) a protected scene.
<b>SCENE #xxx is Read Only!</b>	You attempted to overwrite (store) a read-only scene.
<b>Scene Playback Link Canceled!</b>	The audio playback link for the scene was canceled.
<b>SLOT x: Data Framing Error! SLOT x: Data Overrun!</b>	Invalid signals are being input to the SLOT x input port.
<b>SLOT x: Rx Buffer Full!</b>	Too much data is being received at the SLOT x input port.
<b>SLOT x: Tx Buffer Full!</b>	Too much data is being transmitted from the SLOT x output port.
<b>Some Song Files Are Unidentified.</b>	Some songs were not identified. Songs that have not been specified might be used for DIRECT PLAY or SCENE PLAY BACK LINK.
<b>Song File Not Found!</b>	The file specified for SCENE LINK or DIRECT PLAY assigned to a USER DEFINED key does not exist.
<b>STAGEMIX: Data Framing Error! STAGEMIX: Data Overrun!</b>	Invalid signals are being exchanged with StageMix.
<b>STAGEMIX: Rx Buffer Full!</b>	Too much data is being received at the StageMix input port.
<b>STAGEMIX: Tx Buffer Full!</b>	Too much data is being transmitted from the StageMix output port.
<b>Storage Full!</b>	The file could not be saved because there is insufficient space on the USB flash drive.
<b>Storage Not Found!</b>	The USB flash drive could not be recognized.
<b>Storage Not Ready!</b>	Access is not possible because the USB flash drive is not ready.
<b>Sync Error! [xxx]</b>	The QL series console is not synchronized to the [xxx] signal.
<b>Tap Operation Ignored.</b>	Tap operation was ignored because the TAP TEMPO button is not displayed in the screen.
<b>This Operation is Not Allowed.</b>	This operation has been ignored because the current user does not have permission.
<b>This page does not exist in this model.</b>	You attempted to open a bookmark or window that does not exist in the QL series.
<b>Too Large Files! Loading Failed.</b>	Loading is not possible because the bitmap file is too large. The maximum supported file size is 307,256 Bytes. Or loading is not possible because the bitmap file is too large. The maximum supported file size is 1024 kilobytes.
<b>Too Many Bands Used! Cannot Compare.</b>	Copying 31BandGEQ and comparing it to Flex15GEQ has failed because more than 15 bands are included in the copy source.
<b>Too Many Bands Used! Cannot Paste to Flex15GEQ.</b>	Copying and pasting 31BandGEQ to Flex15GEQ has failed because more than 15 bands are included in the copy source.
<b>Total Slot Power Capability Exceeded!</b>	Power consumption of the I/O cards installed in the slots has exceeded the rated value.
<b>Unassigned Encoder.</b>	Your operation has been ignored because there is no parameter that corresponds to the knob you operated.
<b>Unit Fan has Malfunctioned</b>	The fan of the R series has malfunctioned.

Message	Meaning
<b>Unit ID Duplicated!</b>	The currently entered UNIT ID is not unique on the Dante audio network.
<b>Unsupported File Format!</b>	The file you attempted to load from the USB flash drive is of an unsupported format.
<b>USB Currently Active for Recorder function!</b>	Save or Load operations are unavailable because the USB memory recorder is recording or playing.
<b>USB Currently Active for SAVE or LOAD!</b>	The recorder cannot operate, since mixer scene memory or library data is being saved to or loaded from the USB flash drive.
<b>USB Memory Busy: Recorder Stopped!</b>	Recording/playback stopped because time is required for USB flash drive processing.
<b>USB Memory Full !</b>	Can't save the RECORDER playlist because there is insufficient free space on the USB flash drive.
<b>USB Memory Full! Recorder Stopped.</b>	Recorder processing was halted because the USB flash drive capacity ran out while the USB memory recorder was operating.
<b>USB Memory is Protected!</b>	The USB flash drive's Protect setting is turned on.
<b>USB Memory Unmounted! Recorder Stopped.</b>	Recorder processing was halted because the USB flash drive was disconnected while the USB memory recorder was operating.
<b>USB over current Error! Disconnect USB device.</b>	The USB device was disconnected because of excessive USB current.
<b>Version Changed. All Memories were Initialized.</b>	The contents of the current memory are initialized by the upgrade.
<b>Version mismatch.</b>	The current version of the R series is not compatible with the version of the CL series and the QL series.
<b>Word Clock Error! Recorder Stopped!</b>	Recorder was halted because synchronization to the word clock was lost.
<b>Wrong Audio File Format!</b>	The format of the audio file is invalid.
<b>Wrong Password!</b>	The password you input was incorrect.
<b>Wrong Word Clock!</b>	The QL series console cannot synchronize because the source selected by MASTER CLOCK SELECT in the WORD CLOCK screen is not appropriate.
<b>You Cannot Create User Key.</b>	The current user does not have permission to create a user authentication key.

# Index

## A

Audio file (links to a scene recall)..... 84  
 Automixer ..... 109

## C

Calibration function..... 210, 211, 213  
 Cascade connections ..... 186  
 Channel color ..... 25, 190  
 Channel Job ..... 56  
 Channel library ..... 39, 48  
 Channel Link ..... 64  
 Channel name displays ..... 190  
 Console Lock..... 176  
 Control change ..... 143  
 Copying, moving, or initializing a channel ..... 67  
 Cue function ..... 87, 91  
     Operating..... 92  
 Custom fader bank ..... 175

## D

Dante audio network ..... 14, 192  
 DAW ..... 152  
 DCA group..... 56  
 Directly outputting..... 21  
 Dynamics..... 49, 52  
     Libraries..... 55

## E

Effect ..... 103  
     Libraries..... 126  
 Effects and tempo synchronization ..... 117  
 EQ ..... 49  
     Libraries..... 55  
 External device..... 18  
 External head amp ..... 127, 133

## F

Factory set..... 210  
 Fade function..... 82  
 Focus Recall function ..... 80  
 Function Tree ..... 4

## G

Gain ..... 26  
     Analog gain ..... 26  
 Gain Compensation ..... 30  
 Global Paste function..... 78  
 GPI..... 203  
 Graphic EQ ..... 103, 106  
     Libraries ..... 126

## H

HA (Head Amp)..... 26  
 Help function ..... 208  
     Viewing..... 208

## I

I/O device ..... 127  
 Input channels..... 23  
     Channel library ..... 39  
     Channel name and icon ..... 24  
     Sending to MIX/MATRIX bus ..... 34  
     Sending to STEREO/MONO bus ..... 30  
 Input Delay ..... 37  
 Input patch ..... 15  
 Inserting ..... 18  
 Internal clock ..... 191  
 Internal effects ..... 112  
 Internal head amp ..... 137

## L

Lamps ..... 190  
 LED ..... 190  
 LED color ..... 213  
 Library ..... 55, 126, 141

## M

MATRIX buses ..... 44, 189  
 METER screen..... 101  
 Meters ..... 101  
 MIDI ..... 138  
 MIX buses ..... 189  
 MIX channels  
     Sending to MATRIX buses..... 44  
     Sending to STEREO/MONO bus ..... 42  
 MIX/MATRIX buses ..... 34  
 Monitor function ..... 87, 88  
 Mute group..... 58

## N

Network address..... 191  
 Nuendo Live ..... 155

## O

Oscillator ..... 96, 98  
 Output channels ..... 40  
     Channel library..... 48  
     Channel name and icon ..... 41  
 Output Delay..... 46  
 Output patch ..... 16

## P

Parameter changes ..... 145  
 Patching..... 14  
 Pink frame (TOUCH AND TURN)..... 173  
 PORT TO PORT function ..... 47  
 Preferences ..... 167  
 Premium Rack  
     Libraries ..... 126  
     Operating ..... 119  
 Preview mode ..... 86  
 Program change ..... 141

## R

Recall Safe function..... 61

## S

Scene  
     Editing..... 75  
     Initializing ..... 210  
 SELECTED CHANNEL section ..... 6  
 SELECTED CHANNEL VIEW screen ..... 6  
 SETUP screen..... 159  
 Slot ..... 184  
 STEREO/MONO buses ..... 30, 42  
 STEREO/MONO channels  
     Sending to MATRIX buses ..... 44

## T

Talkback ..... 96  
 Title list ..... 151  
 TOUCH AND TURN ..... 173  
 Touch screen..... 190

## U

USB flash drive  
     Formatting ..... 183  
     Loading a file ..... 180  
     Loading Help/text file ..... 208  
     Playing back audio files ..... 150  
     Recording ..... 148  
     Saving and loading setup data ..... 177  
 USB memory recorder..... 146  
     Assigning channels ..... 146  
 USER DEFINED keys ..... 169  
     Functions that can be assigned..... 170  
     Recalling Help ..... 209  
 USER DEFINED knobs ..... 173  
     Functions that can be assigned..... 174  
 User settings ..... 160

## V

Virtual rack ..... 103  
     operations..... 103

## W

Warning/Error Messages..... 215  
 WIRELESS..... 132  
 Word clock..... 184





Yamaha Pro Audio Global Web Site  
<http://www.yamahaproaudio.com/>  
Yamaha Manual Library  
<http://www.yamaha.co.jp/manual/>

C.S.G., PA Development Division  
© 2014 Yamaha Corporation

402MA-A0



## DIGITAL MIXING CONSOLE

---

# QL5 QL1

## Data List

### Contents

EQ Library List.....	2
DYNAMICS Library List .....	3
Dynamics Parameters.....	5
Effect Type List.....	7
Effects Parameters.....	8
Premium Rack Processor Parameters .....	20
Parameters that can be assigned to control changes .....	22
NRPN parameter assignments .....	24
Mixing parameter operation applicability .....	28
MIDI Data Format .....	33
Input/Output Specifications.....	40
Electrical characteristics .....	41
Mixer Basic Parameters.....	42
Pin Assignment Chart.....	43
MIDI Implementation Chart.....	44

# EQ Library List

#	Title	Parameter			
		LOW	L-MID	H-MID	HIGH
01	Bass Drum 1	PEAKING	PEAKING	PEAKING	H.SHELF
		G +3.5 dB	-3.5 dB	0.0 dB	+4.0 dB
		F 100 Hz	265 Hz	1.06 kHz	5.30 kHz
		Q 1.25	10.0	0.90	—
02	Bass Drum 2	PEAKING	PEAKING	PEAKING	LPF
		G +8.0 dB	-7.0 dB	+6.0 dB	ON
		F 80.0 Hz	400 Hz	2.50 kHz	12.5 kHz
		Q 1.4	4.5	2.2	—
03	Snare Drum 1	PEAKING	PEAKING	PEAKING	H.SHELF
		G -0.5 dB	0.0 dB	+3.0 dB	+4.5 dB
		F 132 Hz	1.00 kHz	3.15 kHz	5.00 kHz
		Q 1.25	4.5	0.11	—
04	Snare Drum 2	L.SHELF	PEAKING	PEAKING	PEAKING
		G +1.5 dB	-8.5 dB	+2.5 dB	+4.0 dB
		F 180 Hz	335 Hz	2.36 kHz	4.00 kHz
		Q —	10.0	0.70	0.10
05	Tom-tom 1	PEAKING	PEAKING	PEAKING	PEAKING
		G +2.0 dB	-7.5 dB	+2.0 dB	+1.0 dB
		F 212 Hz	670 Hz	4.50 kHz	6.30 kHz
		Q 1.4	10.0	1.25	0.28
06	Cymbal	L.SHELF	PEAKING	PEAKING	H.SHELF
		G -2.0 dB	0.0 dB	0.0 dB	+3.0 dB
		F 106 Hz	425 Hz	1.06 kHz	13.2 kHz
		Q —	8.0	0.90	—
07	High Hat	L.SHELF	PEAKING	PEAKING	H.SHELF
		G -4.0 dB	-2.5 dB	+1.0 dB	+0.5 dB
		F 95.0 Hz	425 Hz	2.80 kHz	7.50 kHz
		Q —	0.50	1.0	—
08	Percussion	L.SHELF	PEAKING	PEAKING	H.SHELF
		G -4.5 dB	0.0 dB	+2.0 dB	0.0 dB
		F 100 Hz	400 Hz	2.80 kHz	17.0 kHz
		Q —	4.5	0.56	—
09	E. Bass 1	L.SHELF	PEAKING	PEAKING	H.SHELF
		G -7.5 dB	+4.5 dB	+2.5 dB	0.0 dB
		F 35.5 Hz	112 Hz	2.00 kHz	4.00 kHz
		Q —	5.0	4.5	—
10	E. Bass 2	PEAKING	PEAKING	PEAKING	H.SHELF
		G +3.0 dB	0.0 dB	+2.5 dB	+0.5 dB
		F 112 Hz	112 Hz	2.24 kHz	4.00 kHz
		Q 0.10	5.0	6.3	—

#	Title	Parameter			
		LOW	L-MID	H-MID	HIGH
11	Syn. Bass 1	PEAKING	PEAKING	PEAKING	H.SHELF
		G +3.5 dB	+8.5 dB	0.0 dB	0.0 dB
		F 85.0 Hz	950 Hz	4.00 kHz	12.5 kHz
		Q 0.10	8.0	4.5	—
12	Syn. Bass 2	PEAKING	PEAKING	PEAKING	H.SHELF
		G +2.5 dB	0.0 dB	+1.5 dB	0.0 dB
		F 125 Hz	180 Hz	1.12 kHz	12.5 kHz
		Q 1.6	8.0	2.2	—
13	Piano 1	L.SHELF	PEAKING	PEAKING	H.SHELF
		G -6.0 dB	0.0 dB	+2.0 dB	+4.0 dB
		F 95.0 Hz	950 Hz	3.15 kHz	7.50 kHz
		Q —	8.0	0.90	—
14	Piano 2	PEAKING	PEAKING	PEAKING	H.SHELF
		G +3.5 dB	-8.5 dB	+1.5 dB	+3.0 dB
		F 224 Hz	600 Hz	3.15 kHz	5.30 kHz
		Q 5.6	10.0	0.70	—
15	E. G. Clean	PEAKING	PEAKING	PEAKING	H.SHELF
		G +2.0 dB	-5.5 dB	+0.5 dB	+2.5 dB
		F 265 Hz	400 Hz	1.32 kHz	4.50 kHz
		Q 0.18	10.0	6.3	—
16	E. G. Crunch 1	PEAKING	PEAKING	PEAKING	PEAKING
		G +4.5 dB	0.0 dB	+4.0 dB	+2.0 dB
		F 140 Hz	1.00 kHz	1.90 kHz	5.60 kHz
		Q 8.0	4.5	0.63	9.0
17	E. G. Crunch 2	PEAKING	PEAKING	PEAKING	H.SHELF
		G +2.5 dB	+1.5 dB	+2.5 dB	0.0 dB
		F 125 Hz	450 Hz	3.35 kHz	19.0 kHz
		Q 8.0	0.40	0.16	—
18	E. G. Dist. 1	L.SHELF	PEAKING	PEAKING	H.SHELF
		G +5.0 dB	0.0 dB	+3.5 dB	0.0 dB
		F 355 Hz	950 Hz	3.35 kHz	12.5 kHz
		Q —	9.0	10.0	—
19	E. G. Dist. 2	L.SHELF	PEAKING	PEAKING	H.SHELF
		G +6.0 dB	-8.5 dB	+4.5 dB	+4.0 dB
		F 315 Hz	1.06 kHz	4.25 kHz	12.5 kHz
		Q —	10.0	4.0	—
20	A. G. Stroke 1	PEAKING	PEAKING	PEAKING	H.SHELF
		G -2.0 dB	0.0 dB	+1.0 dB	+4.0 dB
		F 106 Hz	1.00 kHz	1.90 kHz	5.30 kHz
		Q 0.90	4.5	3.5	—
21	A. G. Stroke 2	L.SHELF	PEAKING	PEAKING	H.SHELF
		G -3.5 dB	-2.0 dB	0.0 dB	+2.0 dB
		F 300 Hz	750 Hz	2.00 kHz	3.55 kHz
		Q —	9.0	4.5	—

#	Title	Parameter			
		LOW	L-MID	H-MID	HIGH
22	A. G. Arpeg. 1	L.SHELF	PEAKING	PEAKING	PEAKING
		G -0.5 dB	0.0 dB	0.0 dB	+2.0 dB
		F 224 Hz	1.00 kHz	4.00 kHz	6.70 kHz
		Q —	4.5	4.5	0.125
23	A. G. Arpeg. 2	L.SHELF	PEAKING	PEAKING	H.SHELF
		G 0.0 dB	-5.5 dB	0.0 dB	+4.0 dB
		F 180 Hz	355 Hz	4.00 kHz	4.25 kHz
		Q —	7.0	4.5	—
24	Brass Sec.	PEAKING	PEAKING	PEAKING	PEAKING
		G -2.0 dB	-1.0 dB	+1.5 dB	+3.0 dB
		F 90.0 Hz	850 Hz	2.12 kHz	4.50 kHz
		Q 2.8	2.0	0.70	7.0
25	Male Vocal 1	PEAKING	PEAKING	PEAKING	PEAKING
		G -0.5 dB	0.0 dB	+2.0 dB	+3.5 dB
		F 190 Hz	1.00 kHz	2.00 kHz	6.70 kHz
		Q 0.11	4.5	0.56	0.11
26	Male Vocal 2	PEAKING	PEAKING	PEAKING	H.SHELF
		G +2.0 dB	-5.0 dB	-2.5 dB	+4.0 dB
		F 170 Hz	236 Hz	2.65 kHz	6.70 kHz
		Q 0.11	10.0	5.6	—
27	Female Vo. 1	PEAKING	PEAKING	PEAKING	PEAKING
		G -1.0 dB	+1.0 dB	+1.5 dB	+2.0 dB
		F 118 Hz	400 Hz	2.65 kHz	6.00 kHz
		Q 0.18	0.45	0.56	0.14
28	Female Vo. 2	L.SHELF	PEAKING	PEAKING	H.SHELF
		G -7.0 dB	+1.5 dB	+1.5 dB	+2.5 dB
		F 112 Hz	335 Hz	2.00 kHz	6.70 kHz
		Q —	0.16	0.20	—
29	Chorus & Harmo	PEAKING	PEAKING	PEAKING	PEAKING
		G -2.0 dB	-1.0 dB	+1.5 dB	+3.0 dB
		F 90.0 Hz	850 Hz	2.12 kHz	4.50 kHz
		Q 2.8	2.0	0.70	7.0
30	Total EQ 1	PEAKING	PEAKING	PEAKING	H.SHELF
		G -0.5 dB	0.0 dB	+3.0 dB	+6.5 dB
		F 95.0 Hz	950 Hz	2.12 kHz	16.0 kHz
		Q 7.0	2.2	5.6	—
31	Total EQ 2	PEAKING	PEAKING	PEAKING	H.SHELF
		G +4.0 dB	+1.5 dB	+2.0 dB	+6.0 dB
		F 95.0 Hz	750 Hz	1.80 kHz	18.0 kHz
		Q 7.0	2.8	5.6	—
32	Total EQ 3	L.SHELF	PEAKING	PEAKING	H.SHELF
		G +1.5 dB	+0.5 dB	+2.0 dB	+4.0 dB
		F 67.0 Hz	850 Hz	1.90 kHz	15.0 kHz
		Q —	0.28	0.70	—

#	Title	Parameter				
		LOW	L-MID	H-MID	HIGH	
33	Bass Drum 3		PEAKING	PEAKING	PEAKING	PEAKING
		G	+3.5 dB	-10.0 dB	+3.5 dB	0.0 dB
		F	118 Hz	315 Hz	4.25 kHz	20.0 kHz
		Q	2.0	10.0	0.40	0.40
34	Snare Drum 3		L.SHELF	PEAKING	PEAKING	PEAKING
		G	0.0 dB	+2.0 dB	+3.5 dB	0.0 dB
		F	224 Hz	560 Hz	4.25 kHz	4.00 kHz
		Q	—	4.5	2.8	0.10
35	Tom-tom 2		L.SHELF	PEAKING	PEAKING	H.SHELF
		G	-9.0 dB	+1.5 dB	+2.0 dB	0.0 dB
		F	90.0 Hz	212 Hz	5.30 kHz	17.0 kHz
		Q	—	4.5	1.25	—
36	Piano 3		PEAKING	PEAKING	PEAKING	H.SHELF
		G	+4.5 dB	-13.0 dB	+4.5 dB	+2.5 dB
		F	100 Hz	475 Hz	2.36 kHz	10.0 kHz
		Q	8.0	10.0	9.0	—
37	Piano Low		PEAKING	PEAKING	PEAKING	H.SHELF
		G	-5.5 dB	+1.5 dB	+6.0 dB	0.0 dB
		F	190 Hz	400 Hz	6.70 kHz	12.5 kHz
		Q	10.0	6.3	2.2	—
38	Piano High		PEAKING	PEAKING	PEAKING	PEAKING
		G	-5.5 dB	+1.5 dB	+5.0 dB	+3.0 dB
		F	190 Hz	400 Hz	6.70 kHz	5.60 kHz
		Q	10.0	6.3	2.2	0.10
39	Fine-EQ Cass		L.SHELF	PEAKING	PEAKING	H.SHELF
		G	-1.5 dB	0.0 dB	+1.0 dB	+3.0 dB
		F	75.0 Hz	1.00 kHz	4.00 kHz	12.5 kHz
		Q	—	4.5	1.8	—
40	Narrator		PEAKING	PEAKING	PEAKING	H.SHELF
		G	-4.0 dB	-1.0 dB	+2.0 dB	0.0 dB
		F	106 Hz	710 Hz	2.50 kHz	10.0 kHz
		Q	4.0	7.0	0.63	—

## DYNAMICS Library List

#	Title	Type	Parameter	Value			
1	Gate	GATE	Threshold (dB)	-26			
			Range (dB)	-56			
			Attack (ms)	0			
			Hold (ms)	2.56			
			Decay (ms)	331			
2	Ducking	DUCKING	Threshold (dB)	-19			
			Range (dB)	-22			
			Attack (ms)	93			
			Hold (ms)	1.20 S			
			Decay (ms)	6.32 S			
3	A. Dr. BD	GATE	Threshold (dB)	-11			
			Range (dB)	-53			
			Attack (ms)	0			
			Hold (ms)	1.93			
			Decay (ms)	400			
4	A. Dr. SN	GATE	Threshold (dB)	-8			
			Range (dB)	-23			
			Attack (ms)	1			
			Decay (ms)	238			
5	De-Esser	DE-ESSER	Threshold (dB)	-8			
			Frequency (kHz)	2.00			
			Type	HPF			
			Q	1.6			
			6	Comp	COMPRESSOR	Threshold (dB)	-8
						Ratio ( :1)	2.5
Attack (ms)	30						
Out gain (dB)	0.0						
Knee	2						
Release (ms)	250						
7	Expand	EXPANDER	Threshold (dB)	-23			
			Ratio ( :1)	1.7			
			Attack (ms)	1			
			Out gain (dB)	3.5			
			Knee	2			
Release (ms)	70						
8	Compander (H)	COMPANDER-H	Threshold (dB)	-10			
			Ratio ( :1)	3.5			
			Attack (ms)	1			
			Out gain (dB)	0.0			
			Width (dB)	6			
Release (ms)	250						
9	Compander (S)	COMPANDER-S	Threshold (dB)	-8			
			Ratio ( :1)	4			
			Attack (ms)	25			
			Out gain (dB)	0.0			
			Width (dB)	24			
Release (ms)	180						

#	Title	Type	Parameter	Value
10	A. Dr. BD	COMPRESSOR	Threshold (dB)	-24
			Ratio ( :1)	3
			Attack (ms)	9
			Out gain (dB)	5.5
			Knee	2
			Release (ms)	58
11	A. Dr. BD	COMPANDER-H	Threshold (dB)	-11
			Ratio ( :1)	3.5
			Attack (ms)	1
			Out gain (dB)	-1.5
			Width (dB)	7
Release (ms)	192			
12	A. Dr. SN	COMPRESSOR	Threshold (dB)	-17
			Ratio ( :1)	2.5
			Attack (ms)	8
			Out gain (dB)	3.5
			Knee	2
Release (ms)	12			
13	A. Dr. SN	EXPANDER	Threshold (dB)	-23
			Ratio ( :1)	2
			Attack (ms)	0
			Out gain (dB)	0.5
			Knee	2
Release (ms)	151			
14	A. Dr. SN	COMPANDER-S	Threshold (dB)	-8
			Ratio ( :1)	1.7
			Attack (ms)	11
			Out gain (dB)	0.0
			Width (dB)	10
Release (ms)	128			
15	A. Dr. Tom	EXPANDER	Threshold (dB)	-20
			Ratio ( :1)	2
			Attack (ms)	2
			Out gain (dB)	5.0
			Knee	2
Release (ms)	749			
16	A. Dr. OverTop	COMPANDER-S	Threshold (dB)	-24
			Ratio ( :1)	2
			Attack (ms)	38
			Out gain (dB)	-3.5
			Width (dB)	54
Release (ms)	842			
17	E. B. Finger	COMPRESSOR	Threshold (dB)	-12
			Ratio ( :1)	2
			Attack (ms)	15
			Out gain (dB)	4.5
			Knee	2
Release (ms)	470			

#	Title	Type	Parameter	Value
18	E. B. Slap	COMPRESSOR	Threshold (dB)	-12
			Ratio ( :1)	1.7
			Attack (ms)	6
			Out gain (dB)	4.0
			Knee	hard
			Release (ms)	133
19	Syn. Bass	COMPRESSOR	Threshold (dB)	-10
			Ratio ( :1)	3.5
			Attack (ms)	9
			Out gain (dB)	3.0
			Knee	hard
			Release (ms)	250
20	Piano1	COMPRESSOR	Threshold (dB)	-9
			Ratio ( :1)	2.5
			Attack (ms)	17
			Out gain (dB)	1.0
			Knee	hard
			Release (ms)	238
21	Piano2	COMPRESSOR	Threshold (dB)	-18
			Ratio ( :1)	3.5
			Attack (ms)	7
			Out gain (dB)	6.0
			Knee	2
			Release (ms)	174
22	E. Guitar	COMPRESSOR	Threshold (dB)	-8
			Ratio ( :1)	3.5
			Attack (ms)	7
			Out gain (dB)	2.5
			Knee	4
			Release (ms)	261
23	A. Guitar	COMPRESSOR	Threshold (dB)	-10
			Ratio ( :1)	2.5
			Attack (ms)	5
			Out gain (dB)	1.5
			Knee	2
			Release (ms)	238
24	Strings1	COMPRESSOR	Threshold (dB)	-11
			Ratio ( :1)	2
			Attack (ms)	33
			Out gain (dB)	1.5
			Knee	2
			Release (ms)	749
25	Strings2	COMPRESSOR	Threshold (dB)	-12
			Ratio ( :1)	1.5
			Attack (ms)	93
			Out gain (dB)	1.5
			Knee	4
			Release (ms)	1.35 S

#	Title	Type	Parameter	Value
26	Strings3	COMPRESSOR	Threshold (dB)	-17
			Ratio ( :1)	1.5
			Attack (ms)	76
			Out gain (dB)	2.5
			Knee	2
			Release (ms)	186
27	BrassSection	COMPRESSOR	Threshold (dB)	-18
			Ratio ( :1)	1.7
			Attack (ms)	18
			Out gain (dB)	4.0
			Knee	1
			Release (ms)	226
28	Syn. Pad	COMPRESSOR	Threshold (dB)	-13
			Ratio ( :1)	2
			Attack (ms)	58
			Out gain (dB)	2.0
			Knee	1
			Release (ms)	238
29	SamplingPerc	COMPANDER-S	Threshold (dB)	-18
			Ratio ( :1)	1.7
			Attack (ms)	8
			Out gain (dB)	-2.5
			Width (dB)	18
			Release (ms)	238
30	Sampling BD	COMPRESSOR	Threshold (dB)	-14
			Ratio ( :1)	2
			Attack (ms)	2
			Out gain (dB)	3.5
			Knee	4
			Release (ms)	35
31	Sampling SN	COMPRESSOR	Threshold (dB)	-18
			Ratio ( :1)	4
			Attack (ms)	8
			Out gain (dB)	8.0
			Knee	hard
			Release (ms)	354
32	Hip Comp	COMPANDER-S	Threshold (dB)	-23
			Ratio ( :1)	20
			Attack (ms)	15
			Out gain (dB)	0.0
			Width (dB)	15
			Release (ms)	163
33	Solo Vocal1	COMPRESSOR	Threshold (dB)	-20
			Ratio ( :1)	2.5
			Attack (ms)	31
			Out gain (dB)	2.0
			Knee	1
			Release (ms)	342

#	Title	Type	Parameter	Value
34	Solo Vocal2	COMPRESSOR	Threshold (dB)	-8
			Ratio ( :1)	2.5
			Attack (ms)	26
			Out gain (dB)	1.5
			Knee	3
			Release (ms)	331
35	Chorus	COMPRESSOR	Threshold (dB)	-9
			Ratio ( :1)	1.7
			Attack (ms)	39
			Out gain (dB)	2.5
			Knee	2
			Release (ms)	226
36	Click Erase	EXPANDER	Threshold (dB)	-33
			Ratio ( :1)	2
			Attack (ms)	1
			Out gain (dB)	2.0
			Knee	2
			Release (ms)	284
37	Announcer	COMPANDER-H	Threshold (dB)	-14
			Ratio ( :1)	2.5
			Attack (ms)	1
			Out gain (dB)	-2.5
			Width (dB)	18
			Release (ms)	180
38	Limiter1	COMPANDER-S	Threshold (dB)	-9
			Ratio ( :1)	3
			Attack (ms)	20
			Out gain (dB)	-3.0
			Width (dB)	90
			Release (ms)	3.90 s
39	Limiter2	COMPRESSOR	Threshold (dB)	0
			Ratio ( :1)	∞
			Attack (ms)	0
			Out gain (dB)	0.0
			Knee	hard
			Release (ms)	319
40	Total Comp1	COMPRESSOR	Threshold (dB)	-18
			Ratio ( :1)	3.5
			Attack (ms)	94
			Out gain (dB)	2.5
			Knee	hard
			Release (ms)	447
41	Total Comp2	COMPRESSOR	Threshold (dB)	-16
			Ratio ( :1)	6
			Attack (ms)	11
			Out gain (dB)	6.0
			Knee	1
			Release (ms)	180

\* At fs=44.1 kHz

## Dynamics Parameters

Dynamics Parameters are the following types.

	Input channels		Output channels
	DYNAMIC section 1	DYNAMIC section 2	DYNAMIC section 1
Type	GATE	COMPRESSOR	COMPRESSOR
	DUCKING	COMPANDER-H (Compander Hard)	EXPANDER
	COMPRESSOR	COMPANDER-S (Compander Soft)	COMPANDER-H (Compander Hard)
	EXPANDER	DE-ESSER	COMPANDER-S (Compander Soft)

### ■ GATE

A gate attenuates signals below a set THRESHOLD level by a specified amount (RANGE).

Parameter	Range	Description
THRESHOLD (dB)	-72 to 0 (73 points)	This determines the level at which the gate effect is applied.
RANGE (dB)	-∞, -69 to 0 (71 points)	This determines the amount of attenuation when the gate closes.
ATTACK (ms)	0-120 (121 points)	This determines how fast the gate opens when the signal exceeds the threshold level.
HOLD (ms)	44.1kHz: 0.02 ms – 2.13 sec 48kHz: 0.02 ms – 1.96 sec (160 points)	This determines how long the gate stays open once the trigger signal has fallen below the threshold.
DECAY (ms)	44.1kHz: 6 ms – 46.0 sec 48kHz: 5 ms – 42.3 sec (160 points)	This determines how fast the gate closes once the hold time has expired. The value is expressed as the duration required for the level to change by 6 dB.

#### • I/O Characteristics

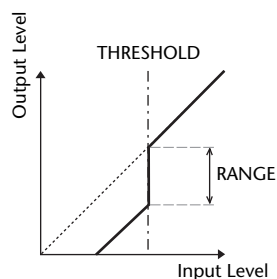

#### • Time Series Analysis

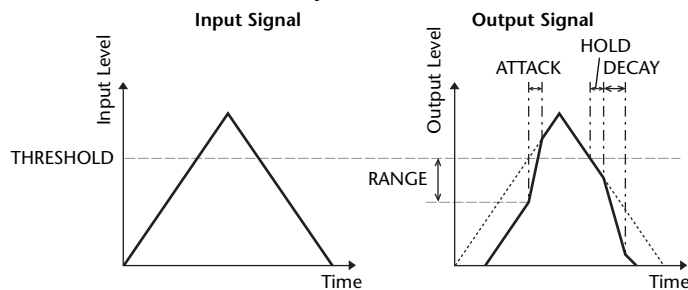

### ■ DUCKING

Ducking is commonly used for voice-over applications in which the background music level is reduced automatically when an announcer speaks.

When the KEY IN source signal level exceeds the specified THRESHOLD, the output level is attenuated by a specified amount (RANGE).

Parameter	Range	Description
THRESHOLD (dB)	-54 to 0 (55 points)	This determines the level of trigger signal (KEY IN) required to activate ducking.
RANGE (dB)	-70 to 0 (71 points)	This determines the amount of attenuation when ducking is activated.
ATTACK (ms)	0-120 (121 points)	This determines how soon the signal is ducked once the ducker has been triggered.
HOLD (ms)	44.1kHz: 0.02 ms – 2.13 sec 48kHz: 0.02 ms – 1.96 sec (160 points)	This determines how long ducking remains active once the trigger signal has fallen below the THRESHOLD level.
DECAY (ms)	44.1kHz: 6 ms – 46.0 sec 48kHz: 5 ms – 42.3 sec (160 points)	This determines how soon the ducker returns to its normal gain once the trigger signal level drops below the threshold. The value is expressed as the duration required for the level to change by 6 dB.

#### • I/O Characteristics

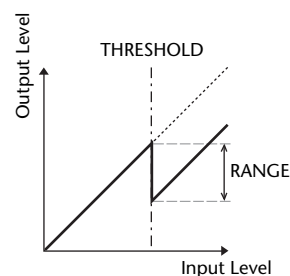

#### • Time Series Analysis

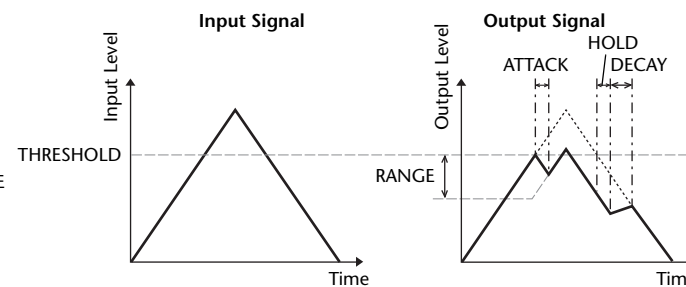

## COMPRESSOR

The COMP processor attenuates signals above a specified THRESHOLD by a specified RATIO.

The COMP processor can also be used as a limiter, which, with a RATIO of  $\infty:1$ , reduces the level to the threshold. This means that the limiter's output level never actually exceeds the threshold.

Parameter	Range	Description
THRESHOLD (dB)	-54 to 0 (55 points)	This determines the level of input signal required to trigger the compressor.
RATIO	1.0:1, 1.1:1, 1.3:1, 1.5:1, 1.7:1, 2.0:1, 2.5:1, 3.0:1, 3.5:1, 4.0:1, 5.0:1, 6.0:1, 8.0:1, 10:1, 20:1, $\infty:1$ (16 points)	This determines the amount of compression, that is, the change in output signal level relative to change in input signal level.
ATTACK (ms)	0-120 (121 points)	This determines how soon the signal will be compressed once the compressor has been triggered.
RELEASE (ms)	44.1kHz: 6 ms - 46.0 sec 48kHz: 5 ms - 42.3 sec (160 points)	This determines how soon the compressor returns to its normal gain once the trigger signal level drops below the threshold. The value is expressed as the duration required for the level to change by 6 dB.
OUT GAIN (dB)	0.0 to +18.0 (181 points)	This sets the compressor's output signal level.
KNEE	Hard, 1-5 (6 points)	This determines how compression is applied at the threshold. For higher knee settings, compression is applied gradually as the signal exceeds the specified threshold, creating a more natural sound.

- I/O Characteristics (KNEE= hard, OUT GAIN= 0.0dB)

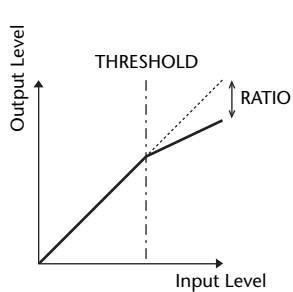

- Time Series Analysis (RATIO=  $\infty:1$ )

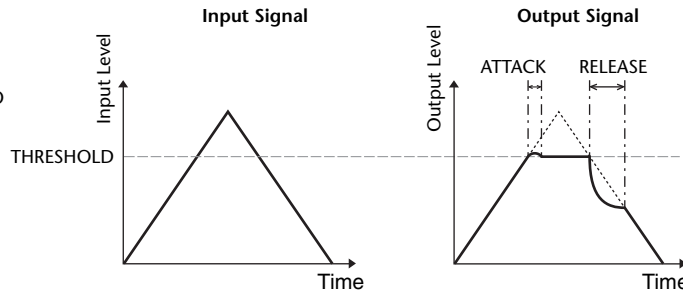

## EXPANDER

An expander attenuates signals below a specified THRESHOLD by a specified RATIO.

Parameter	Range	Description
THRESHOLD (dB)	-54 to 0 (55 points)	This determines the level of input signal required to trigger the expander.
RATIO	1.0:1, 1.1:1, 1.3:1, 1.5:1, 1.7:1, 2.0:1, 2.5:1, 3.0:1, 3.5:1, 4.0:1, 5.0:1, 6.0:1, 8.0:1, 10:1, 20:1, $\infty:1$ (16 points)	This determines the amount of expansion.
ATTACK (ms)	0-120 (121 points)	This determines how soon the expander returns to its normal gain once the trigger signal level exceeds the threshold.
RELEASE (ms)	44.1kHz: 6 ms - 46.0 sec 48kHz: 5 ms - 42.3 sec (160 points)	This determines how soon the signal is expanded once the signal level drops below the threshold. The value is expressed as the duration required for the level to change by 6 dB.
OUT GAIN (dB)	0.0 to +18.0 (181 points)	This sets the expander's output signal level.
KNEE	Hard, 1-5 (6 points)	This determines how expansion is applied at the threshold. For higher knee settings, expansion is applied gradually as the signal exceeds the specified threshold, creating a more natural sound.

- I/O Characteristics (KNEE= hard, OUT GAIN= 0.0dB)

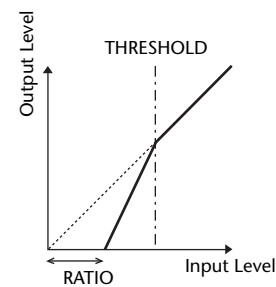

- Time Series Analysis (RATIO=  $\infty:1$ )

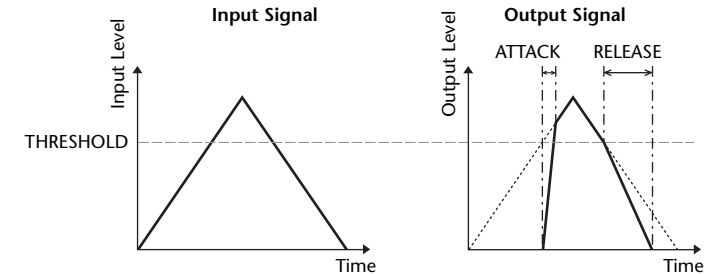



## ■ COMPANDER HARD (COMPANDER-H), COMPANDER SOFT (COMPANDER-S)

The hard and soft companders combine the effects of the compressor, expander and limiter.

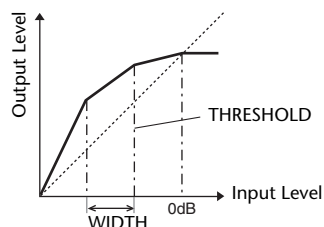

The companders function differently at the following levels:

- ① **0 dB and higher** .....Functions as a limiter.
- ② **Exceeding the threshold** .....Functions as a compressor.
- ③ **Below the threshold and width** .....Functions as an expander.

The hard compander has an expansion ratio of 5:1, while the soft compander has an expansion ratio of 1.5:1. The expander is essentially turned off when the width is set to maximum. The compressor has a fixed knee setting of 2.

\* The gain is automatically adjusted according to the ratio and threshold values, and can be increased by up to 18 dB.

\* The OUT GAIN parameter enables you to compensate for the overall level change caused by the compression and expansion processes.

Parameter	Range	Description
<b>THRESHOLD (dB)</b>	-54 to 0 (55 points)	This determines the level at which compression is applied.
<b>RATIO</b>	1.0:1, 1.1:1, 1.3:1, 1.5:1, 1.7:1, 2.0:1, 2.5:1, 3.0:1, 3.5:1, 4.0:1, 5.0:1, 6.0:1, 8.0:1, 10:1, 20:1 (15 points)	This determines the amount of compression.
<b>ATTACK (ms)</b>	0-120 (121 points)	This determines how soon the signal is compressed or expanded once the compander has been triggered.
<b>RELEASE (ms)</b>	44.1kHz: 6 ms - 46.0 sec 48kHz: 5 ms - 42.3 sec (160 points)	This determines how soon the compressor or expander returns to the normal gain once the trigger signal level drops below or exceeds the threshold respectively. The value is expressed as the duration required for the level to change by 6 dB.
<b>OUT GAIN (dB)</b>	-18.0 to 0.0 (181 points)	This sets the compander's output signal level.
<b>WIDTH (dB)</b>	1-90 (90 points)	This determines how far below the threshold expansion will be applied. The expander is activated when the level drops below the threshold and width.

## ■ DE-ESSER

This detects and compresses only the sibilants and other high-frequency consonants of the vocal.

Parameter	Range	Description
<b>THRESHOLD</b>	-54 to 0 (55 points)	Threshold level at which the de-esser effect is applied.
<b>FREQUENCY</b>	1kHz-12.5kHz (45 points)	Cutoff frequency of the filter used to detect the high frequencies.
<b>TYPE</b>	HPF, BPF	Type of filter used to detect the frequency band.
<b>Q</b>	10.0-0.10 (41 points)	Q (steepness) of the filter when TYPE is BPF.

## Effect Type List

Title	Type	Description
REV-X Hall	REV-X HALL	New reverb algorithm that delivers dense and rich reverberation, smooth decay, and provides a spaciousness and depth that enhances the original sound. Choose from three types depending on your location and needs; REV-X HALL, REV-X ROOM, and REV-X PLATE.
REV-X Room	REV-X ROOM	
REV-X Plate	REV-X PLATE	
Reverb Hall	REVERB HALL	Concert hall reverberation simulation with gate
Reverb Room	REVERB ROOM	Room reverberation simulation with gate
Reverb Stage	REVERB STAGE	Reverb designed for vocals, with gate
Reverb Plate	REVERB PLATE	Plate reverb simulation with gate
Stereo Reverb	ST REVERB	Stereo reverb
Early Ref.	EARLY REF.	Early reflections without the subsequent reverb
Gate Reverb	GATE REVERB	Gated early reflections
Reverse Gate	REVERSE GATE	Gated reverse early reflections
Mono Delay	MONO DELAY	Simple mono delay
Stereo Delay	STEREO DELAY	Simple stereo delay
Mod.Delay	MOD.DELAY	Simple repeat delay with modulation
Delay LCR	DELAY LCR	3-tap (left, center, right) delay
Echo	ECHO	Stereo delay with crossed left/right feedback
Chorus	CHORUS	Chorus
Flange	FLANGE	Flanger
Symphonic	SYMPHONIC	Proprietary Yamaha effect that produces a richer and more complex modulation than normal chorus
Phaser	PHASER	16-stage stereo phase shifter
Dyna.Flange	DYNA.FLANGE	Dynamically controlled flanger
Dyna.Phaser	DYNA.PHASER	Dynamically controlled phase shifter
HQ. Pitch	HQ.PITCH	Mono pitch shifter, producing stable results
Dual Pitch	DUAL PITCH	Stereo pitch shifter
Tremolo	TREMOLO	Tremolo
Auto Pan	AUTO PAN	Auto-panner
Rotary	ROTARY	Rotary speaker simulation
Ring Mod.	RING MOD.	Ring modulator
Mod.Filter	MOD.FILTER	Modulated filter
Dyna.Filter	DYNA.FILTER	Dynamically controlled filter
Rev+Chorus	REV+CHORUS	Reverb and chorus in parallel
Rev→Chorus	REV→CHORUS	Reverb and chorus in series
Rev+Flange	REV+FLANGE	Reverb and flanger in parallel
Rev→Flange	REV→FLANGE	Reverb and flanger in series
Rev+Sympho.	REV+SYMPHO.	Reverb and symphonic in parallel
Rev→Sympho.	REV→SYMPHO.	Reverb and symphonic in series
Rev→Pan	REV→PAN	Reverb and auto-pan in series
Delay+Er.	DELAY+ER.	Delay and early reflections in parallel

Title	Type	Description
Delay→Er.	DELAY→ER.	Delay and early reflections in series
Delay+Rev	DELAY+REV	Delay and reverb in parallel
Delay→Rev	DELAY→REV	Delay and reverb in series
Dist→Delay	DIST→DELAY	Distortion and delay in series
Multi Filter	MULTI FILTER	3-band parallel filter (24 dB/octave)
Freeze	FREEZE	Simple sampler
Distortion	DISTORTION	Distortion
Amp Simulate	AMP SIMULATE	Guitar amp simulation
Comp276	COMP276	This compressor emulates the characteristics of an analog compressor that has become a sought-after classic in recording studios.
Comp276S	COMP276S	This is a stereo model of COMP276.
Comp260	COMP260	This compressor emulates the characteristics of a compressor/limiter of the latter 1970s that has become a sought-after classic for live SR.
Comp260S	COMP260S	This is a stereo model of the COMP260.
Equalizer601	EQUALIZER601	This equalizer emulates the characteristics of an analog equalizer of the 1970s. It can be used to obtain a sense of drive.
OpenDeck	OPENDECK	This is a tape saturation effect that emulates the tape compression produced by two open-reel tape recorders: a recording deck and a reproduction deck.
M.Band Dyna.	M.BAND DYNA.	Multi-band dynamics processor
M.Band Comp	M.BAND COMP	Multi-band compressor

## Effects Parameters

### ■ REV-X HALL, REV-X ROOM, REV-X PLATE

Newly-developed two input, two output reverb algorithm. Delivers dense and rich reverberation, smooth decay, and provides a spaciousness and depth that enhances the original sound. Choose from three types depending on your location and needs; REV-X HALL, REV-X ROOM, and REV-X PLATE.

Parameter	Range	Description
REV TIME	0.28–27.94 s <sup>*1</sup>	Reverb time
INI. DLY	0.0–120.0 ms	Initial delay before reverb begins
HI. RATIO	0.1–1.0	High-frequency reverb time ratio
LO. RATIO	0.1–1.4	Low-frequency reverb time ratio
LO.FREQ	22.0 Hz–18.0 kHz	Frequency point for LO.RATIO setting
DIFF.	0–10	Reverb diffusion (left-right reverb spread)
ROOM SIZE	0–28	Size of room
DECAY	0–53	Gate closing speed
HPF	THRU, 22.0 Hz–8.00 kHz	High-pass filter cutoff frequency
LPF	1.00 kHz–18.0 kHz, THRU	Low-pass filter cutoff frequency

\*1. These values are for when the effect type is REV-X HALL and the ROOM SIZE=28. The range will differ depending on the effect type and ROOM SIZE setting.

### ■ REVERB HALL, REVERB ROOM, REVERB STAGE, REVERB PLATE

One input, two output hall, room, stage, and plate reverb simulations, all with gates.

Parameter	Range	Description
REV TIME	0.3–99.0 s	Reverb time
INI. DLY	0.0–500.0 ms	Initial delay before reverb begins
HI. RATIO	0.1–1.0	High-frequency reverb time ratio
LO. RATIO	0.1–2.4	Low-frequency reverb time ratio
DIFF.	0–10	Reverb diffusion (left-right reverb spread)
DENSITY	0–100%	Reverb density
E/R DLY	0.0–100.0 ms	Delay between early reflections and reverb
E/R BAL.	0–100%	Balance of early reflections and reverb (0% = all reverb, 100% = all early reflections)
HPF	THRU, 21.2 Hz–8.00 kHz	High-pass filter cutoff frequency
LPF	50.0 Hz–16.0 kHz, THRU	Low-pass filter cutoff frequency
GATE LVL	OFF, –60 to 0 dB	Level at which gate kicks in
ATTACK	0–120 ms	Gate opening speed
HOLD	*1	Gate open time
DECAY	*2	Gate closing speed

\*1. 0.02 ms–2.13 s (fs=44.1 kHz), 0.02 ms–1.96 s (fs=48 kHz)

\*2. 6.0 ms–46.0 s (fs=44.1 kHz), 5.0 ms–42.3 s (fs=48 kHz)

## ■ STEREO REVERB

Two input, two output stereo reverb.

Parameter	Range	Description
REV TIME	0.3–99.0 s	Reverb time
REV TYPE	Hall, Room, Stage, Plate	Reverb type
INI. DLY	0.0–100.0 ms	Initial delay before reverb begins
HI. RATIO	0.1–1.0	High-frequency reverb time ratio
LO. RATIO	0.1–2.4	Low-frequency reverb time ratio
DIFF.	0–10	Reverb diffusion (left–right reverb spread)
DENSITY	0–100%	Reverb density
E/R BAL.	0–100%	Balance of early reflections and reverb (0% = all reverb, 100% = all early reflections)
HPF	THRU, 21.2 Hz–8.00 kHz	High-pass filter cutoff frequency
LPF	50.0 Hz–16.0 kHz, THRU	Low-pass filter cutoff frequency

## ■ EARLY REF.

One input, two output early reflections.

Parameter	Range	Description
TYPE	S-Hall, L-Hall, Random, Revers, Plate, Spring	Type of early reflection simulation
ROOMSIZE	0.1–20.0	Reflection spacing
LIVENESS	0–10	Early reflections decay characteristics (0 = dead, 10 = live)
INI. DLY	0.0–500.0 ms	Initial delay before reverb begins
DIFF.	0–10	Reflection diffusion (left–right reflection spread)
DENSITY	0–100%	Reflection density
ER NUM.	1–19	Number of early reflections
FB GAIN	–99 to +99%	Feedback gain
HI. RATIO	0.1–1.0	High-frequency feedback ratio
HPF	THRU, 21.2 Hz–8.00 kHz	High-pass filter cutoff frequency
LPF	50.0 Hz–16.0 kHz, THRU	Low-pass filter cutoff frequency

## ■ GATE REVERB, REVERSE GATE

One input, two output early reflections with gate, and early reflections with reverse gate.

Parameter	Range	Description
TYPE	Type-A, Type-B	Type of early reflection simulation
ROOMSIZE	0.1–20.0	Reflection spacing
LIVENESS	0–10	Early reflections decay characteristics (0 = dead, 10 = live)
INI. DLY	0.0–500.0 ms	Initial delay before reverb begins
DIFF.	0–10	Reflection diffusion (left–right reflection spread)
DENSITY	0–100%	Reflection density
HI. RATIO	0.1–1.0	High-frequency feedback ratio
ER NUM.	1–19	Number of early reflections
FB GAIN	–99 to +99%	Feedback gain
HPF	THRU, 21.2 Hz–8.00 kHz	High-pass filter cutoff frequency
LPF	50.0 Hz–16.0 kHz, THRU	Low-pass filter cutoff frequency

## ■ MONO DELAY

One input, one output basic repeat delay.

Parameter	Range	Description
DELAY	0.0–2730.0 ms	Delay time
FB. GAIN	–99 to +99%	Feedback gain (plus values for normal-phase feedback, minus values for reverse-phase feedback)
HI. RATIO	0.1–1.0	High-frequency feedback ratio
HPF	THRU, 21.2 Hz–8.00 kHz	High-pass filter cutoff frequency
LPF	50.0 Hz–16.0 kHz, THRU	Low-pass filter cutoff frequency
SYNC	OFF/ON	Tempo parameter sync on/off
NOTE	*1	Used in conjunction with TEMPO to determine DELAY

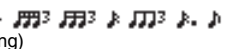
\*1.  (Maximum value depends on the tempo setting)

## ■ STEREO DELAY

Two input, two output basic stereo delay.

Parameter	Range	Description
DELAY L	0.0–1350.0 ms	Left channel delay time
DELAY R	0.0–1350.0 ms	Right channel delay time
FB. G L	–99 to +99%	Left channel feedback (plus values for normal-phase feedback, minus values for reverse-phase feedback)
FB. G R	–99 to +99%	Right channel feedback (plus values for normal-phase feedback, minus values for reverse-phase feedback)
HI. RATIO	0.1–1.0	High-frequency feedback ratio
HPF	THRU, 21.2 Hz–8.00 kHz	High-pass filter cutoff frequency
LPF	50.0 Hz–16.0 kHz, THRU	Low-pass filter cutoff frequency
SYNC	OFF/ON	Tempo parameter sync on/off
NOTE L	*1	Used in conjunction with TEMPO to determine left channel DELAY
NOTE R	*1	Used in conjunction with TEMPO to determine right channel DELAY

\*1.  (Maximum value depends on the tempo setting)

## MOD. DELAY

One input, two output basic repeat delay with modulation.

Parameter	Range	Description
DELAY	0.0–2725.0 ms	Delay time
FB. GAIN	–99 to +99%	Feedback gain (plus values for normal-phase feedback, minus values for reverse-phase feedback)
HI. RATIO	0.1–1.0	High-frequency feedback ratio
FREQ.	0.05–40.00 Hz	Modulation speed
DEPTH	0–100%	Modulation depth
WAVE	Sine/Tri	Modulation waveform
HPF	THRU, 21.2 Hz–8.00 kHz	High-pass filter cutoff frequency
LPF	50.0 Hz–16.0 kHz, THRU	Low-pass filter cutoff frequency
SYNC	OFF/ON	Tempo parameter sync on/off
DLY.NOTE	*1	Used in conjunction with TEMPO to determine DELAY
MOD.NOTE	*2	Used in conjunction with TEMPO to determine FREQ

\*1.  (Maximum value depends on the tempo setting)

\*2. 

## DELAY LCR

One input, two output 3-tap delay (left, center, right).

Parameter	Range	Description
DELAY L	0.0–2730.0 ms	Left channel delay time
DELAY C	0.0–2730.0 ms	Center channel delay time
DELAY R	0.0–2730.0 ms	Right channel delay time
FB. DLY	0.0–2730.0 ms	Feedback delay time
LEVEL L	–100 to +100%	Left channel delay level
LEVEL C	–100 to +100%	Center channel delay level
LEVEL R	–100 to +100%	Right channel delay level
FB. GAIN	–99 to +99%	Feedback gain (plus values for normal-phase feedback, minus values for reverse-phase feedback)
HI. RATIO	0.1–1.0	High-frequency feedback ratio
HPF	THRU, 21.2 Hz–8.00 kHz	High-pass filter cutoff frequency
LPF	50.0 Hz–16.0 kHz, THRU	Low-pass filter cutoff frequency
SYNC	OFF/ON	Tempo parameter sync on/off
NOTE L	*1	Used in conjunction with TEMPO to determine left channel DELAY
NOTE C	*1	Used in conjunction with TEMPO to determine center channel DELAY
NOTE R	*1	Used in conjunction with TEMPO to determine right channel DELAY
NOTE FB	*1	Used in conjunction with TEMPO to determine feedback DELAY

\*1.  (Maximum value depends on the tempo setting)

setting)

## ECHO

Two input, two output stereo delay with crossed feedback loop.

Parameter	Range	Description
DELAY L	0.0–1350.0 ms	Left channel delay time
DELAY R	0.0–1350.0 ms	Right channel delay time
FB.DLY L	0.0–1350.0 ms	Left channel feedback delay time
FB.DLY R	0.0–1350.0 ms	Right channel feedback delay time
FB. G L	–99 to +99%	Left channel feedback gain (plus values for normal-phase feedback, minus values for reverse-phase feedback)
FB. G R	–99 to +99%	Right channel feedback gain (plus values for normal-phase feedback, minus values for reverse-phase feedback)
L→R FBG	–99 to +99%	Left to right channel feedback gain (plus values for normal-phase feedback, minus values for reverse-phase feedback)
R→L FBG	–99 to +99%	Right to left channel feedback gain (plus values for normal-phase feedback, minus values for reverse-phase feedback)
HI. RATIO	0.1–1.0	High-frequency feedback ratio
HPF	THRU, 21.2 Hz–8.00 kHz	High-pass filter cutoff frequency
LPF	50.0 Hz–16.0 kHz, THRU	Low-pass filter cutoff frequency
SYNC	OFF/ON	Tempo parameter sync on/off
NOTE L	*1	Used in conjunction with TEMPO to determine left channel DELAY
NOTE R	*1	Used in conjunction with TEMPO to determine right channel DELAY
NOTE FBL	*1	Used in conjunction with TEMPO to determine left channel feedback DELAY
NOTE FBR	*1	Used in conjunction with TEMPO to determine right channel feedback DELAY

\*1.  (Maximum value depends on the tempo setting)

## CHORUS

Two input, two output chorus effect.

Parameter	Range	Description
FREQ.	0.05–40.00 Hz	Modulation speed
AM DEPTH	0–100%	Amplitude modulation depth
PM DEPTH	0–100%	Pitch modulation depth
MOD. DLY	0.0–500.0 ms	Modulation delay time
WAVE	Sine, Tri	Modulation waveform
SYNC	OFF/ON	Tempo parameter sync on/off
NOTE	*1	Used in conjunction with TEMPO to determine FREQ
LSH F	21.2 Hz–8.00 kHz	Low shelving filter frequency
LSH G	–12.0 to +12.0 dB	Low shelving filter gain
EQ F	100 Hz–8.00 kHz	EQ (peaking type) frequency
EQ G	–12.0 to +12.0 dB	EQ (peaking type) gain
EQ Q	10.0–0.10	EQ (peaking type) bandwidth
HSH F	50.0 Hz–16.0 kHz	High shelving filter frequency
HSH G	–12.0 to +12.0 dB	High shelving filter gain

\*1. 

## ■ FLANGE

Two input, two output flange effect.

Parameter	Range	Description
FREQ.	0.05–40.00 Hz	Modulation speed
DEPTH	0–100%	Modulation depth
MOD. DLY	0.0–500.0 ms	Modulation delay time
FB. GAIN	–99 to +99%	Feedback gain (plus values for normal-phase feedback, minus values for reverse-phase feedback)
WAVE	Sine, Tri	Modulation waveform
SYNC	OFF/ON	Tempo parameter sync on/off
NOTE	*1	Used in conjunction with TEMPO to determine FREQ
LSH F	21.2 Hz–8.00 kHz	Low shelving filter frequency
LSH G	–12.0 to +12.0 dB	Low shelving filter gain
EQ F	100 Hz–8.00 kHz	EQ (peaking type) frequency
EQ G	–12.0 to +12.0 dB	EQ (peaking type) gain
EQ Q	10.0–0.10	EQ (peaking type) bandwidth
HSH F	50.0 Hz–16.0 kHz	High shelving filter frequency
HSH G	–12.0 to +12.0 dB	High shelving filter gain

\*1.

## ■ SYMPHONIC

Two input, two output symphonic effect.

Parameter	Range	Description
FREQ.	0.05–40.00 Hz	Modulation speed
DEPTH	0–100%	Modulation depth
MOD. DLY	0.0–500.0 ms	Modulation delay time
WAVE	Sine, Tri	Modulation waveform
SYNC	OFF/ON	Tempo parameter sync on/off
NOTE	*1	Used in conjunction with TEMPO to determine FREQ
LSH F	21.2 Hz–8.00 kHz	Low shelving filter frequency
LSH G	–12.0 to +12.0 dB	Low shelving filter gain
EQ F	100 Hz–8.00 kHz	EQ (peaking type) frequency
EQ G	–12.0 to +12.0 dB	EQ (peaking type) gain
EQ Q	10.0–0.10	EQ (peaking type) bandwidth
HSH F	50.0 Hz–16.0 kHz	High shelving filter frequency
HSH G	–12.0 to +12.0 dB	High shelving filter gain

\*1.

## ■ PHASER

Two input, two output 16-stage phaser.

Parameter	Range	Description
FREQ.	0.05–40.00 Hz	Modulation speed
DEPTH	0–100%	Modulation depth
FB. GAIN	–99 to +99%	Feedback gain (plus values for normal-phase feedback, minus values for reverse-phase feedback)
OFFSET	0–100	Lowest phase-shifted frequency offset
PHASE	0.00–354.38 degrees	Left and right modulation phase balance
STAGE	2, 4, 6, 8, 10, 12, 14, 16	Number of phase shift stages
SYNC	OFF/ON	Tempo parameter sync on/off
NOTE	*1	Used in conjunction with TEMPO to determine FREQ
LSH F	21.2 Hz–8.00 kHz	Low shelving filter frequency
LSH G	–12.0 to +12.0 dB	Low shelving filter gain
HSH F	50.0 Hz–16.0 kHz	High shelving filter frequency
HSH G	–12.0 to +12.0 dB	High shelving filter gain

\*1.

## ■ DYNA.FLANGE

Two input, two output dynamically controlled flanger.

Parameter	Range	Description
SOURCE	INPUT, MIDI	Control source: input signal or MIDI Note On velocity
SENSE	0–100	Sensitivity
DIR.	UP, DOWN	Upward or downward frequency change
DECAY	*1	Decay speed
OFFSET	0–100	Delay time offset
FB.GAIN	–99 to +99%	Feedback gain (plus values for normal-phase feedback, minus values for reverse-phase feedback)
LSH F	21.2 Hz–8.00 kHz	Low shelving filter frequency
LSH G	–12.0 to +12.0 dB	Low shelving filter gain
EQ F	100 Hz–8.00 kHz	EQ (peaking type) frequency
EQ G	–12.0 to +12.0 dB	EQ (peaking type) gain
EQ Q	10.0–0.10	EQ (peaking type) bandwidth
HSH F	50.0 Hz–16.0 kHz	High shelving filter frequency
HSH G	–12.0 to +12.0 dB	High shelving filter gain

\*1. 6.0 ms–46.0 s (fs=44.1 kHz), 5.0 ms–42.3 s (fs=48 kHz)

## ■ DYNA.PHASER

Two input, two output dynamically controlled phaser.

Parameter	Range	Description
SOURCE	INPUT, MIDI	Control source: input signal or MIDI Note On velocity
SENSE	0–100	Sensitivity
DIR.	UP, DOWN	Upward or downward frequency change
DECAY	*1	Decay speed
OFFSET	0–100	Lowest phase-shifted frequency offset
FB.GAIN	–99 to +99%	Feedback gain (plus values for normal-phase feedback, minus values for reverse-phase feedback)
STAGE	2, 4, 6, 8, 10, 12, 14, 16	Number of phase shift stages
LSH F	21.2 Hz–8.00 kHz	Low shelving filter frequency
LSH G	–12.0 to +12.0 dB	Low shelving filter gain
HSH F	50.0 Hz–16.0 kHz	High shelving filter frequency
HSH G	–12.0 to +12.0 dB	High shelving filter gain

\*1. 6.0 ms–46.0 s (fs=44.1 kHz), 5.0 ms–42.3 s (fs=48 kHz)

## ■ HQ.PITCH

One input, two output high-quality pitch shifter.

Parameter	Range	Description
PITCH	–12 to +12 semitones	Pitch shift
FINE	–50 to +50 cents	Pitch shift fine
DELAY	0.0–1000.0 ms	Delay time
FB. GAIN	–99 to +99%	Feedback gain (plus values for normal-phase feedback, minus values for reverse-phase feedback)
MODE	1–10	Pitch shift precision
SYNC	OFF/ON	Tempo parameter sync on/off
NOTE	*1	Used in conjunction with TEMPO to determine DELAY

\*1.  (Maximum value depends on the tempo setting)

## ■ DUAL PITCH

Two input, two output pitch shifter.

Parameter	Range	Description
PITCH 1	–24 to +24 semitones	Channel #1 pitch shift
FINE 1	–50 to +50 cents	Channel #1 pitch shift fine
LEVEL 1	–100 to +100%	Channel #1 level (plus values for normal phase, minus values for reverse phase)
PAN 1	L63 to R63	Channel #1 pan
DELAY 1	0.0–1000.0 ms	Channel #1 delay time
FB. G 1	–99 to +99%	Channel #1 feedback gain (plus values for normal-phase feedback, minus values for reverse-phase feedback)
MODE	1–10	Pitch shift precision
PITCH 2	–24 to +24 semitones	Channel #2 pitch shift
FINE 2	–50 to +50 cents	Channel #2 pitch shift fine
LEVEL 2	–100 to +100%	Channel #2 level (plus values for normal phase, minus values for reverse phase)
PAN 2	L63 to R63	Channel #2 pan
DELAY 2	0.0–1000.0 ms	Channel #2 delay time
FB. G 2	–99 to +99%	Channel #2 feedback gain (plus values for normal-phase feedback, minus values for reverse-phase feedback)
SYNC	OFF/ON	Tempo parameter sync on/off
NOTE 1	*1	Used in conjunction with TEMPO to determine Channel #1 delay
NOTE 2	*1	Used in conjunction with TEMPO to determine Channel #2 delay

\*1.  (Maximum value depends on the tempo setting)

## ■ TREMOLO

Two input, two output tremolo effect.

Parameter	Range	Description
FREQ.	0.05–40.00 Hz	Modulation speed
DEPTH	0–100%	Modulation depth
WAVE	Sine, Tri, Square	Modulation waveform
SYNC	OFF/ON	Tempo parameter sync on/off
NOTE	*1	Used in conjunction with TEMPO to determine FREQ
LSH F	21.2 Hz–8.00 kHz	Low shelving filter frequency
LSH G	–12.0 to +12.0 dB	Low shelving filter gain
EQ F	100 Hz–8.00 kHz	EQ (peaking type) frequency
EQ G	–12.0 to +12.0 dB	EQ (peaking type) gain
EQ Q	10.0–0.10	EQ (peaking type) bandwidth
HSH F	50.0 Hz–16.0 kHz	High shelving filter frequency
HSH G	–12.0 to +12.0 dB	High shelving filter gain

\*1.  (Maximum value depends on the tempo setting)

## AUTOPAN

Two input, two output autopanner.

Parameter	Range	Description
FREQ.	0.05–40.00 Hz	Modulation speed
DEPTH	0–100%	Modulation depth
DIR.	*1	Panning direction
WAVE	Sine, Tri, Square	Modulation waveform
SYNC	OFF/ON	Tempo parameter sync on/off
NOTE	*2	Used in conjunction with TEMPO to determine FREQ
LSH F	21.2 Hz–8.00 kHz	Low shelving filter frequency
LSH G	–12.0 to +12.0 dB	Low shelving filter gain
EQ F	100 Hz–8.00 kHz	EQ (peaking type) frequency
EQ G	–12.0 to +12.0 dB	EQ (peaking type) gain
EQ Q	10.0–0.10	EQ (peaking type) bandwidth
HSH F	50.0 Hz–16.0 kHz	High shelving filter frequency
HSH G	–12.0 to +12.0 dB	High shelving filter gain

\*1. L↔R, L→R, L←R, Turn L, Turn R

\*2.

## ROTARY

One input, two output rotary speaker simulator.

Parameter	Range	Description
ROTATE	STOP, START	Rotation stop, start
SPEED	SLOW, FAST	Rotation speed (see SLOW and FAST parameters)
SLOW	0.05–10.00 Hz	SLOW rotation speed
FAST	0.05–10.00 Hz	FAST rotation speed
DRIVE	0–100	Overdrive level
ACCEL	0–10	Acceleration at speed changes
LOW	0–100	Low-frequency filter
HIGH	0–100	High-frequency filter

## RING MOD.

Two input, two output ring modulator.

Parameter	Range	Description
SOURCE	OSC, SELF	Modulation source: oscillator or input signal
OSC FREQ	0.0–5000.0 Hz	Oscillator frequency
FM FREQ.	0.05–40.00 Hz	Oscillator frequency modulation speed
FM DEPTH	0–100%	Oscillator frequency modulation depth
SYNC	OFF/ON	Tempo parameter sync on/off
FM NOTE	*1	Used in conjunction with TEMPO to determine FM FREQ

\*1.

## MOD.FILTER

Two input, two output modulation filter.

Parameter	Range	Description
FREQ.	0.05–40.00 Hz	Modulation speed
DEPTH	0–100%	Modulation depth
PHASE	0.00–354.38 degrees	Left-channel modulation and right-channel modulation phase difference
TYPE	LPF, HPF, BPF	Filter type: low pass, high pass, band pass
OFFSET	0–100	Filter frequency offset
RESO.	0–20	Filter resonance
LEVEL	0–100	Output level
SYNC	OFF/ON	Tempo parameter sync on/off
NOTE	*1	Used in conjunction with TEMPO to determine FREQ

\*1.

## DYNA.FILTER

Two input, two output dynamically controlled filter.

Parameter	Range	Description
SOURCE	INPUT, MIDI	Control source: input signal or MIDI Note On velocity
SENSE	0–100	Sensitivity
DIR.	UP, DOWN	Upward or downward frequency change
DECAY	*1	Filter frequency change decay speed
TYPE	LPF, HPF, BPF	Filter type: low pass, high pass, band pass
OFFSET	0–100	Filter frequency offset
RESO.	0–20	Filter resonance
LEVEL	0–100	Output level

\*1. 6.0 ms–46.0 s (fs=44.1 kHz), 5.0 ms–42.3 s (fs=48 kHz)



## ■ REV+CHORUS

One input, two output reverb and chorus effects in parallel.

Parameter	Range	Description
REV TIME	0.3–99.0 s	Reverb time
INI. DLY	0.0–500.0 ms	Initial delay before reverb begins
HI. RATIO	0.1–1.0	High-frequency reverb time ratio
DIFF.	0–10	Spread
DENSITY	0–100%	Reverb density
REV/CHO	0–100%	Reverb and chorus balance (0% = all reverb, 100% = all chorus)
HPF	THRU, 21.2 Hz–8.00 kHz	High-pass filter cutoff frequency
LPF	50.0 Hz–16.0 kHz, THRU	Low-pass filter cutoff frequency
FREQ.	0.05–40.00 Hz	Modulation speed
AM DEPTH	0–100%	Amplitude modulation depth
PM DEPTH	0–100%	Pitch modulation depth
MOD. DLY	0.0–500.0 ms	Modulation delay time
WAVE	Sine, Tri	Modulation waveform
SYNC	OFF/ON	Tempo parameter sync on/off
NOTE	*1	Used in conjunction with TEMPO to determine FREQ

\*1. 

## ■ REV→CHORUS

One input, two output reverb and chorus effects in series.

Parameter	Range	Description
REV TIME	0.3–99.0 s	Reverb time
INI. DLY	0.0–500.0 ms	Initial delay before reverb begins
HI. RATIO	0.1–1.0	High-frequency reverb time ratio
DIFF.	0–10	Spread
DENSITY	0–100%	Reverb density
REV.BAL	0–100%	Reverb and chorused reverb balance (0% = all chorused reverb, 100% = all reverb)
HPF	THRU, 21.2 Hz–8.00 kHz	High-pass filter cutoff frequency
LPF	50.0 Hz–16.0 kHz, THRU	Low-pass filter cutoff frequency
FREQ.	0.05–40.00 Hz	Modulation speed
AM DEPTH	0–100%	Amplitude modulation depth
PM DEPTH	0–100%	Pitch modulation depth
MOD. DLY	0.0–500.0 ms	Modulation delay time
WAVE	Sine, Tri	Modulation waveform
SYNC	OFF/ON	Tempo parameter sync on/off
NOTE	*1	Used in conjunction with TEMPO to determine FREQ

\*1. 

## ■ REV+FLANGE

One input, two output reverb and flanger effects in parallel.

Parameter	Range	Description
REV TIME	0.3–99.0 s	Reverb time
INI. DLY	0.0–500.0 ms	Initial delay before reverb begins
HI. RATIO	0.1–1.0	High-frequency reverb time ratio
DIFF.	0–10	Spread
DENSITY	0–100%	Reverb density
REV/FLG	0–100%	Reverb and flange balance (0% = all reverb, 100% = all flange)
HPF	THRU, 21.2 Hz–8.00 kHz	High-pass filter cutoff frequency
LPF	50.0 Hz–16.0 kHz, THRU	Low-pass filter cutoff frequency
FREQ.	0.05–40.00 Hz	Modulation speed
DEPTH	0–100%	Modulation depth
MOD. DLY	0.0–500.0 ms	Modulation delay time
FB. GAIN	–99 to +99%	Feedback gain (plus values for normal-phase feedback, minus values for reverse-phase feedback)
WAVE	Sine, Tri	Modulation waveform
SYNC	OFF/ON	Tempo parameter sync on/off
NOTE	*1	Used in conjunction with TEMPO to determine FREQ

\*1. 

## ■ REV→FLANGE

One input, two output reverb and flanger effects in series.

Parameter	Range	Description
REV TIME	0.3–99.0 s	Reverb time
INI. DLY	0.0–500.0 ms	Initial delay before reverb begins
HI. RATIO	0.1–1.0	High-frequency reverb time ratio
DIFF.	0–10	Spread
DENSITY	0–100%	Reverb density
REV.BAL	0–100%	Reverb and flanged reverb balance (0% = all flanged reverb, 100% = all reverb)
HPF	THRU, 21.2 Hz–8.00 kHz	High-pass filter cutoff frequency
LPF	50.0 Hz–16.0 kHz, THRU	Low-pass filter cutoff frequency
FREQ.	0.05–40.00 Hz	Modulation speed
DEPTH	0–100%	Modulation depth
MOD. DLY	0.0–500.0 ms	Modulation delay time
FB. GAIN	–99 to +99%	Feedback gain (plus values for normal-phase feedback, minus values for reverse-phase feedback)
WAVE	Sine, Tri	Modulation waveform
SYNC	OFF/ON	Tempo parameter sync on/off
NOTE	*1	Used in conjunction with TEMPO to determine FREQ

\*1. 

## ■ REV+SYMPHO.

One input, two output reverb and symphonic effects in parallel.

Parameter	Range	Description
REV TIME	0.3–99.0 s	Reverb time
INI. DLY	0.0–500.0 ms	Initial delay before reverb begins
HI. RATIO	0.1–1.0	High-frequency reverb time ratio
DIFF.	0–10	Spread
DENSITY	0–100%	Reverb density
REV/SYM	0–100%	Reverb and symphonic balance (0% = all reverb, 100% = all symphonic)
HPF	THRU, 21.2 Hz–8.00 kHz	High-pass filter cutoff frequency
LPF	50.0 Hz–16.0 kHz, THRU	Low-pass filter cutoff frequency
FREQ.	0.05–40.00 Hz	Modulation speed
DEPTH	0–100%	Modulation depth
MOD. DLY	0.0–500.0 ms	Modulation delay time
WAVE	Sine, Tri	Modulation waveform
SYNC	OFF/ON	Tempo parameter sync on/off
NOTE	*1	Used in conjunction with TEMPO to determine FREQ

\*1. 

## ■ REV→SYMPHO.

One input, two output reverb and symphonic effects in series.

Parameter	Range	Description
REV TIME	0.3–99.0 s	Reverb time
INI. DLY	0.0–500.0 ms	Initial delay before reverb begins
HI. RATIO	0.1–1.0	High-frequency reverb time ratio
DIFF.	0–10	Spread
DENSITY	0–100%	Reverb density
REV.BAL	0–100%	Reverb and symphonic reverb balance (0% = all symphonic reverb, 100% = all reverb)
HPF	THRU, 21.2 Hz–8.00 kHz	High-pass filter cutoff frequency
LPF	50.0 Hz–16.0 kHz, THRU	Low-pass filter cutoff frequency
FREQ.	0.05–40.00 Hz	Modulation speed
DEPTH	0–100%	Modulation depth
MOD. DLY	0.0–500.0 ms	Modulation delay time
WAVE	Sine, Tri	Modulation waveform
SYNC	OFF/ON	Tempo parameter sync on/off
NOTE	*1	Used in conjunction with TEMPO to determine FREQ

\*1. 

## ■ REV→PAN

This is a 1-in/2-out series-connected reverb and auto-pan effect.

Parameter	Range	Description
REV TIME	0.3–99.0 s	Reverb time
INI. DLY	0.0–500.0 ms	Initial delay before reverb begins
HI. RATIO	0.1–1.0	High-frequency reverb time ratio
DIFF.	0–10	Spread
DENSITY	0–100%	Reverb density
REV.BAL	0–100%	Reverb and panned reverb balance (0% = all panned reverb, 100% = all reverb)
HPF	THRU, 21.2 Hz–8.00 kHz	High-pass filter cutoff frequency
LPF	50.0 Hz–16.0 kHz, THRU	Low-pass filter cutoff frequency
FREQ.	0.05–40.00 Hz	Modulation speed
DEPTH	0–100%	Modulation depth
DIR.	*1	Panning direction
WAVE	Sine, Tri, Square	Modulation waveform
SYNC	OFF/ON	Tempo parameter sync on/off
NOTE	*2	Used in conjunction with TEMPO to determine FREQ

\*1. L↔R, L→R, L←R, Turn L, Turn R

\*2. 

## ■ DELAY+ER.

One input, two output delay and early reflections effects in parallel.

Parameter	Range	Description
DELAY L	0.0–1000.0 ms	Left channel delay time
DELAY R	0.0–1000.0 ms	Right channel delay time
FB. DLY	0.0–1000.0 ms	Feedback delay time
FB. GAIN	–99 to +99%	Feedback gain (plus values for normal-phase feedback, minus values for reverse-phase feedback)
HI. RATIO	0.1–1.0	High-frequency feedback ratio
DLY/ER	0–100%	Delay and early reflections balance (0% = all delay, 100% = all early reflections)
HPF	THRU, 21.2 Hz–8.00 kHz	High-pass filter cutoff frequency
LPF	50.0 Hz–16.0 kHz, THRU	Low-pass filter cutoff frequency
TYPE	S-Hall, L-Hall, Random, Revers, Plate, Spring	Type of early reflection simulation
ROOMSIZE	0.1–20.0	Reflection spacing
LIVENESS	0–10	Early reflections decay characteristics (0 = dead, 10 = live)
INI. DLY	0.0–500.0 ms	Initial delay before reverb begins
DIFF.	0–10	Spread
DENSITY	0–100%	Reflection density
ER NUM.	1–19	Number of early reflections
SYNC	OFF/ON	Tempo parameter sync on/off
NOTE L	*1	Used in conjunction with TEMPO to determine left channel DELAY
NOTE R	*1	Used in conjunction with TEMPO to determine right channel DELAY
NOTE FB	*1	Used in conjunction with TEMPO to determine feedback DELAY

\*1.  (Maximum value depends on the tempo setting)

## ■ DELAY → ER.

One input, two output delay and early reflections effects in series.

Parameter	Range	Description
DELAY L	0.0–1000.0 ms	Left channel delay time
DELAY R	0.0–1000.0 ms	Right channel delay time
FB. DLY	0.0–1000.0 ms	Feedback delay time
FB. GAIN	–99 to +99%	Feedback gain (plus values for normal-phase feedback, minus values for reverse-phase feedback)
HI. RATIO	0.1–1.0	High-frequency feedback ratio
DLY.BAL	0–100%	Delay and early reflected delay balance (0% = all early reflected delay, 100% = all delay)
HPF	THRU, 21.2 Hz–8.00 kHz	High-pass filter cutoff frequency
LPF	50.0 Hz–16.0 kHz, THRU	Low-pass filter cutoff frequency
TYPE	S-Hall, L-Hall, Random, Revers, Plate, Spring	Type of early reflection simulation
ROOMSIZE	0.1–20.0	Reflection spacing
LIVENESS	0–10	Early reflections decay characteristics (0 = dead, 10 = live)
INI. DLY	0.0–500.0 ms	Initial delay before reverb begins
DIFF.	0–10	Spread
DENSITY	0–100%	Reflection density
ER NUM.	1–19	Number of early reflections
SYNC	OFF/ON	Tempo parameter sync on/off
NOTE L	*1	Used in conjunction with TEMPO to determine left channel DELAY
NOTE R	*1	Used in conjunction with TEMPO to determine right channel DELAY
NOTE FB	*1	Used in conjunction with TEMPO to determine feedback DELAY

\*1. —  (Maximum value depends on the tempo setting)

## ■ DELAY + REV

One input, two output delay and reverb effects in parallel.

Parameter	Range	Description
DELAY L	0.0–1000.0 ms	Left channel delay time
DELAY R	0.0–1000.0 ms	Right channel delay time
FB. DLY	0.0–1000.0 ms	Feedback delay time
FB. GAIN	–99 to +99%	Feedback gain (plus values for normal-phase feedback, minus values for reverse-phase feedback)
DELAY HI	0.1–1.0	Delay high-frequency feedback ratio
DLY/REV	0–100%	Delay and reverb balance (0% = all delay, 100% = all reverb)
HPF	THRU, 21.2 Hz–8.00 kHz	High-pass filter cutoff frequency
LPF	50.0 Hz–16.0 kHz, THRU	Low-pass filter cutoff frequency
REV TIME	0.3–99.0 s	Reverb time
INI. DLY	0.0–500.0 ms	Initial delay before reverb begins
REV HI	0.1–1.0	High-frequency reverb time ratio
DIFF.	0–10	Spread
DENSITY	0–100%	Reverb density

Parameter	Range	Description
SYNC	OFF/ON	Tempo parameter sync on/off
NOTE L	*1	Used in conjunction with TEMPO to determine left channel DELAY
NOTE R	*1	Used in conjunction with TEMPO to determine right channel DELAY
NOTE FB	*1	Used in conjunction with TEMPO to determine feedback DELAY

\*1. —  (Maximum value depends on the tempo setting)

## ■ DELAY → REV

One input, two output delay and reverb effects in series.

Parameter	Range	Description
DELAY L	0.0–1000.0 ms	Left channel delay time
DELAY R	0.0–1000.0 ms	Right channel delay time
FB. DLY	0.0–1000.0 ms	Feedback delay time
FB. GAIN	–99 to +99%	Feedback gain (plus values for normal-phase feedback, minus values for reverse-phase feedback)
DELAY HI	0.1–1.0	Delay high-frequency feedback ratio
DLY.BAL	0–100%	Delay and delayed reverb balance (0% = all delayed reverb, 100% = all delay)
HPF	THRU, 21.2 Hz–8.00 kHz	High-pass filter cutoff frequency
LPF	50.0 Hz–16.0 kHz, THRU	Low-pass filter cutoff frequency
REV TIME	0.3–99.0 s	Reverb time
INI. DLY	0.0–500.0 ms	Initial delay before reverb begins
REV HI	0.1–1.0	High-frequency reverb time ratio
DIFF.	0–10	Spread
DENSITY	0–100%	Reverb density
SYNC	OFF/ON	Tempo parameter sync on/off
NOTE L	*1	Used in conjunction with TEMPO to determine left channel DELAY
NOTE R	*1	Used in conjunction with TEMPO to determine right channel DELAY
NOTE FB	*1	Used in conjunction with TEMPO to determine feedback DELAY

\*1. —  (Maximum value depends on the tempo setting)

## ■ DIST→DELAY

One input, two output distortion and delay effects in series.

Parameter	Range	Description
DST TYPE	DST1, DST2, OVD1, OVD2, CRUNCH	Distortion type (DST = distortion, OVD = overdrive)
DRIVE	0–100	Distortion drive
MASTER	0–100	Master volume
TONE	–10 to +10	Tone control
N. GATE	0–20	Noise reduction
SYNC	OFF/ON	Tempo parameter sync on/off
DLY.NOTE	*1	Used in conjunction with TEMPO to determine DELAY
MOD.NOTE	*2	Used in conjunction with TEMPO to determine FREQ
DELAY	0.0–2725.0 ms	Delay time
FB. GAIN	–99 to +99%	Feedback gain (plus values for normal-phase feedback, minus values for reverse-phase feedback)
HI. RATIO	0.1–1.0	High-frequency feedback ratio
FREQ.	0.05–40.00 Hz	Modulation speed
DEPTH	0–100%	Modulation depth
DLY.BAL	0–100%	Distortion and delay balance (0% = all distortion, 100% = all delayed distortion)

\*1.  (Maximum value depends on the tempo setting)

\*2. 

## ■ MULTI FILTER

Two input, two output 3-band multi-filter (24 dB/octave).

Parameter	Range	Description
TYPE 1	LPF, HPF, BPF	Filter 1 type: high pass, low pass, band pass
FREQ. 1	28.0 Hz–16.0 kHz	Filter 1 frequency
LEVEL 1	0–100	Filter 1 level
RESO. 1	0–20	Filter 1 resonance
TYPE 2	LPF, HPF, BPF	Filter 2 type: high pass, low pass, band pass
FREQ. 2	28.0 Hz–16.0 kHz	Filter 2 frequency
LEVEL 2	0–100	Filter 2 level
RESO. 2	0–20	Filter 2 resonance
TYPE 3	LPF, HPF, BPF	Filter 3 type: high pass, low pass, band pass
FREQ. 3	28.0 Hz–16.0 kHz	Filter 3 frequency
LEVEL 3	0–100	Filter 3 level
RESO. 3	0–20	Filter 3 resonance

## ■ FREEZE

One input, two output basic sampler.

Parameter	Range	Description
REC MODE	MANUAL, INPUT	In MANUAL mode, recording is started by pressing the REC and PLAY buttons. In INPUT mode, Record-Ready mode is engaged by pressing the REC button, and actual recording is triggered by the input signal.
REC DLY	–1000 to +1000 ms	Recording delay. For plus values, recording starts after the trigger is received. For minus values, recording starts before the trigger is received.
PLY MODE	MOMENT, CONTI., INPUT	In MOMENT mode, the sample plays only while the PLAY button is pressed. In CONT mode, playback continues once the PLAY button has been pressed. The number of times the sample plays is set using the LOOP NUM parameter. In INPUT mode, playback is triggered by the input signal.
TRG LVL	–60 to 0 dB	Input trigger level (i.e., the signal level required to trigger recording or playback)
TRG MASK	0–1000 ms	Once playback has been triggered, subsequent triggers are ignored for the duration of the TRG MASK time.
START	*1	Playback start point in milliseconds
END	*1	Playback end point in milliseconds
LOOP	*1	Loop start point in milliseconds
LOOP NUM	0–100	Number of times the sample plays
PITCH	–12 to +12 semitones	Playback pitch shift
FINE	–50 to +50 cents	Playback pitch shift fine
MIDI TRG	OFF, C1–C6, ALL	The PLAY button can be triggered by using MIDI Note on/off messages.
START [SAMPLE]	0–131000	Playback start point in samples
END [SAMPLE]	0–131000	Playback end point in samples
LOOP [SAMPLE]	0–131000	Loop start point in samples

\*1. 0.0–5941.0 ms (fs=44.1 kHz), 0.0 ms–5458.3 ms (fs=48 kHz)

## ■ DISTORTION

One input, two output distortion effect.

Parameter	Range	Description
DST TYPE	DST1, DST2, OVD1, OVD2, CRUNCH	Distortion type (DST = distortion, OVD = overdrive)
DRIVE	0–100	Distortion drive
MASTER	0–100	Master volume
TONE	–10 to +10	Tone control
N. GATE	0–20	Noise reduction

## ■ AMP SIMULATE

One input, two output guitar amp simulator.

Parameter	Range	Description
AMP TYPE	*1	Guitar amp simulation type
DST TYPE	DST1, DST2, OVD1, OVD2, CRUNCH	Distortion type (DST = distortion, OVD = overdrive)
DRIVE	0-100	Distortion drive
MASTER	0-100	Master volume
BASS	0-100	Bass tone control
MIDDLE	0-100	Middle tone control
TREBLE	0-100	High tone control
N. GATE	0-20	Noise reduction
CAB DEP	0-100%	Speaker cabinet simulation depth
EQ F	100 Hz-8.00 kHz	EQ (peaking type) frequency
EQ G	-12.0 to +12.0 dB	EQ (peaking type) gain
EQ Q	10.0-0.10	EQ (peaking type) bandwidth

\*1. STK-M1, STK-M2, THRASH, MIDBST, CMB-PG, CMB-VR, CMB-DX, CMB-TW, MINI, FLAT

## ■ COMP276

This effect emulates the characteristics of analog compressors that are widely used in recording studios. It produces a thick, strong frame sound suitable for drums and bass. You can control two monaural channels independently.

Parameter	Range	Description
INPUT 1	-180 to 0 dB	Adjusts the CH1 input level
OUTPUT 1	-180 to 0 dB	Adjusts the CH1 output gain
RATIO 1	2:1, 4:1, 8:1, 12:1, 20:1	Ratio for CH1 compressor
ATTACK 1	0.022-50.4 ms	Attack time of CH1 compressor
RELEASE1	10.88-544.22 ms	Release time of CH1 compressor
MAKE UP1	OFF, ON	Automatically corrects output gain reduction when CH1 compressor is applied
SIDEHPF1	OFF, ON	When the HPF in the side chain of the CH1 compressor is turned on, the compression applied to the low range will be weakened, thus emphasizing the low range.
INPUT 2	-180 to 0 dB	Adjusts the CH2 input level
OUTPUT 2	-180 to 0 dB	Adjusts the CH2 output gain
RATIO 2	2:1, 4:1, 8:1, 12:1, 20:1	Ratio of CH2 compressor
ATTACK 2	0.022-50.4 ms	Attack time of CH2 compressor
RELEASE2	10.88-544.22 ms	Release time of CH2 compressor
MAKE UP2	OFF, ON	Automatically corrects output gain reduction when the CH2 compressor is applied
SIDEHPF2	OFF, ON	When the HPF in the side chain of the CH2 compressor is turned on, the compression applied to the low range will be weakened, thus emphasizing the low range.

## ■ COMP276S

This effect emulates the characteristics of analog compressors that are widely used in recording studios. It produces a thick, strong frame sound suitable for drums and bass. You can link and control the L and R channel parameters.

Parameter	Range	Description
INPUT	-180 to 0 dB	Adjusts the input level
OUTPUT	-180 to 0 dB	Adjusts the output gain
RATIO	2:1, 4:1, 8:1, 12:1, 20:1	Ratio of the compressor
ATTACK	0.022-50.4 ms	Attack time of the compressor
RELEASE	10.88-544.22 ms	Release time of the compressor
MAKE UP	OFF, ON	Automatically corrects output gain reduction when the compressor is applied
SIDE HPF	OFF, ON	When the HPF in the side chain of the compressor is turned on, the compression applied to the low range will be weakened, thus emphasizing the low range.

## ■ COMP260

This effect emulates the characteristics of mid 70's compressors/limiters that are the standard for live SR. You can control two monaural channels independently. You can also link several parameters via stereo links.

Parameter	Range	Description
THRE.1	-60 to 0.0 dB	Threshold of CH compressor
KNEE1	SOFT, MEDIUM, HARD	Knee of CH1 compressor
ATTACK1	0.01-80.0 ms	Attack time of CH1 compressor
RELEASE1	6.2-999 ms	Release time of CH1 compressor
RATIO1	1.0-500, ∞	Ratio for CH1 compressor
OUTPUT1	-20 to 40 dB	Adjusts the CH1 output gain
THRE.2	-60 to 0.0 dB	Threshold of CH2 compressor
KNEE2	SOFT, MEDIUM, HARD	Knee of CH2 compressor
ATTACK2	0.01-80.0 ms	Attack time of CH2 compressor
RELEASE2	6.2-999 ms	Release time of CH2 compressor
RATIO2	1.0-500, ∞	Ratio of CH2 compressor
OUTPUT2	-20 to 40 dB	Adjusts the CH2 output gain
ST LINK	OFF, ON	Links CH1 and CH2 as a stereo pair. THRE., KNEE, ATTACK, RELEASE, and RATIO parameters are linked; OUTPUT parameter is not linked

## ■ COMP260S

This effect emulates the characteristics of mid 70's compressors/limiters that are the standard for live SR. You can link and control the L and R channel parameters.

Parameter	Range	Description
THRE.	-60 to 0.0 dB	Threshold of the compressor
KNEE	SOFT, MEDIUM, HARD	Knee of the compressor
ATTACK	0.01-80.0 ms	Attack time of the compressor
RELEASE	6.2-999 ms	Release time of the compressor
RATIO	1.0-500, ∞	Ratio of the compressor
OUTPUT	-20 to 40 dB	Adjusts the output gain

## ■ EQUALIZER601

This effect emulates the characteristics of 70's analog equalizers. Re-creating the distortion of typical analog circuits will add drive to the sound.

Parameter	Range	Description
LO TYPE	HPF-2/1, LSH-1/2	Type of EQ1
LO F	16.0 Hz to 20.0 kHz	Cut-off frequency of EQ1
LO G	-18.0 to +18.0 dB	Gain of EQ1
MID1 Q	0.50-16.0	Q of EQ2
MID1 F	16.0 Hz to 20.0 kHz	Center frequency of EQ2
MID1 G	-18.0 to +18.0 dB	Gain of EQ2
MID2 Q	0.50-16.0	Q of EQ3
MID2 F	16.0 Hz to 20.0 kHz	Center frequency of EQ3
MID2 G	-18.0 to +18.0 dB	Gain of EQ3
INPUT	-18.0 to +18.0 dB	Input gain
OUTPUT	-18.0 to +18.0 dB	Output gain
MID3 Q	0.50-16.0	Q of EQ4
MID3 F	16.0 Hz to 20.0 kHz	Center frequency of EQ4
MID3 G	-18.0 to +18.0 dB	Gain of EQ4
MID4 Q	0.50-16.0	Q of EQ5
MID4 F	16.0 Hz to 20.0 kHz	Center frequency of EQ5
MID4 G	-18.0 to +18.0 dB	Gain of EQ5
HI TYPE	LPF-2/1, HSH-1/2	Type of EQ6
HI F	16.0 Hz to 20.0 kHz *1	Cut-off frequency of EQ6
HI G	-18.0 to +18.0 dB	Gain of EQ6
LO SW	OFF, ON	Switches EQ1 on/off
MID1 SW	OFF, ON	Switches EQ2 on/off
MID2 SW	OFF, ON	Switches EQ3 on/off
MID3 SW	OFF, ON	Switches EQ4 on/off
MID4 SW	OFF, ON	Switches EQ5 on/off
HI SW	OFF, ON	Switches EQ6 on/off
TYPE	CLEAN, DRIVE	Selects the equalizer type. The CLEAN equalizer provides non-distorted, clear, typical digital sound, emulating variations in frequency response in the analog circuits. The DRIVE equalizer provides distorted, driven sound that enhances analog flavor, emulating changes in frequency response in the analog circuits.

\*1. 16.0 Hz to 20.0 kHz (LPF-1, LPF-2), 1.0 kHz to 20.0 kHz (HSH-1, HSH-2)

## ■ OPENDECK

It emulates the tape compression created by two open reel tape recorders (a recording deck and a playback deck). You can change the sound quality by adjusting various elements, such as the deck type, tape quality, playback speed, etc.

Parameter	Range	Description
REC DEC	Swss70, Swss78, Swss85, Amer70	Selects the recording deck type
REC LVL	-96.0 to +18.0 dB	Adjusts the input level of the recording deck. As you raise the level, tape compression is generated, which narrows the dynamic range and distorts the sound.
REC HI	-6.0 to +6.0 dB	Adjusts the high range gain of the recording deck
REC BIAS	-1.00 to +1.00	Adjusts the bias of the recording deck
REPR DEC	Swss70, Swss78, Swss85, Amer70	Selects the playback deck type
REPR LVL	-96.0 to +18.0 dB	Adjusts the output level of the playback deck
REPR HI	-6.0 to +6.0 dB	Adjusts the high range gain of the playback deck
REPR LO	-6.0 to +6.0 dB	Adjusts the low range gain of the playback deck
MAKE UP	Off, On	When you adjust the REC LVL, the REPR LVL reflects the change, maintaining the relative output level. You can change the amount of distortion without changing the output level.
TP SPEED	15ips, 30ips	Selects the tape speed
TP KIND	Old, New	Selects the tape type

## ■ M.BAND DYNA.

Two input, two output 3-band dynamics processor, with individual solo and gain reduction metering for each band.

Parameter	Range	Description
L-M XOVER	21.2 Hz-8.00 kHz	Crossover frequency between the low and mid bands
M-H XOVER	21.2 Hz-8.00 kHz	Crossover frequency between the mid and high bands
SLOPE	-6 dB, -12 dB	Filter slope
LOW GAIN	-12.0 dB to +12.0 dB	Low band gain
MID GAIN	-12.0 dB to +12.0 dB	Mid band gain
HI. GAIN	-12.0 dB to +12.0 dB	High band gain
TOTAL	-72.0 dB to +12.0 dB	Overall gain
CEILING	-6.0 dB to 0.0 dB, OFF	Restricts the output so that it will not exceed the specified level
CMP.THRE	-24.0 dB to 0.0 dB	Threshold of the compressor
CMP.RAT	1:1 to 20:1	Ratio of the compressor
CMP.ATK	0-120 ms	Attack time of the compressor
CMP.REL	*1	Release time of the compressor
CMP.KNEE	0-5	Knee of the compressor
CMP.BYP	OFF/ON	Bypasses the compressor
EXP.THRE	-54.0 dB to -24.0 dB	Threshold of the expander
EXP.RAT	1:1 to 5:1	Ratio of the expander
EXP.REL	*1	Release time of the expander
EXP.BYP	OFF/ON	Bypasses the expander
LIM.THRE	-12.0 dB to 0.0 dB	Threshold of the limiter

Parameter	Range	Description
LIM.ATK	0–120 ms	Attack time of the limiter
LIM.REL	*1	Release time of the limiter
LIM.KNEE	0–5	Knee of the limiter
LIM.BYP	OFF/ON	Bypasses the limiter
PRESENCE	–10 to +10	Positive (+) values lower the threshold of the high band and raise the threshold of the low band. Negative (–) values do the opposite. If this is set to 0, the high, mid, and low bands will be affected in the same way.
LOOKUP	0.0–100.0 ms	Lookup delay
MAKE UP	OFF/ON	Automatically adjusts the output level

\*1. 6.0 ms–46.0 s (fs=44.1 kHz), 5.0 ms–42.3 s (fs=48 kHz)

## ■ M.BAND COMP

Two input, two output 3-band compressor, with individual solo and gain reduction metering for each band.

Parameter	Range	Description
L-M XOVER	21.2 Hz–8.00 kHz	Crossover frequency between the low and mid bands
M-H XOVER	21.2 Hz–8.00 kHz	Crossover frequency between the mid and high bands
SLOPE	–6 dB, –12 dB	Filter slope
LOW GAIN	–12.0 dB to +12.0 dB	Low band gain
MID GAIN	–12.0 dB to +12.0 dB	Mid band gain
HI. GAIN	–12.0 dB to +12.0 dB	High band gain
TOTAL	–72.0 dB to +12.0 dB	Overall gain
CEILING	–6.0 dB to 0.0 dB, OFF	Restricts the output so that it will not exceed the specified level
LOW THRE	–54.0 dB to 0.0 dB	Threshold of the low band compressor
LOW RAT	1:1 to 20:1	Ratio of the low band compressor
LOW ATK	0–120 ms	Attack time of the low band compressor
LOW REL	*1	Release time of the low band compressor
LOW KNEE	0–5	Knee of the low band compressor
LOW BYP	OFF/ON	Bypasses the low band compressor
MID THRE	–54.0 dB to 0.0 dB	Threshold of the mid band compressor
MID RAT	1:1 to 20:1	Ratio of the mid band compressor
MID ATK	0–120 ms	Attack time of the mid band compressor
MID REL	*1	Release time of the mid band compressor
MID KNEE	0–5	Knee of the mid band compressor
MID BYP	OFF/ON	Bypasses the mid band compressor
HI. THRE	–54.0 dB to 0.0 dB	Threshold of the high band compressor
HI. RAT	1:1 to 20:1	Ratio of the high band compressor
HI. ATK	0–120 ms	Attack time of the high band compressor
HI. REL	*1	Release time of the high band compressor
HI. KNEE	0–5	Knee of the high band compressor
HI. BYP	OFF/ON	Bypasses the high band compressor
LOOKUP	0.0–100.0 ms	Lookup delay
MAKE UP	OFF/ON	Automatically adjusts the output level

\*1. 6.0 ms–46.0 s (fs=44.1 kHz), 5.0 ms–42.3 s (fs=48 kHz)

## Premium Rack Processor Parameters

### ■ Portico5033

This models an analog 5-band EQ made by the RND company.

Parameter	Range	Description
ALL BYPASS	OFF, ON	Turns bypass on/off for the EQ. Even in the bypassed state, the signal will pass through the input/output transformers and the amp circuit.
TRIM	–12.0 to 12.0 dB	Input gain
LF FREQ	30.00 to 300.0 Hz	Center frequency of the LF band
LF GAIN	–12.0 to 12.0 dB	Gain of the LF band
LMF IN	OFF, ON	Switches the LMF band on/off
LMF Q	0.70 to 5.00	Q of the LMF band
LMF FREQ	50.00 to 400.0 Hz	Center frequency of the LMF band
LMF GAIN	–12.0 to 12.0 dB	Gain of the LMF band
MF IN	OFF, ON	Switches the MF band on/off
MF Q	0.70 to 5.00	Q of the MF band
MF FREQ	330.0 to 2500 Hz	Center frequency of the MF band
MF GAIN	–12.0 to 12.0 dB	Gain of the MF band
HMF IN	OFF, ON	Switches the HMF band on/off
HMF Q	0.70 to 5.00	Q of the HMF band
HMF FREQ	1.80k to 16.0k Hz	Center frequency of the HMF band
HMF GAIN	–12.0 to 12.0 dB	Gain of the HMF band
LF/HF IN	OFF, ON	Switches the LF/HF bands on/off
HF FREQ	2.50k to 25.0k Hz	Center frequency of the HF band
HF GAIN	–12.0 to 12.0 dB	Gain of the HF band

### ■ Portico5043

This models an analog compressor/limiter made by the RND company.

Parameter	Range	Description
IN	OFF, ON	Turns bypass on/off for the compressor. When bypassed, the button will be unlit. However even in the bypassed state, the signal will pass through the input/output transformers and the amp circuit.
FB	OFF, ON	Switches between feed-forward type and feed-back type
THRESHOLD	–50.0 to 0.0 dB	Threshold level
RATIO	1.10 : 1 to 28.9 : 1, LIMIT	Compression ratio
ATTACK	20 to 75 ms	Attack time
RELEASE	100 ms to 2.50 sec	Release time
GAIN	–6.0 to 20.0 dB	Output level



## U76

This models a well-known vintage compressor/limiter used in a wide range of situations.

Parameter	Range	Description
INPUT	-96.0 to 0.0 dB	Input level
OUTPUT	-96.0 to 0.0 dB	Output level
ATTACK	5.50 to 0.10 ms	Attack time of the compressor. Turning this all the way to the right produces the fastest attack.
RELEASE	1100.0 to 56.4 ms	Release time of the compressor. Turning this all the way to the right produces the fastest release.
RATIO	ALL, 4, 8, 12, 20	Switches the compression ratio. Pressing ALL produces the strongest effect.
METER	OFF, +4, +8, GR	Switches the meter display

## Opt-2A

This processor emulates a well-known vintage model of vacuum tube opto compressor.

Parameter	Range	Description
GAIN	-56.0 dB to 40.0 dB	Output level
PEAK REDUCTION	-48.0 dB to 48.0 dB	Amount of gain reduction
RATIO	2.00 to 10.00	Compression ratio
METER SELECT	OUTPUT+10, GAIN REDUCTION, OUTPUT+4	Switches the meter display

## EQ-1A

This processor emulates a vintage EQ that's considered a classic example of a passive EQ.

Parameter	Range	Description
LOW FREQUENCY	20, 30, 60, 100 Hz	Frequency range of the low range filter
(LOW) BOOST	0.0 to 10.0	Boost amount of the low range filter
(LOW) ATTEN	0.0 to 10.0	Attenuation amount of the low range filter
HIGH FREQUENCY	3k, 4k, 5k, 8k, 10k, 12k, 16k Hz	Frequency range of the high range filter
(HIGH) BOOST	0.0 to 10.0	Boost amount of the high range filter
(HIGH) BAND WIDTH	0.0 to 10.0	Band width of the high range filter
(HIGH) ATTEN SEL	5k, 10k, 20k Hz	Frequency range attenuated by the high range filter
(HIGH) ATTEN	0.0 to 10.0	Attenuation amount of the high range filter
IN	OFF, ON	Turns the processor on/off. If this is off, the filter section will be bypassed, but the signal will pass through the input/output transformers and the amp circuit.

## Dynamic EQ

This is a newly developed equalizer that dynamically changes the EQ gain in response to the input signal, controlling the amount of EQ cut or boost in a way similar to a compressor or expander.

Parameter	Range	Description
BAND ON/OFF	OFF, ON	Turns the corresponding band on/off
SIDECHAIN CUE	OFF, ON	If this is on, the sidechain signal that controls the dynamics will be sent to the CUE bus for monitoring.
SIDECHAIN LISTEN	OFF, ON	If this is on, the sidechain signal that is linked to the dynamics will be output to the bus (such as the STEREO bus or a MIX/MATRIX bus) to which the inserted channel is being sent.
FILTER TYPE	Low Shelf, Bell, Hi Shelf	Switches the type of equalizer and sidechain filter
FREQUENCY	20.0 to 20.0k Hz	Frequency controlled by the equalizer and sidechain filter
Q	15.0 to 0.50	Q of the equalizer and sidechain filter
THRESHOLD	-80.0 to 10.0 dB	Threshold value at which processing begins to apply
RATIO	$\infty$ : 1 to 1 : 1.50	Sets the boost/cut ratio relative to the input signal
MODE	BELOW, ABOVE	Specifies whether the processor will operate when the sidechain signal exceeds the threshold setting (ABOVE) or when it falls below the threshold setting (BELOW)
ATTACK/RELEASE	FAST, SLOW, AUTO	Attack time/release time for when compression or boost is applied

## Automixer Parameters

Parameter	Range	Description
Group	a, b, c	Channel control field group
Override	OFF/ON	Turns on/off overriding of the channel control field
ChMode	man, auto, mute	Channel control field mode (man/auto/mute)
ChModePreset	man, auto, mute	Preset setting of the channel control field
Weight	-200 to 30	Relative sensitivity among input channels in the channel control field
MeterType	gain, input, output	Meter type of the master field
MasterOverride	OFF/ON	Turns on/off overriding of the master field
MasterMute	OFF/ON	Turns on/off the mute setting of the master field
Gain	0 to 127	Automixer gain displayed for each channel when the meter button of the master field is set to "gain"
InputLevel	0 to 127	Input level displayed for each channel when the meter button of the master field is set to "input"
OutputLevel	0 to 127	Output level displayed for each channel when the meter button of the master field is set to "output"
PostWeightingFilter	0 to 127	Level indicator of the channel control field

## Parameters that can be assigned to control changes

Mode	Parameter 1	Parameter 2
NO ASSIGN	—	0
FADER H	INPUT	CH 1–CH 64*1 STIN1L–STIN8R
	OUTPUT	MIX 1–MIX 16 MATRIX 1–MATRIX 8 STEREO L–MONO(C)
FADER L	INPUT	CH 1–CH 64*1 STIN1L–STIN8R
	OUTPUT	MIX 1–MIX 16 MATRIX 1–MATRIX 8 STEREO L–MONO(C)
CH ON	INPUT	CH 1–CH 64*1 STIN1L–STIN8R
	OUTPUT	MIX 1–MIX 16 MATRIX 1–MATRIX 8 STEREO L–MONO(C)
PHASE	INPUT	CH 1–CH 64*1 STIN1L–STIN8R
INSERT	INPUT	CH 1–CH 64*1
	OUTPUT	MIX 1–MIX 16 MATRIX 1–MATRIX 8 STEREO L–MONO(C)
DIRECT OUT	ON	CH 1–CH 64*1
PAN/BALANCE	INPUT	CH 1–CH 64*1 STIN1L–STIN8R
BALANCE	OUTPUT	MIX 1–MIX 16 MATRIX 1–MATRIX 8 STEREO L–STEREO R
TO STEREO	ON	CH 1–CH 64*1 STIN1L–STIN8R
TO MONO	ON	CH 1–CH 64*1 STIN1L–STIN8R
LCR	ON	CH 1–CH 64*1 STIN1L–STIN8R MIX 1–MIX 16
	CSR	
MIX/MATRIX SEND	MIX 1 ON – MIX 16 ON	CH 1–CH 64*1 STIN1L–STIN8R
	MATRIX 1 ON – MATRIX 8 ON	
	MIX 1 POINT – MIX 16 POINT	
	MATRIX 1 POINT – MATRIX 8 POINT	
	MIX 1 LEVEL H – MIX 16 LEVEL H	
	MIX 1 LEVEL L – MIX 16 LEVEL L	
	MATRIX 1 LEVEL H – MATRIX 8 LEVEL H	
	MATRIX 1 LEVEL L – MATRIX 8 LEVEL L	
	MIX 1/2 PAN – MIX 15/16 PAN	
MATRIX 1/2 PAN – MATRIX 7/8 PAN		
MIX TO STEREO	TO STEREO ON	MIX 1–MIX 16
	TO MONO ON	
	PAN	

Mode	Parameter 1	Parameter 2
MIX TO MATRIX	MATRIX 1 POINT – MATRIX 8 POINT	MIX 1–MIX 16
	MATRIX 1 ON – MATRIX 8 ON	
	MATRIX 1 LEVEL H – MATRIX 8 LEVEL H	
	MATRIX 1 LEVEL L – MATRIX 8 LEVEL L	
	MATRIX 1/2 PAN – MATRIX 7/8 PAN	
STEREO TO MATRIX	MATRIX 1 POINT – MATRIX 8 POINT	STEREO L–MONO(C)
	MATRIX 1 ON – MATRIX 8 ON	
	MATRIX 1 LEVEL H – MATRIX 8 LEVEL H	
	MATRIX 1 LEVEL L – MATRIX 8 LEVEL L	
	MATRIX 1/2 PAN – MATRIX 7/8 PAN	
INPUT EQ	ON	CH 1–CH 64*1 STIN1L–STIN8R
	LOW Q	
	LOW FREQ	
	LOW GAIN	
	LOW MID Q	
	LOW MID FREQ	
	LOW MID GAIN	
	HIGH MID Q	
	HIGH MID FREQ	
	HIGH MID GAIN	
	HIGH Q	
	HIGH FREQ	
	HIGH GAIN	
	LPF ON	
	LOW TYPE	
	HIGH TYPE	
HPF TYPE		
INPUT ATT	INPUT	CH 1–CH 64*1 STIN1L–STIN8R
INPUT HPF	ON	CH 1–CH 64*1 STIN1L–STIN8R
	FREQ	

Mode	Parameter 1	Parameter 2
OUTPUT EQ	ON	MIX 1–MIX 16 MATRIX 1–MATRIX 8 STEREO L–MONO(C)
	LOW Q	
	LOW FREQ	
	LOW GAIN	
	LOW MID Q	
	LOW MID FREQ	
	LOW MID GAIN	
	HIGH MID Q	
	HIGH MID FREQ	
	HIGH MID GAIN	
	HIGH Q	
	HIGH FREQ	
	HIGH GAIN	
	LOW TYPE	
	HIGH TYPE	
	LOW HPF ON	
HIGH LPF ON		
OUTPUT ATT	OUTPUT	MIX 1–MIX 16 MATRIX 1–MATRIX 8 STEREO L–MONO(C)
INPUT DYNAMICS1	ON	CH 1–CH 64*1 STIN1L–STIN8R
	ATTACK	
	THRESHOLD	
	RANGE	
	HOLD H	
	HOLD L	
	DECAY/RELEASE H	
	DECAY/RELEASE L	
	RATIO	
	KNEE/WIDTH	
	GAIN H	
GAIN L		
INPUT DYNAMICS2	ON	CH 1–CH 64*1 STIN1L–STIN8R
	ATTACK	
	THRESHOLD	
	RELEASE H	
	RELEASE L	
	RATIO	
	GAIN H	
	GAIN L	
	KNEE/WIDTH	
	FILTER FREQ	

Mode	Parameter 1	Parameter 2
OUTPUT DYNAMICS1	ON	MIX 1–MIX 16 MATRIX 1–MATRIX 8 STEREO L–MONO(C)
	ATTACK	
	THRESHOLD	
	RELEASE H	
	RELEASE L	
	RATIO	
	GAIN H	
	GAIN L	
	KNEE/WIDTH	
EFFECT	BYPASS	Rack1–8
	MIX BALANCE	
	PARAM 1 H – PARAM 32 L	
GEQ	ON A	Rack1–8
	ON B	
	GAIN A 1 – GAIN A 31	
	GAIN B 1 – GAIN B 31	
PREMIUM RACK A	BYPASS	Rack1–8
	PARAM 1 H – PARAM 64 L	
PREMIUM RACK B	BYPASS	Rack1–8
	PARAM 1 H – PARAM 64 L	
DCA	ON	DCA 1–DCA 16
	FADER H	
	FADER L	
MUTE MASTER	ON	MASTER 1–MASTER 8
RECALL SAFE	ON	CH 1–CH 64*1 STIN1L–STIN8R MIX 1–MIX 16 MATRIX 1–MATRIX 8 STEREO L–MONO(C) GEQ RACK 1A–8B EFFECT RACK 1A–8B PREMIUM RACK 1A–8B DCA 1–DCA16

\*1. QL1: CH1-CH32

# NRPN parameter assignments

Parameter	From (HEX)	To (HEX)	
FADER	INPUT	0000	0057
	MIX1-16, MATRIX, STEREO LR	0060	007D
INPUT to MIX9-16 LEVEL	MIX9 SEND	007E	00D5
	MIX10 SEND	00DE	0135
	MIX11 SEND	013E	0195
	MIX12 SEND	019E	01F5
	MIX13 SEND	01FE	0255
	MIX14 SEND	025E	02B5
	MIX15 SEND	02BE	0315
INPUT to MATRIX1-4 LEVEL	MIX16 SEND	031E	0375
	MATRIX1 SEND	037E	03D5
	MATRIX2 SEND	03DE	0435
	MATRIX3 SEND	043E	0495
MIX1-16, STEREO LR to MATRIX LEVEL	MATRIX4 SEND	049E	04F5
	MATRIX1 SEND	04FE	0513
	MATRIX2 SEND	0514	0529
	MATRIX3 SEND	052A	053F
	MATRIX4 SEND	0540	0555
	MATRIX5 SEND	0556	056B
	MATRIX6 SEND	056C	0581
	MATRIX7 SEND	0582	0597
ON	MATRIX8 SEND	0598	05AD
	INPUT	05B6	060D
INPUT to MIX9-16 ON	MIX1-16, MATRIX, STEREO LR	0616	0633
	MIX9 SEND	0634	068B
	MIX10 SEND	0694	06EB
	MIX11 SEND	06F4	074B
	MIX12 SEND	0754	07AB
	MIX13 SEND	07B4	080B
	MIX14 SEND	0814	086B
	MIX15 SEND	0874	08CB
INPUT to MATRIX1-4 ON	MIX16 SEND	08D4	092B
	MATRIX1 SEND	0934	098B
	MATRIX2 SEND	0994	09EB
	MATRIX3 SEND	09F4	0A4B
MIX1-16, STEREO LR to MATRIX ON	MATRIX4 SEND	0A54	0AAB
	MATRIX1 SEND	0AB4	0AC9
	MATRIX2 SEND	0ACA	0ADF
	MATRIX3 SEND	0AE0	0AF5
	MATRIX4 SEND	0AF6	0B0B
	MATRIX5 SEND	0B0C	0B21
MIX1-8 to STEREO ON PHASE	MATRIX6 SEND	0B22	0B37
	MATRIX7 SEND	0B38	0B4D
	MATRIX8 SEND	0B4E	0B63
	MIX TO ST	0B64	0B6B
INPUT	0B6C	0BC3	

Parameter	From (HEX)	To (HEX)	
INSERT ON	INPUT	0BCC	0C13
	MIX1-20, MATRIX, STEREO LR	0C2C	0C49
INPUT to MIX9-16 PRE/POST	MIX9 SEND	0C4A	0CA1
	MIX10 SEND	0CAA	0D01
	MIX11 SEND	0D0A	0D61
	MIX12 SEND	0D6A	0DC1
	MIX13 SEND	0DCA	0E21
	MIX14 SEND	0E2A	0E81
	MIX15 SEND	0E8A	0EE1
INPUT to MATRIX1-4 PRE/POST	MIX16 SEND	0EEA	0F41
	MATRIX1 SEND	0F4A	0FA1
	MATRIX2 SEND	0FAA	1001
INPUT57-64 to MIX1-8 LEVEL	MATRIX3 SEND	100A	1061
	MATRIX4 SEND	106A	10C1
	MIX1 SEND	10CA	10D1
	MIX2 SEND	10D2	10D9
	MIX3 SEND	10DA	10E1
	MIX4 SEND	10E2	10E9
	MIX5 SEND	10EA	10F1
	MIX6 SEND	10F2	10F9
INPUT57-64 to MATRIX5-8 LEVEL	MIX7 SEND	10FA	1101
	MIX8 SEND	1102	1109
	MATRIX5 SEND	110A	1111
	MATRIX6 SEND	1112	1119
INPUT57-64 to MIX1-8 ON	MATRIX7 SEND	111A	1121
	MATRIX8 SEND	1122	1129
	MIX1 SEND	112A	1131
	MIX2 SEND	1132	1139
	MIX3 SEND	113A	1141
	MIX4 SEND	1142	1149
	MIX5 SEND	114A	1151
	MIX6 SEND	1152	1159
INPUT57-64 to MATRIX5-8 ON	MIX7 SEND	115A	1161
	MIX8 SEND	1162	1169
	MATRIX5 SEND	116A	1171
	MATRIX6 SEND	1172	1179
INPUT57-64 to MIX1-8 PRE/POST	MATRIX7 SEND	117A	1181
	MATRIX8 SEND	1182	1189
	MIX1 SEND	118A	1191
	MIX2 SEND	1192	1199
	MIX3 SEND	119A	11A1
	MIX4 SEND	11A2	11A9
	MIX5 SEND	11AA	11B1
	MIX6 SEND	11B2	11B9
INPUT57-64 to MATRIX5-8 PRE/POST	MIX7 SEND	11BA	11C1
	MIX8 SEND	11C2	11C9
	MATRIX5 SEND	11CA	11D1
	MATRIX6 SEND	11D2	11D9
INPUT57-64 to MATRIX7 SEND	MATRIX7 SEND	11DA	11E1
	MATRIX8 SEND	11E2	11E9

Parameter	From (HEX)	To (HEX)	
INPUT57-64 EQ	LOW TYPE	11EA	11F1
	HIGH TYPE	11F2	11F9
INPUT57-64 HPF	FREQ	11FA	1201
INPUT57-64 to MIX1/2-7/8 PAN	MIX1/2	1202	1209
	MIX3/4	120A	1211
	MIX5/6	1212	1219
	MIX7/8	121A	1221
INPUT57-64 to MATRIX5/6, 7/8 PAN	MATRIX5/6	1222	1229
	MATRIX7/8	122A	1231
INPUT57-64 to STEREO SAFE	ON	1232	1239
INPUT57-64 RECALL	ON	123A	1241
INPUT57-64 to MONO	ON	1242	1249
INPUT49-64 DYNAMICS1	RATIO	124A	1259
	KNEE/WIDTH	125A	1269
	GAIN	126A	1279
INPUT49-64 DYNAMICS2	reserved	127A	1289
	FILTER FREQ	128A	1299
EQ INPUT, MIX1-16, MATRIX, STEREO LR	ON	1304	1381
	LOW Q	1382	13FF
	LOW FREQ	1400	147D
	LOW GAIN	147E	14FB
	LOW MID Q	14FC	1579
	LOW MID FREQ	157A	15F7
	LOW MID GAIN	15F8	1675
	HIGH MID Q	1676	16F3
	HIGH MID FREQ	16F4	1771
	HIGH MID GAIN	1772	17EF
	HIGH Q	17F0	186D
	HIGH FREQ	186E	18EB
	HIGH GAIN	18EC	1969
	ATT	196A	19C1
	HPF ON	19E8	1A65
	LPF ON	1A66	1AE3
	HPF TYPE		
INPUT DYNAMICS1	ON	1AE4	1B3B
	ATTACK	1B44	1B9B
	THRESHOLD	1BA4	1BF8
	RANGE	1C04	1C5B
	HOLD	1C64	1CBB
	DECAY/RELEASE	1CC4	1D1B
INPUT DYNAMICS2	ON	1D24	1DA1
MIX1-16, MATRIX, STEREO LR DYNAMICS1	ATTACK	1DA2	1E1F
	THRESHOLD	1E20	1E9D
	RELEASE	1E9E	1F1B
	RATIO	1F1C	1F99
	GAIN	1F9A	2017
PAN/BALANCE	KNEE/WIDTH	2018	2095
	INPUT	2096	20ED

Parameter	From (HEX)	To (HEX)
INPUT to MIX9/10-15/16 PAN	MIX9/10	20F6 214D
	MIX11/12	2156 21AD
	MIX13/14	21B6 220D
	MIX15/16	2216 226D
INPUT to MATRIX1/2, 3/4 PAN	MATRIX1/2	2276 22CD
	MATRIX3/4	22D6 232D
MIX1-20, STEREO LR to MATRIX PAN	MATRIX1/2	2336 234B
	MATRIX3/4	234C 2361
	MATRIX5/6	2362 2377
	MATRIX7/8	2378 238D
MIX1-8 to STEREO PAN	MIX TO ST	238E 2395
BALANCE	MIX1-20, MATRIX, STEREO LR	2396 23B3
MIX, STEREO LR, MONO to MATRIX PRE/POST	MATRIX1 SEND	23B4 23CE
	MATRIX2 SEND	23D0 23EA
	MATRIX3 SEND	23EC 2406
	MATRIX4 SEND	2408 2422
	MATRIX5 SEND	2424 243E
	MATRIX6 SEND	2440 245A
	MATRIX7 SEND	245C 2476
	MATRIX8 SEND	2478 2492
MONO to MATRIX ON	MATRIX1 SEND	2494 2498
	MATRIX2 SEND	249A 249E
	MATRIX3 SEND	24A0 24A4
	MATRIX4 SEND	24A6 24AA
	MATRIX5 SEND	24AC 24B0
	MATRIX6 SEND	24B2 24B6
	MATRIX7 SEND	24B8 24BC
	MATRIX8 SEND	24BE 24C2

Parameter	From (HEX)	To (HEX)
EFFECT RACK1-8	BYPASS	26B4 26BB
	MIX BALANCE	26BC 26C3
	PARAM1	26C4 26CB
	PARAM2	26CC 26D3
	PARAM3	26D4 26DB
	PARAM4	26DC 26E3
	PARAM5	26E4 26EB
	PARAM6	26EC 26F3
	PARAM7	26F4 26FB
	PARAM8	26FC 2703
	PARAM9	2704 270B
	PARAM10	270C 2713
	PARAM11	2714 271B
	PARAM12	271C 2723
	PARAM13	2724 272B
	PARAM14	272C 2733
	PARAM15	2734 273B
	PARAM16	273C 2743
	PARAM17	2744 274B
	PARAM18	274C 2753
	PARAM19	2754 275B
	PARAM20	275C 2763
	PARAM21	2764 276B
	PARAM22	276C 2773
	PARAM23	2774 277B
	PARAM24	277C 2783
	PARAM25	2784 278B
	PARAM26	278C 2793
	PARAM27	2794 279B
	PARAM28	279C 27A3
	PARAM29	27A4 27AB
	PARAM30	27AC 27B3
PARAM31	27B4 27BB	
PARAM32	27BC 27C3	

Parameter	From (HEX)	To (HEX)
GEQ RACK1A-3B	ON	27C4 27C9
	GAIN1	27CA 27CF
	GAIN2	27D0 27D5
	GAIN3	27D6 27DB
	GAIN4	27DC 27E1
	GAIN5	27E2 27E7
	GAIN6	27E8 27ED
	GAIN7	27EE 27F3
	GAIN8	27F4 27F9
	GAIN9	27FA 27FF
	GAIN10	2800 2805
	GAIN11	2806 280B
	GAIN12	280C 2811
	GAIN13	2812 2817
	GAIN14	2818 281D
	GAIN15	281E 2823
	GAIN16	2824 2829
	GAIN17	282A 282F
	GAIN18	2830 2835
	GAIN19	2836 283B
	GAIN20	283C 2841
	GAIN21	2842 2847
	GAIN22	2848 284D
	GAIN23	284E 2853
	GAIN24	2854 2859
	GAIN25	285A 285F
	GAIN26	2860 2865
	GAIN27	2866 286B
	GAIN28	286C 2871
	GAIN29	2872 2877
	GAIN30	2878 287D
GAIN31	287E 2883	
FADER	MIX21-24, MONO	28E4 28E8
INPUT1-56, STIN1-4 to MIX1-8 LEVEL	MIX1 SEND	28EA 2929
	MIX2 SEND	292A 2969
	MIX3 SEND	296A 29A9
	MIX4 SEND	29AA 29E9
	MIX5 SEND	29EA 2A29
	MIX6 SEND	2A2A 2A69
	MIX7 SEND	2A6A 2AA9
	MIX8 SEND	2AAA 2AE9
INPUT1-56, STIN1-4 to MATRIX5-8 LEVEL	MATRIX5 SEND	2AEA 2B29
	MATRIX6 SEND	2B2A 2B69
	MATRIX7 SEND	2B6A 2BA9
	MATRIX8 SEND	2BAA 2BE9

Parameter	From (HEX)	To (HEX)	
MONO to MATRIX LEVEL	MATRIX1 SEND	2BEA	2BEE
	MATRIX2 SEND	2BF0	2BF4
	MATRIX3 SEND	2BF6	2BFA
	MATRIX4 SEND	2BFC	2C00
	MATRIX5 SEND	2C02	2C06
	MATRIX6 SEND	2C08	2C0C
	MATRIX7 SEND	2C0E	2C12
	MATRIX8 SEND	2C14	2C18
ON	MONO	2C2A	2C2E
INPUT1-56, STIN1-4 to MIX1-8 ON	MIX1 SEND	2C30	2C6F
	MIX2 SEND	2C70	2CAF
	MIX3 SEND	2CB0	2CEF
	MIX4 SEND	2CF0	2D2F
	MIX5 SEND	2D30	2D6F
	MIX6 SEND	2D70	2DAF
	MIX7 SEND	2DB0	2DEF
	MIX8 SEND	2DF0	2E2F
INPUT1-56, STIN1-4 to MATRIX5-8 ON	MATRIX5 SEND	2E30	2E6F
	MATRIX6 SEND	2E70	2EAF
	MATRIX7 SEND	2EB0	2EEF
	MATRIX8 SEND	2EF0	2F2F
MIX9-16 to STEREO ON	MIX TO ST	2F36	2F45
INSERT	MONO	2F46	2F4A
INPUT1-56, STIN1-4 to MIX1-8 PRE/POST	MIX1 SEND	2F4C	2F8B
	MIX2 SEND	2F8C	2FCB
	MIX3 SEND	2FCC	300B
	MIX4 SEND	300C	304B
	MIX5 SEND	304C	308B
	MIX6 SEND	308C	30CB
	MIX7 SEND	30CC	310B
	MIX8 SEND	310C	314B
INPUT1-56, STIN1-4 to MATRIX5-8 PRE/POST	MATRIX5 SEND	314C	318B
	MATRIX6 SEND	318C	31CB
	MATRIX7 SEND	31CC	320B
	MATRIX8 SEND	320C	324B
DCA13-16	ON	324C	324F
	FADER	3252	3255

Parameter	From (HEX)	To (HEX)	
MONO EQ	ON	325E	3262
	LOW Q	3264	3268
	LOW FREQ	326A	326E
	LOW GAIN	3270	3274
	LOW MID Q	3276	327A
	LOW MID FREQ	327C	3280
	LOW MID GAIN	3282	3286
	HIGH MID Q	3288	328C
	HIGH MID FREQ	328E	3292
	HIGH MID GAIN	3294	3298
	HIGH Q	329A	329E
	HIGH FREQ	32A0	32A4
	HIGH GAIN	32A6	32AA
	HPF ON	32AC	32B0
	LPF ON	32B2	32B6
	INPUT1-56, STIN1-4 EQ	LOW TYPE	3440
HIGH TYPE		3480	34BF
MIX, MATRIX, STEREO LR, MONO EQ	LOW TYPE	34C0	34E2
	HIGH TYPE	34E4	3506
INPUT1-56, STIN1-4 HPF	FREQ	3640	367F
MONO DYNAMICS1	ON	3680	3684
	ATTACK	3686	368A
	THRESHOLD	368C	3690
	RELEASE	3692	3696
	RATIO	3698	369C
	GAIN	369E	36A2
	KNEE/WIDTH	36A4	36A8
	MIX1/2	36AA	36E9
INPUT1-56, STIN1-4 to MIX1/2-7/8 PAN	MIX3/4	36EA	3729
	MIX5/6	372A	3769
	MIX7/8	376A	37A9
	MATRIX5/6	37AA	37E9
INPUT1-56, STIN1-4 to MATRIX5/6, 7/8 PAN	MATRIX7/8	37EA	3829
	MATRIX1/2	382A	382E
MONO to MATRIX1/2-7/8 PAN	MATRIX3/4	3830	3834
	MATRIX5/6	3836	383A
	MATRIX7/8	383C	3840
	MIX TO ST	3842	3851

Parameter	From (HEX)	To (HEX)	
GEQ RACK4A-6B	ON	3852	3857
	GAIN1	3858	385D
	GAIN2	385E	3863
	GAIN3	3864	3869
	GAIN4	386A	386F
	GAIN5	3870	3875
	GAIN6	3876	387B
	GAIN7	387C	3881
	GAIN8	3882	3887
	GAIN9	3888	388D
	GAIN10	388E	3893
	GAIN11	3894	3899
	GAIN12	389A	389F
	GAIN13	38A0	38A5
	GAIN14	38A6	38AB
	GAIN15	38AC	38B1
	GAIN16	38B2	38B7
	GAIN17	38B8	38BD
	GAIN18	38BE	38C3
	GAIN19	38C4	38C9
	GAIN20	38CA	38CF
	GAIN21	38D0	38D5
	GAIN22	38D6	38DB
	GAIN23	38DC	38E1
	GAIN24	38E2	38E7
	GAIN25	38E8	38ED
	GAIN26	38EE	38F3
	GAIN27	38F4	38F9
	GAIN28	38FA	38FF
	GAIN29	3900	3905
	GAIN30	3906	390B
GAIN31	390C	3911	
LCR INPUT1-64, STIN1-4, MIX1-16	ON	3912	3969
	CSR	396A	39C1
DIRECT OUT INPUT1-64	ON	39C2	3A01
INPUT1-56, STIN1-4 TO STEREO	ON	3A02	3A41
DCA1-12	ON	3A42	3A4D
	FADER	3A4E	3A59
MUTE MASTER	ON	3A5A	3A61
RECALL SAFE	ON	3A66	3B05

Parameter	From (HEX)	To (HEX)	
EXTERNAL GAIN1	3B06	3B0B	
INPUT GAIN 1	3B0F	3B15	
EXTERNAL GAIN2	3B16	3B1B	
INPUT GAIN 2	3B1F	3B25	
EXTERNAL GAIN3	3B26	3B2B	
INPUT GAIN 3	3B2F	3B35	
EXTERNAL GAIN4	3B36	3B3B	
INPUT GAIN 4	3B3F	3B45	
EXTERNAL GAIN5	3B46	3B4B	
INPUT GAIN 5	3B4F	3B55	
EXTERNAL GAIN6	3B56	3B5B	
INPUT GAIN 6	3B5F	3B65	
EXTERNAL GAIN7	3B66	3B6B	
INPUT GAIN 7	3B6F	3B75	
EXTERNAL GAIN8	3B76	3B7B	
INPUT GAIN 8	3B7F	3B85	
EXTERNAL +48V 1	3B86	3B8B	
INPUT +48V 1	3B8F	3B95	
EXTERNAL +48V 2	3B96	3B9B	
INPUT +48V 2	3B9F	3BA5	
EXTERNAL +48V 3	3BA6	3BAB	
INPUT +48V 3	3BAF	3BB5	
EXTERNAL +48V 4	3BB6	3BBB	
INPUT +48V 4	3BBF	3BC5	
EXTERNAL +48V 5	3BC6	3BCB	
INPUT +48V 5	3BCF	3BD5	
EXTERNAL +48V 6	3BD6	3BDB	
INPUT +48V 6	3BDF	3BE5	
EXTERNAL +48V 7	3BE6	3BEB	
INPUT +48V 7	3BEF	3BF5	
EXTERNAL +48V 8	3BF6	3BFB	
INPUT +48V 8	3BFF	3C05	
EXTERNAL HPF1	3C06	3C0B	
INPUT HPF1	3C0F	3C15	
EXTERNAL HPF2	3C16	3C1B	
INPUT HPF2	3C1F	3C25	
EXTERNAL HPF3	3C26	3C2B	
INPUT HPF3	3C2F	3C35	
EXTERNAL HPF4	3C36	3C3B	
INPUT HPF4	3C3F	3C45	
EXTERNAL HPF5	3C46	3C4B	
INPUT HPF5	3C4F	3C55	
EXTERNAL HPF6	3C56	3C5B	
INPUT HPF6	3C5F	3C65	
EXTERNAL HPF7	3C66	3C6B	
INPUT HPF7	3C6F	3C75	
EXTERNAL HPF8	3C76	3C7B	
INPUT HPF8	3C7F	3C85	
INPUT1-56, STIN1-4 TO MONO	ON	3C86	3CC5
MIX1-16 TO MONO	ON	3CC6	3CD5

HA

Parameter	From (HEX)	To (HEX)	
SLOT OUT DELAY	ON	3CD6	3D05
	TIME HIGH	3D06	3D35
	TIME LOW	3D36	3D65
OMNI OUT DELAY	ON	3D66	3D6D
	TIME HIGH	3D76	3D7D
	TIME LOW	3D86	3D8D
DIGITAL OUT DELAY	ON	3D96	3D97
	TIME HIGH	3D98	3D99
	TIME LOW	3D9A	3D9B
INPUT1-48, STIN1-4 DYNAMICS1	RATIO	3D9C	3DD3
	KNEE/WIDTH	3DD4	3E0B
	GAIN	3E0C	3E43
INPUT1-48, STIN1-4 DYNAMICS2	reserved	3E44	3E7B
	FILTER FREQ	3E7C	3EB3
GEQ RACK7A-8B	ON	3EB4	3EB7
	GAIN1	3EB8	3EBB
	GAIN2	3EBC	3EBF
	GAIN3	3EC0	3EC3
	GAIN4	3EC4	3EC7
	GAIN5	3EC8	3ECB
	GAIN6	3ECC	3ECF
	GAIN7	3ED0	3ED3
	GAIN8	3ED4	3ED7
	GAIN9	3ED8	3EDB
	GAIN10	3EDC	3EDF
	GAIN11	3EE0	3EE3
	GAIN12	3EE4	3EE7
	GAIN13	3EE8	3EEB
	GAIN14	3EEC	3EEF
	GAIN15	3EF0	3EF3
	GAIN16	3EF4	3EF7
	GAIN17	3EF8	3EFB
	GAIN18	3EFC	3EFF
	GAIN19	3F00	3F03
	GAIN20	3F04	3F07
	GAIN21	3F08	3F0B
	GAIN22	3F0C	3F0F
	GAIN23	3F10	3F13
	GAIN24	3F14	3F17
	GAIN25	3F18	3F1B
	GAIN26	3F1C	3F1F
	GAIN27	3F20	3F23
	GAIN28	3F24	3F27
	GAIN29	3F28	3F2B
	GAIN30	3F2C	3F2F
	GAIN31	3F30	3F33
MIX, MATRIX, STEREO LR, MONO EQ	ATT	3F34	3F56



## Mixing parameter operation applicability

This table indicates which settings affect the behavior of each input channel and output channel parameter.

It also indicates whether or not they can be linked as stereo, and whether or not they are relevant to the RECALL SAFE, GLOBAL PASTE, and USER LEVEL settings, and a channel library.

### Input channels

Parameter		Stereo <sup>*1</sup>	CHANNEL LINK	RECALL SAFE, FOCUS RECALL, GLOBAL PASTE <sup>*8</sup>		USER LEVEL	Channel Library
				ALL	Parameter Select button		
HA	Gain	O <sup>*10</sup>	HA <sup>*10</sup>	O	HA, GLOBAL HA	HA	O
	Gain Compensation	O	HA	O	HA, GLOBAL HA	HA	O
	+48V			O	HA, GLOBAL HA	HA	O
	Phase			O	HA, GLOBAL HA	HA	O
Digital Gain		O <sup>*10</sup>	DIGITAL GAIN <sup>*10</sup>	O	DIGITAL GAIN	HA	O
Name, Icon, Color				O	INPUT NAME, GLOBAL INPUT NAME	INPUT NAME	O
Input Patch				O	INPUT PATCH, GLOBAL INPUT PATCH	INPUT PATCH	
Insert	Out Patch			O	INPUT INSERT PATCH, GLOBAL INPUT PATCH	INPUT PATCH	
	In Patch			O	INPUT INSERT PATCH, GLOBAL INPUT PATCH	INPUT PATCH	
	+48V, Gain, Gain Compensation				INPUT INSERT PATCH, GLOBAL HA	HA	
	On		INPUT INSERT	O	INPUT INSERT	INPUT PROCESSING	O
	Point		INPUT INSERT	O	INPUT INSERT	INPUT PROCESSING	O
Direct Out	Out Patch			O	INPUT DIRECT OUT, GLOBAL INPUT PATCH	INPUT PATCH	
	On, Level		DIRECT OUT	O	INPUT DIRECT OUT	INPUT PROCESSING	O
	Point		DIRECT OUT	O	INPUT DIRECT OUT	INPUT PROCESSING	O
HPF		O	INPUT HPF	O	INPUT HPF	INPUT PROCESSING	O
Att		O	INPUT EQ	O	INPUT EQ	INPUT PROCESSING	O
EQ		O	INPUT EQ	O	INPUT EQ	INPUT PROCESSING	O
Dynamics1	Key-In Source			O	INPUT DYNA1	INPUT PROCESSING	
	Key-In Filter	O	INPUT DYNAMICS1	O	INPUT DYNA1	INPUT PROCESSING	O
	Others	O	INPUT DYNAMICS1	O	INPUT DYNA1	INPUT PROCESSING	O
Dynamics2	Key-In Source			O	INPUT DYNA2	INPUT PROCESSING	
	Others	O	INPUT DYNAMICS2	O	INPUT DYNA2	INPUT PROCESSING	O
To Mix	On	O	INPUT MIX ON <sup>*2</sup>	O	INPUT MIX ON <sup>*7</sup>	INPUT FADER/ON <sup>*4</sup>	O
	Level	O	INPUT MIX SEND <sup>*2</sup>	O	INPUT MIX SEND <sup>*7</sup>	INPUT FADER/ON <sup>*4</sup>	O
	Pan/Balance	O <sup>*11</sup>		O	INPUT MIX SEND <sup>*7</sup>	INPUT FADER/ON <sup>*4</sup>	O
	Pre/Post	O	INPUT MIX SEND <sup>*2</sup>	O	INPUT MIX SEND <sup>*7</sup>	INPUT PROCESSING <sup>*4</sup>	O
To Matrix	On	O	INPUT MATRIX ON <sup>*3</sup>	O	INPUT MATRIX ON <sup>*7</sup>	INPUT FADER/ON <sup>*4</sup>	O
	Level	O	INPUT MATRIX SEND <sup>*3</sup>	O	INPUT MATRIX SEND <sup>*7</sup>	INPUT FADER/ON <sup>*4</sup>	O
	Pan/Balance	O <sup>*11</sup>		O	INPUT MATRIX SEND <sup>*7</sup>	INPUT FADER/ON <sup>*4</sup>	O
	Pre/Post	O	INPUT MATRIX SEND <sup>*3</sup>	O	INPUT MATRIX SEND <sup>*7</sup>	INPUT PROCESSING <sup>*4</sup>	O
DELAY	ms	O <sup>*10</sup>	INPUT DELAY <sup>*10</sup>	O	INPUT DELAY	INPUT PROCESSING	O
	ON	O	INPUT DELAY	O	INPUT DELAY	INPUT PROCESSING	O
To Stereo		O	TO STEREO	O	INPUT TO ST	INPUT PROCESSING	O
To Mono		O	TO STEREO	O	INPUT TO MONO	INPUT PROCESSING	O

Parameter	Stereo*1	CHANNEL LINK	RECALL SAFE, FOCUS RECALL, GLOBAL PASTE*8		USER LEVEL	Channel Library
			ALL	Parameter Select button		
Pan/balance	O*11		O	INPUT TO ST	INPUT FADER/ON	O
Pan Mode	O		O	*5	INPUT PROCESSING	O
LCR	On	TO STEREO	O	*5	INPUT PROCESSING	O
	CSR	TO STEREO	O	*5	INPUT PROCESSING	O
	Mode	TO STEREO	O	*5	INPUT PROCESSING	O
On	O	INPUT CH ON	O	INPUT CH ON	INPUT FADER/ON	O
Fader	O*10	INPUT FADER*10	O	INPUT FADER	INPUT FADER/ON	O
Mute Assign	O	INPUT MUTE	O	*5	MUTE GROUP ASSIGN	O
DCA Assign	O	INPUT DCA	O	*5	DCA GROUP ASSIGN	O
Fade Time, On	O*6		O	*9	STORE	O*6
Channel Link	O			GLOBAL CH LINK		
Cue	O					
Key In Cue						
Mute Safe	O					
Recall Safe, Focus Recall, Global Paste	O					

\*1 These parameters can be linked between L and R of ST IN channels 1–8.

\*2 Applies to parameters for which the MIX channel 1–16 individual Send Parameter setting and the item in the table are both enabled.

\*3 Applies to parameters for which the MATRIX channel 1–8 individual Send Parameter setting and the item in the table are both enabled.

\*4 These parameters are available if "FADER/ON" or "PROCESSING" for the Send source channel is set to ON. At that time, "WITH SEND" for the Send destination channel must also be set to ON.

\*5 Applicable to parameters that function only when ALL is selected.

\*6 Applicable only to On/Off.

\*7 Valid when they are set for either the Send source channel or Send destination channel.

\*8 Settings marked GLOBAL in this table apply to all channels; these settings are GLOBAL RECALL SAFE, FOCUS PARAMETER, and GLOBAL PASTE for PATCH/NAME.

\*9 Applies to ALL only when using GLOBAL PASTE, and only to ON/OFF.

\*10 Operates differentially

\*11 Balance only

## MIX Channels

Parameter	Linked for a stereo pair	RECALL SAFE, FOCUS RECALL, GLOBAL PASTE *8, *12		USER LEVEL	Channel Library	
		ALL	Parameter Select button			
Name, Icon, Color		<input type="radio"/>	MIX NAME, GLOBAL OUTPUT NAME	OUTPUT NAME	<input type="radio"/>	
Output Patch		<input type="radio"/>	MIX OUTPUT PATCH, GLOBAL OUTPUT PATCH	OUTPUT PATCH		
Insert	Out Patch		MIX INSERT PATCH, GLOBAL OUTPUT PATCH	OUTPUT PATCH		
	In Patch		MIX INSERT PATCH, GLOBAL OUTPUT PATCH	OUTPUT PATCH		
	+48V, Gain, Gain Compensation		MIX INSERT PATCH, GLOBAL HA	MIX PROCESSING		
	On	<input type="radio"/>	<input type="radio"/>	MIX INSERT	MIX PROCESSING	<input type="radio"/>
	Point	<input type="radio"/>	<input type="radio"/>	MIX INSERT	MIX PROCESSING	<input type="radio"/>
Att	<input type="radio"/>	<input type="radio"/>	MIX EQ	MIX PROCESSING	<input type="radio"/>	
EQ	<input type="radio"/>	<input type="radio"/>	MIX EQ	MIX PROCESSING	<input type="radio"/>	
Dynamics1	Key-In Source		<input type="radio"/>	MIX DYNA1	MIX PROCESSING	
	Others	<input type="radio"/>	<input type="radio"/>	MIX DYNA1	MIX PROCESSING	<input type="radio"/>
To Matrix	On	<input type="radio"/>	<input type="radio"/>	MIX MATRIX ON*7	MIX FADER/ON*4	<input type="radio"/>
	Level	<input type="radio"/> *13	<input type="radio"/>	MIX MATRIX SEND*7	MIX FADER/ON*4	<input type="radio"/>
	Pan/Balance	<input type="radio"/>	<input type="radio"/>	MIX MATRIX SEND*7	MIX FADER/ON*4	<input type="radio"/>
	Pre/Post	<input type="radio"/>	<input type="radio"/>	MIX MATRIX SEND*7	MIX PROCESSING*4	<input type="radio"/>
To Stereo	<input type="radio"/>	<input type="radio"/>	MIX TO ST	MIX PROCESSING	<input type="radio"/>	
To Mono	<input type="radio"/>	<input type="radio"/>	MIX MONO	MIX PROCESSING	<input type="radio"/>	
Pan/Balance	<input type="radio"/> *11	<input type="radio"/>	MIX TO ST, TO ST/BAL (GLOBAL PASTE ONLY)	MIX FADER/ON	<input type="radio"/>	
LCR	On	<input type="radio"/>	<input type="radio"/>	*5	MIX PROCESSING	<input type="radio"/>
	CSR	<input type="radio"/>	<input type="radio"/>	*5	MIX PROCESSING	<input type="radio"/>
	Mode	<input type="radio"/>	<input type="radio"/>	*5	MIX PROCESSING	<input type="radio"/>
On	<input type="radio"/>	<input type="radio"/>	MIX CH ON	MIX FADER/ON	<input type="radio"/>	
Fader	<input type="radio"/>	<input type="radio"/>	MIX FADER	MIX FADER/ON	<input type="radio"/>	
From Input	On	<input type="radio"/>		WITH MIX SEND, WITH SEND FROM SOURCE CHs	WITH MIX SEND*4	
	Level	<input type="radio"/>		WITH MIX SEND, WITH SEND FROM SOURCE CHs	WITH MIX SEND*4	
	Pan/Balance	<input type="radio"/> *11		WITH MIX SEND, WITH SEND FROM SOURCE CHs	WITH MIX SEND*4	
	Pre/Post	<input type="radio"/>		WITH MIX SEND, WITH SEND FROM SOURCE CHs	WITH MIX SEND*4	
Mute Assign	<input type="radio"/>	<input type="radio"/>	*5	MUTE GROUP ASSIGN	<input type="radio"/>	
Fade Time, On	<input type="radio"/> *6	<input type="radio"/>	*9	STORE	<input type="radio"/> *6	
Cue	<input type="radio"/>					
Mute Safe	<input type="radio"/>					
Recall Safe, Focus Recall, Global Paste	<input type="radio"/>					

\*4 These parameters are available if "FADER/ON" or "PROCESSING" for the Send source channel is set to ON. At that time, "WITH SEND" for the Send destination channel must also be set to ON.

\*5 Applicable to parameters that function only when ALL is selected.

\*6 Applicable only to On/Off.

\*7 Valid when they are set for either the Send source channel or Send destination channel.

\*8 Settings marked GLOBAL in this table apply to all channels; these settings are GLOBAL RECALL SAFE, FOCUS PARAMETER, and GLOBAL PASTE for PATCH/NAME.

\*9 Applies to ALL only when using GLOBAL PASTE, and only to ON/OFF.

\*11 Balance only

\*12 For GLOBAL PASTE, the MIX, MATRIX, STEREO, and MONO settings of each channel will be set in common as the OUTPUT.

\*13 Linked only for stereo MATRIX

## MATRIX Channels

Parameter		Linked for a stereo pair	RECALL SAFE, FOCUS RECALL, GLOBAL PASTE *8, *12		USER LEVEL	Channel Library
			ALL	Parameter Select button		
Name, Icon, Color			<input type="radio"/>	MATRIX NAME, GLOBAL OUTPUT NAME	OUTPUT NAME	<input type="radio"/>
Output Patch			<input type="radio"/>	MATRIX OUTPUT PATCH, GLOBAL OUTPUT PATCH	OUTPUT PATCH	
Insert	Out Patch		<input type="radio"/>	MATRIX INSERT PATCH, GLOBAL OUTPUT PATCH	OUTPUT PATCH	
	In Patch		<input type="radio"/>	MATRIX INSERT PATCH, GLOBAL OUTPUT PATCH	OUTPUT PATCH	
	+48V, Gain, Gain Compensation		<input type="radio"/>	MATRIX INSERT PATCH, GLOBAL HA	MATRIX PROCESSING	
	On	<input type="radio"/>	<input type="radio"/>	MATRIX INSERT	MATRIX PROCESSING	<input type="radio"/>
	Point	<input type="radio"/>	<input type="radio"/>	MATRIX INSERT	MATRIX PROCESSING	<input type="radio"/>
Att		<input type="radio"/>	<input type="radio"/>	MATRIX EQ	MATRIX PROCESSING	<input type="radio"/>
EQ		<input type="radio"/>	<input type="radio"/>	MATRIX EQ	MATRIX PROCESSING	<input type="radio"/>
Dynamics1	Key-In Source		<input type="radio"/>	MATRIX DYNA1	MATRIX PROCESSING	
	Others	<input type="radio"/>	<input type="radio"/>	MATRIX DYNA1	MATRIX PROCESSING	<input type="radio"/>
Balance		<input type="radio"/>	<input type="radio"/>	MATRIX BAL, TO ST/BAL (GLOBAL PASTE ONLY)	MATRIX FADER/ON	<input type="radio"/>
On		<input type="radio"/>	<input type="radio"/>	MATRIX CH ON	MATRIX FADER/ON	<input type="radio"/>
Fader		<input type="radio"/>	<input type="radio"/>	MATRIX FADER	MATRIX FADER/ON	<input type="radio"/>
From Input From Mix From Stereo/Mono	On	<input type="radio"/>		WITH MATRIX SEND, WITH SEND FROM SOURCE CHs	WITH MATRIX SEND*4	
	Level	<input type="radio"/>		WITH MATRIX SEND, WITH SEND FROM SOURCE CHs	WITH MATRIX SEND*4	
	Pan/Balance	<input type="radio"/> *11		WITH MATRIX SEND, WITH SEND FROM SOURCE CHs	WITH MATRIX SEND*4	
	Pre/Post	<input type="radio"/>		WITH MATRIX SEND, WITH SEND FROM SOURCE CHs	WITH MATRIX SEND*4	
Mute Assign		<input type="radio"/>	<input type="radio"/>	*5	MUTE GROUP ASSIGN	<input type="radio"/>
Fade Time, On		<input type="radio"/> *6	<input type="radio"/>	*9	STORE	<input type="radio"/> *6
Cue		<input type="radio"/>				
Mute Safe		<input type="radio"/>				
Recall Safe, Focus Recall, Global Paste		<input type="radio"/>				

\*4 These parameters are available if "FADER/ON" or "PROCESSING" for the Send source channel is set to ON. At that time, "WITH SEND" for the Send destination channel must also be set to ON.

\*5 Applicable to parameters that function only when ALL is selected.

\*6 Applicable only to On/Off.

\*7 Valid when they are set for either the Send source channel or Send destination channel.

\*8 Settings marked GLOBAL in this table apply to all channels; these settings are GLOBAL RECALL SAFE, FOCUS PARAMETER, and GLOBAL PASTE for PATCH/NAME.

\*9 Applies to ALL only when using GLOBAL PASTE, and only to ON/OFF.

\*11 Balance only

\*12 For GLOBAL PASTE, the MIX, MATRIX, STEREO, and MONO settings of each channel will be set in common as the OUTPUT.

## ■ STEREO, MONO Channels

Parameter	Linked for a stereo pair	RECALL SAFE, FOCUS RECALL, GLOBAL PASTE *8, *12		USER LEVEL	Channel Library	
		ALL	Parameter Select button			
Name, Icon, Color		O	STEREO, MONO NAME, GLOBAL OUTPUT NAME	OUTPUT NAME	O	
Output Patch		O	STEREO, MONO OUTPUT PATCH, GLOBAL OUTPUT PATCH	OUTPUT PATCH		
Insert	Out Patch		STEREO, MONO INSERT PATCH, GLOBAL OUTPUT PATCH	OUTPUT PATCH		
	In Patch		STEREO, MONO INSERT PATCH, GLOBAL OUTPUT PATCH	OUTPUT PATCH		
	+48V, Gain, Gain Compensation		STEREO, MONO INSERT PATCH, GLOBAL HA	STEREO, MONO PROCESSING		
	On	O	O	STEREO, MONO INSERT	STEREO, MONO PROCESSING	O
	Point	O	O	STEREO, MONO INSERT	STEREO, MONO PROCESSING	O
Att	O	O	STEREO, MONO EQ	STEREO, MONO PROCESSING	O	
EQ	O	O	STEREO, MONO EQ	STEREO, MONO PROCESSING	O	
Dynamics <sup>1</sup>	Key-In Source		STEREO, MONO DYNA1	STEREO, MONO PROCESSING		
	Others	O	O	STEREO, MONO DYNA1	STEREO, MONO PROCESSING	O
To Matrix	On	O	O	STEREO, MONO MATRIX ON* <sup>7</sup>	STEREO, MONO FADER/ON* <sup>4</sup>	O
	Level	O* <sup>13</sup>	O	STEREO, MONO MATRIX SEND* <sup>7</sup>	STEREO, MONO FADER/ON* <sup>4</sup>	O
	Pan/Balance	O	O	STEREO, MONO MATRIX SEND* <sup>7</sup>	STEREO, MONO FADER/ON* <sup>4</sup>	O
	Pre/Post	O	O	STEREO, MONO MATRIX SEND* <sup>7</sup>	STEREO, MONO PROCESSING* <sup>4</sup>	O
Balance	O	O	STEREO, MONO BAL, TO ST/BAL (GLOBAL PASTE ONLY)	STEREO, MONO FADER/ON	O	
On	O	O	STEREO, MONO CH ON	STEREO, MONO FADER/ON	O	
Fader	O	O	STEREO, MONO FADER	STEREO, MONO FADER/ON	O	
Mute Assign	O	O	* <sup>5</sup>	MUTE GROUP ASSIGN	O	
Fade Time, On	O* <sup>6</sup>	O	* <sup>9</sup>	STORE	O* <sup>6</sup>	
Cue	O					
Mute Safe	O					
Recall Safe, Focus Recall, Global Paste	O					

\*4 These parameters are available if "FADER/ON" or "PROCESSING" for the Send source channel is set to ON. At that time, "WITH SEND" for the Send destination channel must also be set to ON.

\*5 Applicable to parameters that function only when ALL is selected.

\*6 Applicable only to On/Off.

\*7 Valid when they are set for either the Send source channel or Send destination channel.

\*8 Settings marked GLOBAL in this table apply to all channels; these settings are GLOBAL RECALL SAFE, FOCUS PARAMETER, and GLOBAL PASTE for PATCH/NAME.

\*9 Applies to ALL only when using GLOBAL PASTE, and only to ON/OFF.

\*12 For GLOBAL PASTE, the MIX, MATRIX, STEREO, and MONO settings of each channel will be set in common as the OUTPUT.

## ■ DCA

Parameter	RECALL SAFE, FOCUS RECALL, GLOBAL PASTE		USER LEVEL
	ALL	Parameter Select button	
Name, Icon, Color	O	* <sup>5</sup>	DCA MASTER
On	O	DCA LEVEL/ON	DCA MASTER
Fader	O	DCA LEVEL/ON	DCA MASTER
Fade Time, On	O	* <sup>9</sup>	STORE
Input	DCA Assign		DCA GROUP ASSIGN

\*5 Applicable to parameters that function only when ALL is selected.

\*9 Applies to ALL only when using GLOBAL PASTE, and only to ON/OFF.

## ■ MUTE

Parameter	RECALL SAFE		USER LEVEL
	ALL		
Name	O		MUTE GROUP MASTER
On			MUTE GROUP MASTER
Dimmer			MUTE GROUP MASTER
MUTE Assign			MUTE GROUP ASSIGN

# MIDI Data Format

This section explains the format of the data that the QL series is able to understand, send, and receive.

## 1 CHANNEL MESSAGE

### 1.1 NOTE OFF (8n)

#### Reception

These messages are echoed to MIDI OUT if [OTHER COMMAND ECHO] is ON. They are received if [Rx CH] matches, and used to control effects.

STATUS	1000nnnn	8n	Note off message
DATA	0nnnnnnnn	nn	Note number
	0vvvvvvvv	vv	Velocity (ignored)

### 1.2 NOTE ON (9n)

#### Reception

These messages are echoed to MIDI OUT if [OTHER COMMAND ECHO] is ON. They are received if [Rx CH] matches, and used to control effects.

STATUS	1001nnnn	9n	Note on message
DATA	0nnnnnnnn	nn	Note number
	0vvvvvvvv	vv	Velocity (1-127:on, 0:off)

### 1.3 CONTROL CHANGE (Bn)

Two types of CONTROL CHANGE can be transmitted and received; [NRPN] (Non-Registered Parameter Numbers) and freely-assigned [TABLE] (1CH x 110) messages. Select either [TABLE] or [NRPN].

#### Reception

These messages are echoed to MIDI OUT if [CONTROL CHANGE ECHO] is ON. If [TABLE] is selected, these messages are received when [CONTROL CHANGE Rx] is ON and [Rx CH] matches, and will control parameters according to the settings of the [CONTROL CHANGE EVENT LIST]. For the parameters that can be assigned, refer to “Parameters that can be assigned to control changes” (page 22).

If [NRPN] is selected, these messages are received when [CONTROL CHANGE Rx] is ON and the [Rx CH] matches; the four messages NRPN control number (62h, 63h) and DATA ENTRY control number (06h, 26h) are used to control the specified parameter.

#### Transmission

If [TABLE] is selected, and if [CONTROL CHANGE Tx] is ON when you operate a parameter that is assigned in the [CONTROL CHANGE EVENT LIST], these messages will be transmitted on the [Tx CH] channel. For the parameters that can be assigned, refer to “Parameters that can be assigned to control changes” (page 22).

If [NRPN] is selected, and if [CONTROL CHANGE Tx] is ON when you operate a specified parameter, the four messages NRPN control number (62h, 63h) and DATA ENTRY control number (06h, 26h) are transmitted on the [Tx CH] channel. For the parameters that can be assigned, refer to “Parameters that can be assigned to control changes” (page 22).

CONTROL CHANGE messages are not used for transmission to QL Editor because there is no guarantee that the contents of the assignment tables will match. (PARAMETER CHANGE messages are always used.)

CONTROL CHANGE numbers 0 and 32 are for selecting banks.

STATUS	1011nnnn	Bn	Control change
DATA	00		Control number (00)
	0vvvvvvvv	vv	Control Value (0-127)
STATUS	1011nnnn	Bn	Control change
DATA	20		Control number (32)
	0vvvvvvvv	vv	Control Value (0-127)

#### If [TABLE] is selected

STATUS	1011nnnn	Bn	Control change
DATA	0nnnnnnnn	nn	Control number (1-5, 7-31, 33-37, 38-95, 102-119) *
	0vvvvvvvv	vv	Control Value (0-127)

\* Numbers 0, 32, and 96-01 cannot be used.

\* Control number 6, 38 can be used.

#### Equation for converting a Control Value to parameter data

paramSteps = paramMax – paramMin + 1;  
 add = paramWidth / paramSteps;  
 mod = paramWidth – add \* paramSteps;  
 curValue = paramSteps \* add + mod / 2;

#### (1) If the assigned parameter has fewer than 128 steps

paramWidth = 128; rxValue = Control value;

#### (2) If the assigned parameter has 128 or more but less than 16,384 steps

paramWidth = 16384;

(2-1) When High and Low data is received  
 rxValue = Control value(High) \* 128 + Control value(Low);

(2-2) When only Low data is received  
 rxValue = (curValue & 16256) + Control value(Low);

(2-3) When only High data is received  
 rxValue = Control value(High) \* 128 + (curValue & 127);

#### (3) If the assigned parameter has 16,384 or more but less than 2,097,152 steps

paramWidth = 2097152;

(3-1) When High, Middle, and Low data is received  
 rxValue = Control value(High) \* 16384 + Control value(Middle) \* 128 + Control value(Low);

(3-2) When only Low data is received  
 rxValue = (curValue & 2097024) + Control value(Low);

(3-3) When only Middle data is received  
 rxValue = (curValue & 2080895) + Control value(Middle) \* 128;

(3-4) When only High data is received  
 rxValue = (curValue & 16383) + Control value(High) \* 16384;

(3-5) When only Middle and Low data is received  
 rxValue = (curValue & 2080768) + Control value(Middle) \* 128 + Control value(Low);

(3-6) When only High and Low data is received  
 rxValue = (curValue & 16256) + Control value(High) \* 16384 + Control value(Low);

(3-7) When only High and Middle data is received  
 rxValue = (curValue & 127) + Control value(High) \* 16384 + Control value(Middle) \* 128;

if ( rxValue > paramWidth)  
 rxValue = paramWidth;  
 param = ( rxValue – mod / 2) / add;

#### If [NRPN] is selected

STATUS	1011nnnn	Bn	Control change
DATA	01100010	62	NRPN LSB
	0vvvvvvvv	vv	Parameter number LSB
STATUS	1011nnnn	Bn	Control change *
DATA	01100011	63	NRPN MSB
	0vvvvvvvv	vv	Parameter number MSB
STATUS	1011nnnn	Bn	Control change *
DATA	00000110	06	Data entry MSB
	0vvvvvvvv	vv	Parameter data MSB
STATUS	1011nnnn	Bn	Control change *
DATA	00100110	26	Data entry LSB
	0vvvvvvvv	vv	Parameter data LSB

\* The STATUS byte of the second and subsequent messages need not be added during transmission. Reception must occur correctly whether or not the status byte is omitted.

### 1.4 PROGRAM CHANGE (Cn)

#### Reception

If [PROGRAM CHANGE ECHO] is ON, bank select messages will also be echoed from MIDI OUT.

If SINGLE CH is selected, these messages are received if [PROGRAM CHANGE Rx] is ON and the [Rx CH] matches. However if [OMNI] is ON, these messages are received regardless of the channel. When these messages are received, scene memory, effect library and premium rack library are recalled according to the settings of the [PROGRAM CHANGE EVENT LIST].

#### Transmission

If [PROGRAM CHANGE Tx] is ON, these messages are transmitted according to the [PROGRAM CHANGE Table] settings when scene memory, effect library and premium rack library are recalled.

If SINGLE CH is selected, these messages are transmitted on the [Tx CH] channel. If the recalled scene memory, effect library and premium rack library have been assigned to more than one PROGRAM NUMBER, the lowest-numbered PROGRAM NUMBER for each MIDI channel will be transmitted. PROGRAM CHANGE messages are not used for transmission to QL Editor because there is no guarantee that the contents of the assignment tables will match. (PARAMETER CHANGE messages are always used.) You can choose either MULTI MIDI CH or SINGLE CH.

#### If SINGLE is selected

You can choose the Rx CH, OMNI CH, and Tx CH. You can choose whether a bank select message will be added. A bank of up to 16 can be specified.

#### If MULTI is selected

The Rx and Tx channels will be the same. The assignment table will use the settings for each MIDI channel. Bank select messages will not be added.

You can make settings for up to sixteen MIDI channels.

STATUS	1100nnnn	Cn	Program change
DATA	0nnnnnnnn	nn	Program number (0-127)

## 2 SYSTEM REALTIME MESSAGE

### 2.1 SONG SELECT (F3)

#### Reception

Select the track number shown in the TITLE LIST screen of the USB memory recorder.

```
STATUS      11110011 F3 Song select
Song number 0sssssss ss Song number (0-127)
```

### 2.2 TIMING CLOCK (F8)

#### Reception

This message is used to control effects. This message is transmitted twenty-four times per quarter note.

Echoing of this message depends on the OTHER item in the ECHO settings.

```
STATUS      11111000 F8 Timing clock
```

### 2.3 ACTIVE SENSING (FE)

#### Reception

Once this message has been received, MIDI communication will be initialized (e.g., Running Status will be cleared) if no message is received for an interval of 400 ms. This message is not subject to echoing.

```
STATUS      11111110 FE Active sensing
```

### 2.4 SYSTEM RESET (FF)

#### Reception

When this message is received, MIDI communication will be initialized (e.g., Running Status will be cleared). This message is not subject to echoing.

```
STATUS      11111111 FF System reset
```

## 3 SYSTEM EXCLUSIVE MESSAGE

### 3.1 MMC

#### < MMC STOP >

#### Reception

If the [DEVICE NO.] matches or is 7F, receives this message and stops.

```
STATUS      11110000 F0 System exclusive message
ID No.      01111111 7F Real time System exclusive
Device ID   0ddddddd dd Destination (00-7E, 7F:all call)
COMMAND     00000110 06 Machine Control Command(MCC) sub-id
            00000001 01 Stop(MCS)
EOX         11110111 F7 End of exclusive
```

#### < MMC PLAY >

#### Reception

If the [DEVICE NO.] matches or is 7F, receives this message and starts playback.

```
STATUS      11110000 F0 System exclusive message
ID No.      01111111 7F Real time System exclusive
Device ID   0ddddddd dd Destination (00-7E, 7F:all call)
COMMAND     00000110 06 Machine Control Command(MCC) sub-id
            00000010 02 Play(MCS)
EOX         11110111 F7 End of exclusive
```

#### < MMC DEFERED PLAY >

#### Reception

If the [DEVICE NO.] matches or is 7F, receives this message and starts playback.

```
STATUS      11110000 F0 System exclusive message
ID No.      01111111 7F Real time System exclusive
Device ID   0ddddddd dd Destination (00-7E, 7F:all call)
COMMAND     00000110 06 Machine Control Command(MCC) sub-id
            00000011 03 Deferred Play(MCS)
EOX         11110111 F7 End of exclusive
```

#### < MMC RECORD STROBE >

#### Reception

If the [DEVICE NO.] matches or is 7F, receives this message, and if stopped, starts recording.

```
STATUS      11110000 F0 System exclusive message
ID No.      01111111 7F Real time System exclusive
Device ID   0ddddddd dd Destination (00-7E, 7F:all call)
COMMAND     00000110 06 Machine Control Command(MCC) sub-id
            00000110 06 Record strobe
EOX         11110111 F7 End of exclusive
```

#### < MMC PAUSE >

#### Reception

If the [DEVICE NO.] matches or is 7F, receives this message, and if playing, pauses.

```
STATUS      11110000 F0 System exclusive message
ID No.      01111111 7F Real time System exclusive
Device ID   0ddddddd dd Destination (00-7E, 7F:all call)
COMMAND     00000110 06 Machine Control Command(MCC) sub-id
            00001001 09 Pause(MCS)
EOX         11110111 F7 End of exclusive
```

### 3.2 BULK DUMP

This message is used to send or receive the contents of various memories stored within the unit.

The basic format is as follows.

Command	rx/tx	Function
F0 43 0n 3E cc cc 19 mm ... mm dd dd ... ee F7	rx/tx	BULK DUMP DATA
F0 43 2n 3E 19 mm ... mm dd dd F7	rx	BULK DUMP REQUEST

The QL series console uses the following data types for a bulk dump.

Module Name(mm)		Data Number(dd)
SCENE LIB	"SCENE_"	*1) *14) *15) *16)
INPUT EQ LIB	"INEQ_"	*2) *7) *8)
OUTPUT EQ LIB	"OUTEQ_"	*3) *9) *10) *11)
Dynamics LIB	"DYNA_"	*4) *7) *8) *9) *10) *11) *21) *22)
INPUT CH LIB	"INCHNNL_"	*17) *7) *8)
OUTPUT CH LIB	"OUTCHNNL"	*18) *9) *10) *11)
GEQ LIB	"GEQ_"	*5) *12)
EFFECT LIB	"EFFECT_"	*6) *13)
Premium Effect	"PEFFECT_"	*19)
Portico5033 LIB	"P5033_"	*20)
Portico5043 LIB	"P5043_"	*20)
U76 LIB	"U76_"	*20)
Opt-2A LIB	"OPT-2A_"	*20)

Module Name(mm)		Data Number(dd)
EQP-1A LIB	"EQ-1A_"	*20)
DynamicEQ LIB	"DYNAEQ_"	*20)
Dante Input Patch LIB	"DANTEIN_"	*23)
Mixer Setup	"MIXERSET"	Fix (512)
Outport Setup	"OUT_PORT"	Fix (512)
Monitor Setup	"MONITOR_"	Fix (512)
MIDI Setup	"MIDI_SET"	Fix (512)
Lib Number	"LIB_NUM_"	Fix (512)
Program Change Table	"PRGMCHG_"	Fix (512)
Control Change Table	"CTRLCHG_"	Fix (512)
Preference (Current)	"PREF_CUR"	Fix (512)
Preference (Admin)	"PREF_ADM"	Fix (512)
Preference (Guest)	"PREF_GST"	Fix (512)
User Defined Keys (Current)	"UDEF_CUR"	Fix (512) include Knob, Encoder
User Defined Keys (Admin)	"UDEF_ADM"	Fix (512) include Knob, Encoder
User Defined Keys (Guest)	"UDEF_GST"	Fix (512) include Knob, Encoder
Custom Fader Bank (Current)	"CFAD_CUR"	Fix (512)
Custom Fader Bank (Admin)	"CFAD_ADM"	Fix (512)
Custom Fader Bank (Guest)	"CFAD_GST"	Fix (512)
User Level (Current)	"UKEY_CUR"	Fix (512)
User Level (Guest)	"UKEY_GST"	Fix (512)

- \*1) 0-300 Scene Number (0 Request Only),
- \*2) 1-199 Input EQ Library Number (1-40 Request Only)
- \*3) 1-199 Output EQ Library Number (1-3 Request Only)
- \*4) 1-199 Dynamics Library Number (1-41 Request Only)
- \*5) 0-199 GEQ Library Number (0 Request Only)
- \*6) 1-199 Effect Library Number (1-27 Request Only)
- \*7) 512-583 Input 1-64,
- \*8) 584-599 STIN 1L-8R,
- \*9) 768-791 MIX 1-16,
- \*10) 1024-1031 MATRIX 1-8,
- \*11) 1280-1282 STEREO L-C,
- \*12) 512-530 GEQ 1-19, 531-538 EFFECT GEQ 1-8,
- \*13) 512-519 EFFECT 1-8,
- \*14) 512 Current Data,
- \*15) 768 Current Data with Recall Safe,
- \*16) 8192 Store Undo Data, 8193 Recall Undo Data, 8194 Clear Undo Data,
- \*17) 0-199 Input CH Library Number (0 Request Only),
- \*18) 0-199 Output CH Library Number (0 Request Only),
- \*19) 512-527 Premium Rack 1A, 1B, 2A, ... 8A, 8B
- \*20) 0-100 Each Premium Effect Library Number (0 Request Only)
- \*21) 1536-1607 Input 1-64 (for Dynamics2),
- \*22) 1608-1623 STIN 1L-8R (for Dynamics2),
- \*23) 0-10 Dante Input Patch Library Number (0 Request Only)

Data is lost when you write to the preset library.

The unique header (Model ID) identifies whether the device is a QL series.

To calculate the check sum, add the bytes starting with the byte after BYTE COUNT (LOW) and ending with the byte before CHECK SUM, take the binary complement, and set bit 7 to 0.

CHECK SUM = (-sum)&0x7F

Bulk Dumps can be received at any time, and can be transmitted at any time when a Bulk Dump Request is received.

A Bulk Dump is transmitted on the [Rx CH] channel in response to a Bulk Dump Request.

In the data portion, seven words of 8-bit data are converted into eight words of 7-bit data.





### 4.2.3 Module Name

Module Name	
Scene	"SCENE__"
Input EQ	"INEQ__"
Output EQ	"OUTEQ__"
Dynamics	"DYNA__"
Input CH	"INCHNNL_"
Output CH	"OUTCHNNL_"
GEQ	"GEQ__"
Effect	"EFFECT__"
Portico5033	"P5033__"
Portico5043	"P5043__"
U76	"U76__"
Opt-2A	"OPT-2A__"
EQP-1A	"EQ-1A__"
Dynamic EQ	"DYNAEQ__"
Dante Input Patch	"DANTEIN_"

Function		Number	Channel*1)	tx/rx
"LibStr__"	SCENE	1-300	*5)	tx/rx
	INPUT EQ LIB	41-199	*1)	tx/rx
	OUTPUT EQ LIB	4-199	*2) *3) *4)	tx/rx
	Dynamics LIB	42-199	*1) *2) *3) *4) *8)	tx/rx
	INPUT CH LIB	1-199	*1)	tx/rx
	OUTPUT CH LIB	1-199	*2) *3) *4)	tx/rx
	GEQ LIB	1-199	*6)	tx/rx
	EFFECT LIB	28-199	*7)	tx/rx
	Premium Effect LIB	1-100	*9)	tx/rx
	Dante Input Patch LIB	1-10	*5)	tx/rx
"LibUnStr"	SCENE	1-300	0	tx
	INPUT EQ LIB	41-199	0	tx
	OUTPUT EQ LIB	4-199	0	tx
	Dynamics LIB	42-199	0	tx
	INPUT CH LIB	1-199	0	tx
	OUTPUT CH LIB	1-199	0	tx
	GEQ LIB	1-199	0	tx
	EFFECT LIB	28-199	0	tx
	Premium Effect LIB	1-100	0	tx
	Dante Input Patch LIB	1-10	0	tx
"LibRcl__"	SCENE	0-300	*5)	tx/rx
	INPUT EQ LIB	1-199	*1)	tx/rx
	OUTPUT EQ LIB	1-199	*2) *3) *4)	tx/rx
	Dynamics LIB	1-199	*1) *2) *3) *4) *8)	tx/rx
	INPUT CH LIB	0-199	*1)	tx/rx
	OUTPUT CH LIB	0-199	*2) *3) *4)	tx/rx
	GEQ LIB	0-199	*6)	tx/rx
	EFFECT LIB	1-199	*7)	tx/rx
	Premium Effect LIB	0-100	*9)	tx/rx
	Dante Input Patch LIB	0-10	*5)	tx/rx
"LibUnRcl"	SCENE	0	*5)	tx
	INPUT EQ LIB	0	*1)	tx
	OUTPUT EQ LIB	0	*2) *3) *4)	tx

Function		Number	Channel*1)	tx/rx
	Dynamics LIB	0	*1) *2) *3) *4) *8)	tx
	INPUT CH LIB	0	*1)	tx
	OUTPUT CH LIB	0	*2) *3) *4)	tx
	GEQ LIB	0	*6)	tx
	EFFECT LIB	0	*7)	tx
	Premium Effect LIB	0	*9)	tx
	Dante Input Patch LIB	0	*5)	tx
"LibStrUd"	SCENE	0	0	
"LibRclUd"	SCENE	0	0	

- \*1) 0: CH1 – 63: CH64  
72: ST IN 1L – 79: ST IN 4R
- \*2) 256: MIX 1 – 271: MIX 16
- \*3) 512: MATRIX 1 – 519: MATRIX 8
- \*4) 1024: STEREO L – 1026: STEREO C
- \*5) 512: will be used if the recalling or storing data is only one.
- \*6) 0: GEQ1A, 1: GEQ1B, 2: GEQ2A, ... 36: GEQ19A, 37:GEQ19B  
38: EFFECT GEQ1A, 39: EFFECT GEQ1B,  
40: EFFECT GEQ2A, ... 52: EFFECT GEQ8A, 53: EFFECT GEQ8B
- \*7) 0: Effect1- 7: Effect8
- \*8) 1280: CH1 – 1343: CH64  
1352: ST IN 1L – 1367: ST IN 8R
- \*9) 0: Premium Rack 1A, 1: Premium Rack 1B,  
2: Premium Rack 2A, ... 14: Premium Rack 8A, 15: Premium Rack 8B

## 4.3 FUNCTION CALL – LIBRARY EDIT –

### 4.3.1 Format (PARAMETER CHANGE)

#### Reception

Data will be received when [PARAMETER CHANGE Rx] is on and the Device number of both [Rx CH] and SUB STATUS match.  
The data will be echoed when [PARAMETER CHANGE ECHO] is on.  
The corresponding memory/library will be changed immediately the data is received.

#### Transmission

PARAMETER CHANGE will be sent in reply to Request.  
If [PARAMETER CHANGE ECHO] is on, the message will be sent as it is.

STATUS	11110000	F0	System exclusive message
ID No.	01000011	43	Manufacturer's ID number (YAMAHA)
SUB STATUS	0001nnnn	1n	n=0-15 (Device number=MIDI Channel)
GROUP ID	00111110	3E	Digital mixer
MODEL ID	00010010	19	QL Series
DATA CATEGORY	00000000	00	OTHER DATA
FUNCTION NAME	01001100	"L"	(ASCII CODE)
	01101001	"i"	(ASCII CODE)
	01100010	"b"	(ASCII CODE)
	0fffffff	ff	(ASCII CODE)
	0ffffff	ff	(ASCII CODE)
	0ffffff	ff	(ASCII CODE)
	0ffffff	ff	(ASCII CODE)
	0ffffff	ff	(ASCII CODE)
	0ffffff	ff	(ASCII CODE)
MODULE NAME	0mmmmmm	mm	(ASCII CODE)
	0mmmmmm	mm	(ASCII CODE)
	0mmmmmm	mm	(ASCII CODE)

	0mmmmmm	mm	(ASCII CODE)
	0mmmmmm	mm	(ASCII CODE)
	0mmmmmm	mm	(ASCII CODE)
	0mmmmmm	mm	(ASCII CODE)
	0mmmmmm	mm	(ASCII CODE)
DATA	0ssssss	sh	number -source start High
	0ssssss	sl	number -source start Low
	0eeeeeee	eh	number -source end High
	0eeeeeee	el	number -source end Low
	0ddddddd	dh	number -destination start High
	0ddddddd	dl	number -destination to start Low
EOX	11110111	F7	End of exclusive

### 4.3.2 Function Name

Function Name	
Copy	"LibCpy__"
Paste	"LibPst__"
Clear	"LibClr__"
Cut	"LibCut__"
Insert	"LibIns__"
Edit Undo	"LibEdtUd"

### 4.3.3 Module Name

Module Name		Function
SCENE LIB	"SCENE__"	Copy, Paste, Clear, Cut, Insert, EditUndo
INPUT EQ LIB	"INEQ__"	Clear Only
OUTPUT EQ LIB	"OUTEQ__"	Clear Only
Dynamics LIB	"DYNA__"	Clear Only
INPUT CH LIB	"INCHNNL_"	Clear Only
OUTPUT CH LIB	"OUTCHNNL_"	Clear Only
GEQ LIB	"GEQ__"	Clear Only
EFFECT LIB	"EFFECT__"	Clear Only
Portico5033 LIB	"P5033__"	Clear Only
Portico5043 LIB	"P5043__"	Clear Only
U76 LIB	"U76__"	Clear Only
Opt-2A LIB	"OPT-2A__"	Clear Only
EQP-1A LIB	"EQ-1A__"	Clear Only
DynamicEQ LIB	"DYNAEQ__"	Clear Only
Dante Input Patch LIB	"DANTEIN_"	Clear Only





## 4.8 FUNCTION CALL – CHANNEL –

### 4.8.1 Pair ON/OFF Trigger Format (PARAMETER CHANGE)

#### Reception

Data will be received when [PARAMETER CHANGE Rx] is on and the Device number of both [Rx CH] and SUB STATUS match.

The data will be echoed when [PARAMETER CHANGE ECHO] is on.

```

STATUS      11110000 F0 System exclusive message
ID No.      01000011 43 Manufacture's ID number (YAMAHA)
SUB STATUS  0001nnnn 1n n=0-15 (Device number=MIDI Channel)
GROUP ID    00111110 3E Digital mixer
MODEL ID    00010010 19 QL Series
DATA CATEGORY 00000000 00 OTHER DATA
FUNCTION NAME 01000011 "C"
              01101000 "h"
              01101100 "l"
              01010000 "P"
              01101001 "i"
              01110010 "r"
              01000011 "C"
              01110000 "p"
MODULE NAME 0mmmmmmmm mm (ASCII CODE)
              0mmmmmmmm mm (ASCII CODE)
              0mmmmmmmm mm (ASCII CODE)
              0mmmmmmmm mm (ASCII CODE)
              0mmmmmmmm mm (ASCII CODE)
              0mmmmmmmm mm (ASCII CODE)
              0mmmmmmmm mm (ASCII CODE)
              0mmmmmmmm mm (ASCII CODE)
              0mmmmmmmm mm (ASCII CODE)
DATA        0sssssss sh Source Channel Number H *1)
              0sssssss sl Source Channel Number L *1)
              0ddddddd dh Destination Channel Number H *1)
              0ddddddd dl Destination Channel Number L *1)
EOX         11110111 F7 End of exclusive
    
```

### 4.8.2 Module Name

Module Name	
Pair On (with Copy)	"PAIRONCP"
Pair On (with Reset Both)	"PAIRONRS"
Pair Off	"PAIROFF_"

\*1) 0 : CH1 – 63: CH64  
 256 : MIX 1 – 271: MIX 16  
 512 : MATRIX 1 – 519: MATRIX 8

## 4.9 LEVEL METER DATA

### 4.9.1 Format (PARAMETER CHANGE)

When transmission is enabled by receiving Request for Level Meter, the corresponding metering data will be sent in every 50 millisecond for 10 seconds. If metering information is expected to be continuously sent, Request is needed to be sent in at least every 10 seconds.

#### Reception

The data will be echoed when [PARAMETER CHANGE ECHO] is on.

#### Transmission

When transmission is enabled by receiving Request, the corresponding metering data will be sent in constant interval for a given period of time (The interval and time will vary depending on devices).

When rebooted or port setting is changed, the transmission will be disabled.

When [PARAMETER CHANGE ECHO] is on, the message will be sent as it is.

```

STATUS      11110000 F0 System exclusive message
ID No.      01000011 43 Manufacture's ID number (YAMAHA)
SUB STATUS  0001nnnn 1n n=0-15 (Device number=MIDI Channel)
GROUP ID    00111110 3E Digital mixer
MODEL ID    00010010 19 QL Series
DATA CATEGORY 00100001 21 REMOTE LEVEL METER
DATA        0mmmmmmmm mm ADDRESS UL
              0mmmmmmmm mm ADDRESS LU
              0mmmmmmmm mm ADDRESS LL
              0ddddddd dd Data1
              :
              :
EOX         11110111 F7 End of exclusive
    
```

### 4.9.2 Format (PARAMETER REQUEST)

#### Reception

Data will be received when [PARAMETER CHANGE Rx] is on and the Device number of both [Rx CH] and SUB STATUS match.

The data will be echoed when [PARAMETER CHANGE ECHO] is on.

The corresponding metering data will be sent via [Rx CH] in constant interval for a given period of time (The interval and time will vary depending on devices).

When Address UL = 0x7F is received, all metering data transmission will be immediately stopped [disabled].

#### Transmission

When [PARAMETER CHANGE ECHO] is on, the message will be sent as it is.

```

STATUS      11110000 F0 System exclusive message
ID No.      01000011 43 Manufacture's ID number (YAMAHA)
SUB STATUS  0011nnnn 3n n=0-15 (Device number=MIDI Channel)
GROUP ID    00111110 3E Digital mixer
MODEL ID    00010010 19 QL Series
DATA CATEGORY 00100001 21 REMOTE LEVEL METER
DATA        0mmmmmmmm mm ADDRESS UL
              0mmmmmmmm mm ADDRESS LU
              0mmmmmmmm mm ADDRESS LL
              0ccccccc ch Count H
              0ccccccc cl Count L
EOX         11110111 F7 End of exclusive
    
```

# Input/Output Specifications

## Analog input specifications

Input Connectors	Gain	Input Impedance	Source Impedance	Input Level			Connector
				Sensitivity*1	Defined Level	Maximum Non-Clip Level	
INPUT 1-32*6	+66dB	7.5 kΩ	50-600 Ω Mics & 600 Ω Lines	-82dBu (61.6μV)	-62dBu (0.616mV)	-42dBu (6.16mV)	XLR-3-31 type (Balanced)*2
	-6dB			-10dBu (245mV)	+10dBu (2.45V)	+30dBu (24.5V)	

- \*1. The sensitivity is the input level required for output at +4dBu (1.23V) or at the defined level when all the faders and level controllers are set to the maximum value.
- \*2. XLR-3-31 connectors are balanced jacks (1=GND, 2=HOT, 3=COLD).
- \*3. 0dBu=0.775 Vrms for all specifications.
- \*4. All the AD converters use 24-bit linear/128-times oversampling.
- \*5. The INPUT connectors have +48V DC (phantom power) jacks, each of which can be turned on/off individually from the console software.
- \*6. QL1: INPUT1-16

## Analog output specifications

Output Connectors	Output Impedance	Load Impedance	Maximum Output Level SW*5	Output Level		Connector
				Defined Level	Maximum Non-Clip Level	
OMNI OUT 1-16*7	75 Ω	600 Ω Lines	+24dB (default)	+4dBu (1.23V)	+24dBu (12.3V)	XLR-3-32 type (Balanced)*1
			+18dB	-2dBu (616mV)	+18dBu (6.16V)	
PHONES	15 Ω	8 Ω Phones	-	75mW*6	150mW	Stereo Phone Jack (TRS) (Unbalanced)*2
		40 Ω Phones	-	65mW*6	150mW	

- \*1. XLR-3-32 connectors are balanced jacks (1=GND, 2=HOT, 3=COLD).
- \*2. The PHONES connectors for stereo headphones are balanced jacks (Tip=LEFT, Ring=RIGHT, Sleeve= GND).
- \*3. 0 dBu=0.775 Vrms for all specifications.
- \*4. All the DA converters use 24-bit linear/128-times oversampling.
- \*5. The console has an internal switch for toggling the maximum output level.
- \*6. This is a value measured with the PHONES LEVEL knob set to 10 dB below the maximum position.
- \*7. QL1: OMNI OUT 1-8

## Digital input/output specifications

Connectors	Format	Data Length	Level	Audio	Connector
Primary/Secondary	Dante	24bit or 32bit	1000Base-T	64ch Input/64ch Output @48kHz*1	etherCON CAT5e

\*1. QL1: 32ch Input/32ch Output@48kHz

## Digital output specifications

Connectors	Format	Data Length	Level	Connector	
DIGITAL OUT	AES/EBU	AES/EBU Professional Use	24 bit	RS422	XLR-3-32 type (Balanced)*1

\*1. XLR-3-32 connectors are balanced jacks (1=GND, 2=HOT, 3=COLD).

## I/O SLOT (1-2) specifications

A Mini-YGDAI card can be inserted into slots 1-2.  
Only slot 1 supports serial interfaces.

## Control I/O specifications

Connectors	Format	Level	Connector
MIDI	IN	MIDI	DIN Connector 5P
	OUT	MIDI	DIN Connector 5P
WORD CLOCK	IN	-	TTL/75 Ω terminated
	OUT	-	TTL/75 Ω
GPI (SIN/SOUT)	-	-	D Sub Connector 15P (Female)*1
NETWORK	IEEE802.3	10BASE-T/100Base-TX	RJ-45
LAMP (QL5: x2, QL1: x1)	-	0V-12V	XLR-4-31 type*2
USB HOST	USB 2.0	-	USB A Connector (Female)

- \*1. Input pin: TTL level, w/ internal pull-up (47kΩ)  
Output pin: Open drain output (Vmax=12V, maximum sink current/pin=75mA)  
Power supply pin: Output voltage Vp=5V, Max. output current Imax=300mA
- \*2. 4 pin=+12V, 3 pin=GND, Lamp nominal power: 5W, Brightness (voltage) can be adjusted from the software.

## Electrical characteristics

All faders are nominal when measured. Output impedance of signal generator: 150 ohms

### Frequency Response.

Fs= 48 kHz @20 Hz–20 kHz, referenced to the nominal output level @1 kHz

Input	Output	RL	Conditions	Min.	Typ.	Max.	Unit
INPUT 1-32*1	OMNI OUT 1-16*2	600 Ω	GAIN: +66dB	-1.5	0.0	0.5	dB
	PHONES	8 Ω		-3.0	0.0	0.5	

\*1. QL1: INPUT 1-16

\*2. QL1: OMNI OUT 1-8

### Total Harmonic Distortion.

Fs= 48 kHz

Input	Output	RL	Conditions	Min.	Typ.	Max.	Unit
INPUT 1-32*1	OMNI OUT 1-16*2	600 Ω	+4 dBu @20 Hz–20 kHz, GAIN: +66dB			0.1	%
			+4 dBu @20 Hz–20 kHz, GAIN: -6dB			0.05	
Internal OSC	OMNI OUT 1-16*2	600 Ω	Full Scale Output @1 kHz			0.02	
	PHONES	8 Ω	Full Scale Output @1 kHz, PHONES Level Control: Max.			0.2	

\*1. QL1: INPUT 1-16

\*2. QL1: OMNI OUT 1-8

\*3. Total Harmonic Distortion is measured with a 18 dB/octave filter @80 kHz

### Hum & Noise.

Fs= 48 kHz, EIN= Equivalent Input Noise

Input	Output	RL	Conditions	Min.	Typ.	Max.	Unit
INPUT 1-32*1	OMNI OUT 1-16*2	600 Ω	Rs= 150 Ω, GAIN: +66dB Master fader at nominal level and one Ch fader at nominal level.		-128 EIN		dBu
			Rs= 150 Ω, GAIN: -6dB Master fader at nominal level and one Ch fader at nominal level.		-84	-80	
All INPUTs	OMNI OUT 1-16*2	600 Ω	Rs= 150 Ω, GAIN: -6dB Master fader at nominal level and all INPUT 1-32*1 in faders at nominal level.			QL5: -64 QL1: -67	
—	OMNI OUT 1-16*2	600 Ω	Residual Output Noise, ST Master Off			-88	
—	PHONES	8 Ω	Residual Output Noise, PHONES Level Control Min.			-88	

\*1. QL1: INPUT 1-16

\*2. QL1: OMNI OUT 1-8

\*3. Hum & Noise are measured with A-weight filter.

### Dynamic Range.

Fs= 48 kHz

Input	Output	RL	Conditions	Min.	Typ.	Max.	Unit
INPUT 1-32*1	OMNI OUT 1-16*2	600 Ω	AD + DA, GAIN: -6dB		108		dB
—	OMNI OUT 1-16*2	600 Ω	DA Converter		112		dB

\*1. QL1: INPUT 1-16

\*2. QL1: OMNI OUT 1-8

\*3. Dynamic Range are measured with A-weight filter.

### Sampling Frequency

Parameter	Conditions	Min.	Typ.	Max.	Unit	
External Clock	Frequency Range Fs= 44.1 kHz Fs= 45.9375 kHz (44.1 kHz +4.1667%) Fs= 44.1441 kHz (44.1 kHz +0.1%) Fs= 44.0559 kHz (44.1 kHz -0.1%) Fs= 42.336 kHz (44.1 kHz -4.0%)	-200		+200	ppm	
	Fs= 48 kHz Fs= 50 kHz (48 kHz +4.1667%) Fs= 48.048 kHz (48 kHz +0.1%) Fs= 47.952 kHz (48 kHz -0.1%) Fs= 46.080 kHz (48 kHz -4.0%)					
Jitter of PLL	DIGITAL IN Fs= 44.1 kHz DIGITAL IN Fs= 48 kHz			10	ns	
Internal Clock	Frequency			44.1	kHz	
				48		
	Accuracy	Word Clock : Int 44.1 kHz	-50		+50	ppm
		Word Clock : Int 48 kHz				
Jitter	Word Clock : Int 44.1 kHz			4.429	ns	
	Word Clock : Int 48 kHz			4.069		



# Mixer Basic Parameters

## Libraries

Name	Number	Total
Scene Memory	Preset 1 + User 300	301
Input CH Library	Preset 1 + User 199	200
Output CH Library	Preset 1 + User 199	200
Input EQ Library	Preset 40 + User 159	199
Output EQ Library	Preset 3 + User 196	199
Dynamics Library	Preset 41 + User 158	199
Effect Library	Preset 27 + User 172	199
GEQ Library	Preset 1 + User 199	200
Premium Rack Library		
Portico5033		
Portico5043		
U76	Preset 1 + User 199	200
Opt-2A		
EQ-1A		
Dynamic EQ		
Dante Input Patch Library	Preset 1 + User 10	11

## Input Function

Function	Parameter
Phase	Normal/Reverse
Digital Gain	-96 dB to +24 dB
HPF	Slope= -12dB/Oct, -6dB/Oct Frequency= 20 Hz to 600 Hz
Attenuator	-96 dB to 0 dB
4 Band Equalizer	Frequency= 20 Hz to 20 kHz
	Gain= -18 dB to +18 dB
	Q= 0.10 to 10.0
	Low Shelving (Low Band)
	High Shelving, LPF (High Band)
Type I/Type II	
Insert	Insert Point: Pre EQ/Pre Fader/Post On
Direct Out	Direct Out Point: Pre HPF/Pre EQ/Pre Fader/Post On

Function	Parameter
Dynamics 1	Type: Gate/Ducking/Comp/Expander
	Threshold=Gate: -72 dB to 0 dB Others: -54 dB to 0 dB
	Ratio= 1:1 to ∞:1
	Attack= 0 msec to 120 msec
	Hold= 48 kHz: 0.02 msec to 1.96 sec 44.1 kHz: 0.02 msec to 2.13 sec
	Decay= 48 kHz: 5 msec to 42.3 sec 44.1 kHz: 6 msec to 46.1 sec
	Release= 48 kHz: 5 msec to 42.3 sec 44.1 kHz: 6 msec to 46.1 sec
	Range= Gate: -∞ dB to 0 dB Ducking: -70 dB to 0 dB
	Gain= 0.0 dB to +8dB
	Knee= Hard to 5 (soft)
Dynamics 2	Type: Comp/De-Esser/Compander H/Compander S
	Threshold= -54 dB to 0 dB
	Ratio= 1:1 to ∞:1 Compander: 1:1 to 20:1
	Attack= 0 msec to 120 msec
	Release= 48 kHz: 5 msec to 42.3 sec 44.1 kHz: 6 msec to 46.1 sec
	Gain= -18 dB to 0 dB, 0 dB to +18 dB
	Knee= Hard to 5 (soft)
	Key In: Self Pre EQ/Self Post EQ/Mix Out1 3-16 Ch1-STIN8R (8ch block)
	Width= 1 dB to 90 dB
	Frequency= 1.0 KHz to 12.5KHz
Fader	TYPE= HPF, BPF
	Q= 0.10 to 10.0
	Level: 1024 steps, ∞, -138 dB to +10 dB
	On/Off
	Position L63 to R63 Pan Mode: Pan/Balance
	16 Groups
	8 Groups
	24 sends
	Fix/Variable can be set each two mixes
	Mix Send Point: Pre EQ/Pre Fader/Post On
Mix Send	Level: 1024 steps, ∞, -138 dB to +10 dB
	8 Sends
Matrix Send	Matrix Send Point: Pre EQ/Pre Fader/Post On
	Level: 1024 steps, ∞, -138 dB to +10 dB
LCR Pan	CSR= 0% to 100%
DELAY	0 ms to 1000 msec

## Output Function

Function	Parameter
Attenuator	-96 dB to 0 dB
4 Band Equalizer	Frequency= 20 Hz to 20 kHz
	Gain= -18 dB to +18 dB
	Q= 0.10 to 10.0
	Low Shelving (Low Band)
	High Shelving, LPF (High Band)
Type I/Type II	
Insert	Insert Point: Pre EQ/Pre Fader/Post On
Dynamics 1	Type: Comp/Expander/Compander H/Compander S
	Threshold= -54 dB to 0 dB
	Ratio= 1:1 to ∞:1 Compander: 1:1 to 20:1
	Attack= 0 msec to 120 msec
	Release= 48 kHz: 5 msec to 42.3 sec 44.1 kHz: 6 msec to 46.1 sec
	Gain= -18 dB to 0 dB, 0 dB to +18 dB
	Knee= Hard to 5 (soft)
	Key In: Self Pre EQ/Self Post EQ/Mix Out1 3-16/ MTRX1-8/STIN LR/MONO(C) (8ch block)
	Width= 1 dB to 90 dB
Fader	Level: 1024 steps, ∞, -138 dB to +10 dB
On	On/Off
Pan/Balance	Position L63 to R63
Mute Group	8 Groups
Mix to Matrix	Matrix Send Point: Pre Fader/Post On
Stereo to Matrix	Level: 1024 steps, ∞, -138 dB to +10 dB
Oscillator	Level= 0 to -96dB (1 dB step) On/Off= Software control

## Output Port

Function	Parameter
Out Port Delay	0 msec to 1000 msec
Out Port Phase	Normal/Reverse
Gain	-96 to +24 dB

## Processor

Function	Parameter
GEQ	31 bands x 8(16) or 15 bands x 16(32) or 16 ch Automixer x1 or 8 ch Automixer x1
Effects	Stereo In/Stereo Out multi effector x 8 systems
Premium Rack Parameter	Stereo(Dual) In/Stereo(Dual) Out Premium Rack x 8 systems

# Pin Assignment Chart

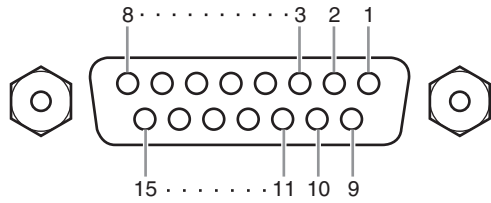

## GPI

Pin	Signal Name	Pin	Signal Name
1	GPO1	9	GPO2
2	GPO3	10	GPO4
3	GPO5	11	GND
4	GND	12	GND
5	+5V	13	+5V
6	GPI1	14	GPI2
7	GPI3	15	GPI4
8	GPI5		

Model: QL5/QL1

## MIDI Implementation Chart

Version: 1.0

Function...	Transmitted	Recognized	Remarks
Basic Channel Default Changed	1-16 1-16	1-16 1-16	Memorized
Mode Default Messages Altered	X X *****	1, 3 X X	Memorized
Note Number True Voice	0-127 X	0-127 X	
Velocity Note On Note Off	0 9nH, v=0,127 X	0 9nH, v=1-127 O	Effect Control
After Touch Key's Ch's	X X	X X	
Pitch Bend	X	X	
Control Change 0,32 6,38 98,99 1-31,33-95, 102-119	O O O O	O O O O	Bank Select Data Entry NRPN LSB,MSB Assignable Cntrl
Prog Change :True#	O 0-127 *****	O 0-127 O 0-300	Assignable
System Exclusive	O *1	O *1,*2	
Common :Song Pos. :Song Sel. :Tune	X X X	X O X	Recorder Control
System Real Time :Clock :Commands	X X	O X	Effect Control
Aux Messages :All Sound Off :Reset All Cntrls :Local ON/OFF :All Notes OFF :Active Sense :Reset	X X X X X X	X X X X O O	
Notes	*1 Bulk Dump/Request and Parameter Change/Request. *2 MMC		

Mode 1: OMNI ON, POLY  
Mode 3: OMNI OFF, POLYMode 2: OMNI ON, MONO  
Mode 4: OMNI OFF, MONOO: Yes  
X: No



Yamaha Pro Audio Global Web Site  
<http://www.yamahaproaudio.com/>  
Yamaha Manual Library  
<http://www.yamaha.co.jp/manual/>

C.S.G., PA Development Division  
© 2014 Yamaha Corporation

402MA-A0