

ROXIE2 - 1166-2 WW

ULTRA COMPACT - LED 300 W



- **Type:** Followspot
- **Source:** LED 300 W
- **Optics:** 10.5° to 22.5° zoom
- **Colour temperature:** Warm white

Followspot

The little LED wonder with the power punch

Roxie is Robert Juliat's first LED followspot. The compact 300W spot is all about efficiency. It fits in the smallest of spaces and is the ideal energy-efficient solution for all those venues where running costs need to be significantly reduced. Roxie delivers an output comparable to most of the 575W discharge followspot available on the market. No heat, no lamp change, less maintenance. Smooth electronic dimming is available as standard, either locally via the rotary dimmer knob or remotely via DMX.

Features

- **Fully closing iris:** removable for fast, easy replacement
- **Universal gobo holder:** "A" size glass and metal gobo
- **Local control:** light intensity adjustment through built-in potentiometer
- **Internal glass filter holder:** long term use of durable coloured, dichroic or textured glass
- **Colour changer:** 6-way, 'push/pull' colour changer system for simultaneous use of multiple filters
- **Remote setup:** all parameters can be adjusted by RDM protocol
- **Adjustable response time:** choice of fast or slow dimming for tungsten-like simulation
- **DMX:** 8 or 16 bit dimming and strobe function
- **Local setup:** dMX address and mode, dimming curve and response time through 4-button display with automatic light switch-off
- **Control:** local, DMX, wireless DMX (option)
- **Easy focus reference:** graduated scale on side of the unit; fast and easy refocusing

Optical

- **SX optical system:** double condenser optics for exceptional optical quality
- **Coated double condenser optical system:** ensures optimal light transmission
- **Variable zoom optics:** sharp focus at every beam angle. Independent control of image size and focus.
- **Electronic dimmer:** dimming without clipping or cut-out at low intensity levels; high quality smoothing
- **No colour shift:** colour temperature remains the same when dimming

Construction

- **Made in France :** fully manufactured in Robert Juliat premises retaining complete control over all aspects of quality
- **PSU:** built-in electronic flicker-free power supply for easy, plug-and-play installation
- **Power connectors:** neutriK® powerCON TRUE1 TOP IN and OUT connectors for daisy chaining
- **Silent-running cooling fans:** ideal for TV studios and opera houses
- **Electronic thermal management system:** ensures maximum performance of the system without any risk of overheating
- **Bodywork:** strong sheet metal construction for durability
- **Moving parts:** smooth at all times, even when hot
- **Captive knobs and handles:** additional security when working at height or in transit
- **Easy access to all parts:** easy cleaning and maintenance

Picture:1166

DSEN298_1166-2_WW - 23/03/2022

Robert Juliat reserves the right to change or alter any of the items detailed on this page, to increase or improve manufacturing techniques without prior notice.

Robert Juliat S.A.S., 32 rue de Beaumont, 60530 Fresnoy-en-Thelle - France
Telephone : +33 (0)3 44 26 51 89 - fax : +33 (0)3 44 26 90 79 - info@robertjuliat.fr
www.robertjuliat.com



ROBERT JULIAT

Source

- **Lamp type:** LED
- **Power:** 247 W

LED specifications	Power *	Lumen output*	Colour temperature*	Life*	CRI* (min)
SUHD60 V3 WW (RJ / Osram)	247 W	22 575 lm	3000K	100 000 h	92

Life data following L70B50 standard - (*) manufacturer's data

Optics

Characteristics

- **Type:** Zoom
- **Beam range:** 10.5° to 22.5°
- **Focal length:** 184 - 374 mm

Gel filter

- **Shape:** Circle
- **Standard size:** 165 mm (6.5 in)

Gobo

- **Size:** A
- **Material:** Metal
Glass



Photometrics (Photometrics report(s) available at the end of the document)

with SUHD60 V3 WW (RJ / Osram) source

• Optics @ 10.5°

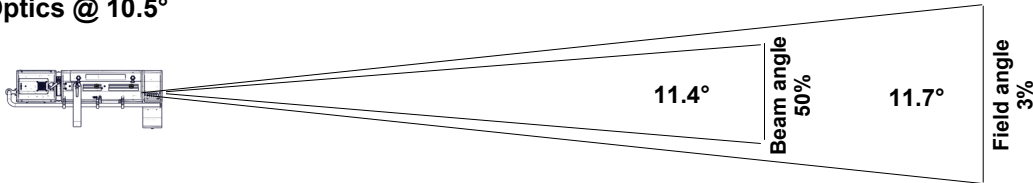

Beam intensity
215 100 cd

Field lumens
5 280 lm

Efficacy
19 lm/W

CCT
3 140 K

Distance	5 m	10 m	15 m	20 m	25 m	30 m
Diameter	1 m	2 m	3.1 m	4.1 m	5.1 m	6.1 m
Illumination	8 700 lux	2 200 lux	960 lux	540 lux	350 lux	240 lux
Distance	15 ft	35 ft	50 ft	65 ft	80 ft	100 ft
Diameter	3.1 ft	7.2 ft	10.2 ft	13.3 ft	16.4 ft	20.5 ft
Illumination	960 fc	180 fc	90 fc	55 fc	34 fc	22 fc

• Optics @ 22.5°

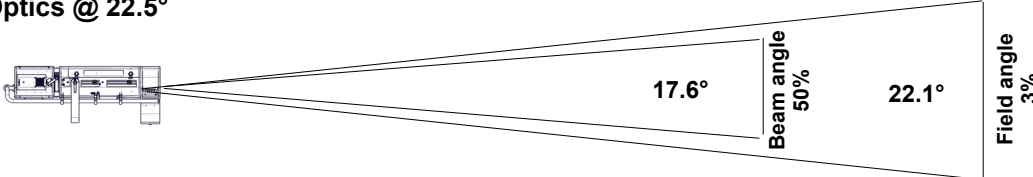

Beam intensity
90 000 cd

Field lumens
6 340 lm

Efficacy
23 lm/W

CCT
3 160 K

Distance	5 m	10 m	15 m	20 m	25 m	30 m
Diameter	2 m	3.9 m	5.9 m	7.8 m	9.8 m	11.7 m
Illumination	3 650 lux	910 lux	410 lux	230 lux	150 lux	105 lux
Distance	15 ft	35 ft	50 ft	65 ft	80 ft	100 ft
Diameter	5.9 ft	13.7 ft	19.5 ft	25.4 ft	31.2 ft	39.1 ft
Illumination	410 fc	75 fc	37 fc	22 fc	15 fc	10 fc

Remote control

- **Data protocol:** USITT DMX512-A
RDM

- **Data IN connector:** 5 pins XLR male
- **Data OUT connector:** 5 pins XLR female



• DMX chart:

Mode 1 (1 channels)

Dimmer

Mode 2 (4 channels)

Dimmer
Dimmer fine
-
Strobe

Mode 3 (5 channels)

Dimmer
Dimmer fine
-
Strobe
Dimmer master

Dimensions and weight

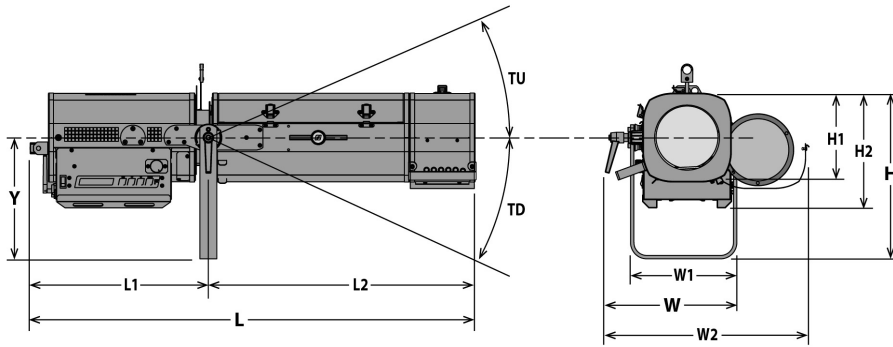

Weight: 20.5 kg (45.1 lbs)

Height	Length	Width	Yoke	Tilt
H= 387 mm (15.2 in)	L= 1045 mm (41.1 in)	W= 321 mm (12.6 in)	Y= 283 mm (11.1 in)	TU= 51°
H1= 208 mm (8.2 in)	L1= 418 mm (16.5 in)	W1= 249 mm (9.8 in)		TD= 65°
H2= 268 mm (10.6 in)	L2= 627 mm (24.7 in)	W2= 490 mm (19.3 in)		

Shipping

- **Weight :** 23.6 kg (51.9 lbs)
- **Volume :** .17 m³ (6 ft³)

Installation

- **Minimum distance to illuminated surface:** 0.6 m (1.8 ft)
- **Operating position:**



Construction

- **Housing:** Steel sheet - Aluminium
- **Colour:** Black
- **Cooling:** Low noise variable fan
- **Maximum ambient temperature (Ta):** 40°C (104°F)
- **Maximum case temperature (Tc):** 70°C (158°F)
- **Total heat dissipation:** 976 BTU/h
- **Ingress Protection (IP) rating:** IP20

Electrical compatibility

- 220/230 V - 50 Hz
- 245 V - 50 Hz
- 110/120 V - 60 Hz
- 208 V - 60 Hz
- 220/230 V - 60 Hz
- 100 V - 50 Hz
- 100 V - 60 Hz
- Selector: automatic detection

Power input



- **Type:** removable power cord with Neutrik powerCON TRUE1 TOP connector (included)
- **Cable:** H07RNF 3G1.5
- **Length:** 3 m (9.8 ft)
- **Power connector:** CEE 7/7 (2P+E NF/Schuko)

Power consumption

Voltage	Frequency	Current	Power	Power factor
230 V	50 Hz	1.3 A	286 W	0.97
120 V	60 Hz	2.5 A	291 W	0.99
100 V	60 Hz	3 A	295 W	0.99

Power Supply Unit

- **PSU:** Internal - Electronic PSU - Flicker free with PFC
- **Control:** Local / DMX
- **Protection:** Mains: 4A 1P1D breaker - UL /
- **Power thru:** Neutrik powerCON TRUE1 TOP - Maximum of 10 units (230 V) / 5 units (120 V)

Warranty

- **Fixture: 3 years - Source: 5 years**
See General Sales Condition on website

Approvals





Acoustics

- **Noise level:** < 24,9 dB(A)













Model

1166-2 WW	LED 300 W Followspot - 1166-2 WW Roxie2 - Warm White - 10.5/22.5°
------------------	---

Options

PCP1716A	16A blue 2P+E 6h IEC60309 power connector	
W-DMX/Z	W-DMX wireless DMX	
FC1124	Flight-case for Ultra Compact range / GT stand - Dim: 1210x600x560mm - Weight: 35 Kg	

Accessories

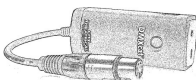
IS750	Full closing iris with holder - Poids: 0.35 Kg 1 included	
PF1114	Ø165 mm metal filter holder 6 included	
SGUX	Universal "A" size gobo-holder (metal, glass, frosted glass) 1 included	
M165TP	6 ways "push/pull" colour changer - Poids: 2.09 Kg 1 included	
GT1000	Tripod stand - SWL: 40 Kg - max. height: 1550 mm - Poids: 9.27 Kg	
GT800	Tripod stand - SWL: 40 Kg - max. height: 1550 mm - Poids: 7.98 Kg	
T1000	TV spigot with followspots swivel head - Poids: 1.82 Kg	
T4000	Followspot mount for Ø50mm pipe (suspension or overhead) - SWL= 100 Kg - Poids: 4.88 Kg	
CAV600A	Double slot front cassette for 180x180mm accessories - Poids: 0.43 Kg	
VD120	120x120mm frosted glass	
Kit TELRAD	Telrad followspot sight with raiser and universal mounting kit - Poids: 1.23 Kg	
SDUP	Followspot cue sheet holder with universal mounting kit	
DMXcat	Bluetooth DMX/RDM Multifunction test tool - City Theatrical DMXcat®	

FC1124/S

Flight-case for Ultra Compact range / GT stand - Poids: 35 Kg



W/GT800

Set of 3 wheels for GT800/1000 stand - Poids: 2.33 Kg



• Optics @ 10,5°

Field lumens	Beam lumens	Efficacy	Beam intensity	CCT	Delta uv
5 280 Lm	5 150 Lm	19 Lm/W	215 100 Cd	3 140 K	

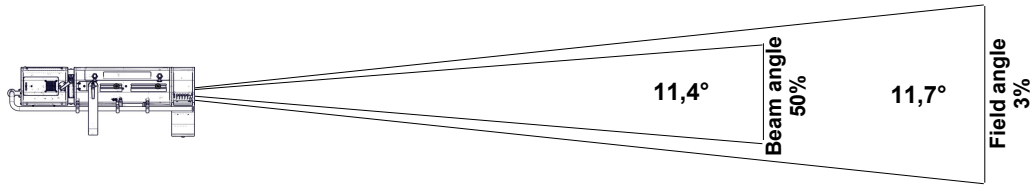

Distance	5 m	10 m	15 m	20 m	25 m	30 m
Field diameter	1 m	2 m	3,1 m	4,1 m	5,1 m	6,1 m
Illumination	8 700 lux	2 200 lux	960 lux	540 lux	350 lux	240 lux
Distance	15 ft	35 ft	50 ft	65 ft	80 ft	100 ft
Field diameter	3,1 ft	7,2 ft	10,2 ft	13,3 ft	16,4 ft	20,5 ft
Illumination	960 fc	180 fc	90 fc	55 fc	34 fc	22 fc

• Optics @ 17°

Field lumens	Beam lumens	Efficacy	Beam intensity	CCT	Delta uv
7 190 Lm	5 640 Lm	26 Lm/W	158 400 Cd	3 170 K	

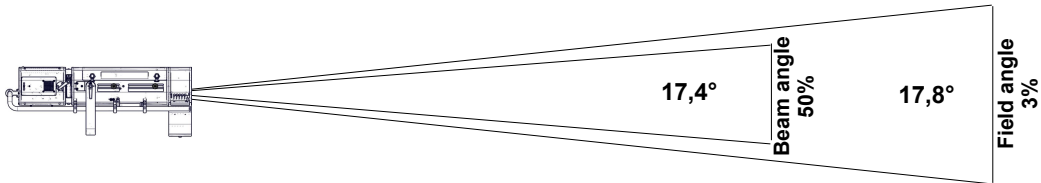

Distance	5 m	10 m	15 m	20 m	25 m	30 m
Field diameter	1,6 m	3,1 m	4,7 m	6,3 m	7,8 m	9,4 m
Illumination	6 400 lux	1 600 lux	710 lux	400 lux	260 lux	180 lux
Distance	15 ft	35 ft	50 ft	65 ft	80 ft	100 ft
Field diameter	4,7 ft	11 ft	15,7 ft	20,4 ft	25,1 ft	31,3 ft
Illumination	710 fc	130 fc	65 fc	38 fc	25 fc	16 fc

• Optics @ 22,5°

Field lumens	Beam lumens	Efficacy	Beam intensity	CCT	Delta uv
6 340 Lm	4 830 Lm	23 Lm/W	90 000 Cd	3 160 K	

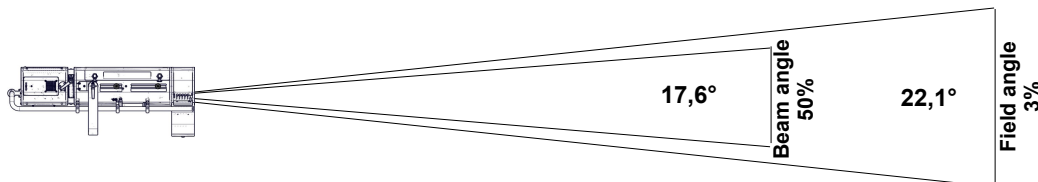

Distance	5 m	10 m	15 m	20 m	25 m	30 m
Field diameter	2 m	3,9 m	5,9 m	7,8 m	9,8 m	11,7 m
Illumination	3 650 lux	910 lux	410 lux	230 lux	150 lux	105 lux
Distance	15 ft	35 ft	50 ft	65 ft	80 ft	100 ft
Field diameter	5,9 ft	13,7 ft	19,5 ft	25,4 ft	31,2 ft	39,1 ft
Illumination	410 fc	75 fc	37 fc	22 fc	15 fc	10 fc